



SAFETY AT THE HIGHEST LEVEL

KEE WALK® Instructions for Use Manual

Also with Guardrail



SECTION	CONTENTS	PAGE
1	INTRODUCTION	1
1.1	Validity	1
1.2	Authorised Agent	1
1.3	Health and Safety	1
1.4	Familiarisation	1
1.5	Certifying Body	1
1.6	Anticipated Life	1
1.7	Safeguarding The Instruction For Use Manual	1
1.8	Copyright	1
1.9	Amendment Service	1
1.10	Modifications To The KEE WALK System	1
1.11	Definition “Authorised Person”	1
1.12	Definition “Trained Person”	1
1.13	Use In Accordance with Regulations	1
1.14	Incorrect Use	3
1.15	Operator’s Duty Of Care	3
1.16	Atmospheric Conditions	3
2	BASIC SAFETY INSTRUCTIONS	4
3	SYSTEM PLANNING, ASSEMBLY & INSTALLATION	5
3	Installation	5
3.1	Tool List	5
3.2	Checking The Walkway systems	5
4	Layout	20
5	KEE WALK WITH GUARDRAIL	25
5.1	Components	26
5.2	KEE WALK With Guardrail Conversion Chart	27
5.3	How To Choose Your Guardrail	28
5.4	Fitting Guide	29
5.4.1	Retro Fitting Guide	29
5.4.2	Standard Fitting Guide	30
5.5	End And Gate Detail Options	33
6	FINAL INSPECTION	35
7	RECERTIFICATION	36
8	TRANSPORT	37
9	MARKINGS ON THE PRODUCTS AND THEIR MEANING	37



1. INTRODUCTION

1.1 Validity

These operating instructions apply to the following product:

Type: KEE WALK Walkway system with/without Guardrail
 Model Year: 2016 & 2018

1.2 Authorised Agent

Kee Safety Shanghai
 16AB Sino-Ocean Tower,
 588 Yan An East Road
 Shanghai, China
 Tel: +86 400 820 9261
 E-Mail: chnsales@keesafety.com
 Internet: www.keesafety.cn

1.3 Health and Safety

Installers and users must comply with all relevant health and safety regulations in their given territory.

1.4 Familiarisation



Before using KEE WALK for the first time it is recommended that the installers attend a Kee Safety installation course.

1.5 Certifying Body KEE WALK Walkway

Lucideon
 Queens Road, Penkhull
 Stoke-on-Trent, ST4 7LQ

1.6 Anticipated Life

Metal Components: Up to 25 years in non-marine, non-corrosive (e.g. chemical plant) environments with a temperature range from -10 to + 55 degrees centigrade subject to use and a mandatory annual inspection strictly in accordance with these instructions.

1.7 Safeguarding the Instruction Manual

This Instructions for Use document forms a component part of the KEE WALK system. It must accompany the system and be followed for assembly. At no time must any pages be removed from these instructions. If the instructions are lost in their entirety or in part, the instructions or the missing parts must be replaced immediately.

1.8 Copyright

This documentation contains information protected by copyright. It may not be photocopied, reproduced, translated or recorded on data media, either completely or as extracts, without prior permission. We reserve all further rights.

1.9 Amendment Service

This document is not subject to any amendment service from the manufacturer. Amendments to

this documentation can't be carried out without prior notice.

1.10 Modifications to The KEE WALK system

If you undertake modifications to the KEE WALK system, you will negate all certification that comes with this product.

1.11 Definition "Authorised Person"

A person is deemed to be an authorised person if they have fully read and understood the instructions provided in this manual.

1.12 Definition "Trained Person"

Trained persons, are persons who, based on their specialist training and experience have adequate knowledge of the system to be checked and are sufficiently familiar with the relevant regulations, guidelines and generally recognised rules of the KEE WALK system and accompanying regulations - e.g., Health and Safety Regulations and Accident Prevention Regulations that are in force in the country of use; and can assess the safe working conditions of the installation location. A trained person shall be responsible for selecting all users of The KEE WALK system.

1.13 Use in Accordance with Regulations

The Walkway system provides an access walkway for level and inclined metal profile roofs which are not accessible to the public but to which access is required for the purpose of carrying out repairs and maintenance.

The Walkway system is designed as a permanently installed system. However, dismantling and reconstruction at a different location is permissible under certain circumstances.

The Walkway system is only regarded as being used for its intended use if all the following conditions are met:

The Walkway system is governed by various workplace Regulations and Guidelines. Operating personnel must be familiar with the statutory requirements arising from these. They must also be familiar with and adhere to the following specifications and technical regulations:

- HSG-33, Health & Safety in Roof work,
- HSE INDG 284- Working on Flat Roofs
- BS EN 516 : 2006
- The total weight of the Walkway system depends on the length and configuration of the whole system. The load-bearing capacity of the roof must at least correspond to the total weight of the system plus potential personnel. If in doubt, you must arrange for the roof structure to be examined by a structural engineer before assembly.
- The Walkway system must be linked to the building's lightning protection system if possible.
- The Walkway system is only designed for use on those specified in the assembly instructions. The maximum permissible pitch of the roof is 35° from the horizontal.
- When operating the system care is necessary when the wind speed is in the region of 17 m.p.h. (gusting to 26 m.p.h. or over). All operations being carried out in the vicinity of the Walkway system should cease when the average (mean) wind speed reaches 23 m.p.h. (gusting to 35 m.p.h. or over).
- The roof must be free from algae, stones, oil, grease, water accumulation and loose debris.

1.14 Incorrect Use

The following points are classed as misuse although the type of use appears possible at first glance:

- Use of the Walkway system if one of the conditions specified under “intended use” is not met.
- Failure to observe the weights and conditions relating to the roof surface specified under “intended use”. If the conditions specified are not adhered to, then the Walkway system may possibly fail.
- Use of a damaged Walkway system or one which has been assembled incorrectly or is incomplete.
- Should the Walkway system be used in spite of these instructions, then the possibility of a fall occurring and severe or fatal injury is possible.

Use of The KEE WALK system in any of the above conditions is forbidden

1.15 Operator’s Duty of Care

The duties and obligations of the operator and trained personnel when dealing with The KEE WALK system are set out below.

a) Safety of The KEE WALK system

In particular, the owner or employer must ensure that the Walkway system

- is only used as intended,
- is only provided in a fault-free, reliable state,
- is checked regularly,

b) Instruction and Training

All users of the system must ensure that:

- before using the system for the first time and at least once annually thereafter, all personnel shall be instructed in all relevant matters of health and safety at work (with particular emphasis on Working at Height) and environmental protection.
- the operating instructions are always available in a legible state, are complete and are kept with the system at all times.
- all users are familiar with the contents of these operating instructions.

The requirements the manufacturer places on the users of The KEE WALK system are as follows:

c) Duties of the User

The user must fulfil the following duties:

- Assemble The KEE WALK system strictly in accordance with this Instructions for Use Manual and check that the system is functioning correctly and safely.
- Recognise any defects and withdraw the system from use and alert the manufacturer so an assessment and required repairs can be completed.

d) Requirements of the User

In order to be able to fulfil his or her duties, the user must meet the following requirements:

- They must have adequate knowledge of the language in use in the country where the system will be installed
- They must be free from any disability that may affect their ability to use this system or understand these instructions.
- It is unlikely that any medical condition may directly affect (or be affected by) the use of this product in itself, but users must be aware that:
 - Working at height is a dangerous occupation. They should be trained to do so, and should comply with any medical requirements set by the training provider.



1.16 Atmospheric Conditions

CARE TO BE EXERCISED!

This rooftop walkway should never be used during periods when there is frost, ice or snow on the roof, or if these conditions are imminent.



2. BASIC SAFETY INSTRUCTIONS

Basic safety instructions for the safe handling of the KEE WALK system can be found here.

DANGER TO LIFE!



It is imperative that you follow these safety instructions to avoid endangering your life and safety.

Possible Danger	Prevention Measures
<p>DANGER TO LIFE! There is a risk of the construction personnel falling during assembly or when carrying out repairs.</p> <p>Explanation: Inadequate or insufficient safety measures or errors during the assembly of the Walkway system can lead to falls resulting in severe/fatal injuries.</p>	<ul style="list-style-type: none"> • The Walkway system is only to be assembled as specified in the assembly instructions. • After assembly or after carrying out repairs, check all structural parts and connecting components to make sure that they are located correctly. • Do not use any parts that are damaged.
<p>DANGER TO LIFE! There is a risk of the Walkway system failing if the installation site is unsatisfactory</p> <p>Explanation: A non-approved roof surface can result in The Walkway system sliding and failing.</p>	<ul style="list-style-type: none"> • Follow the detailed information provided in this document. If in doubt please contact us. • The roof surface must always be of the prescribed quality and load-bearing capacity. • The prescribed measures must always be complied with.
<p>DANGER TO LIFE! There is a risk of people falling due to failure to carry out maintenance work on the Walkway system.</p> <p>Explanation: Defects or damage can impair the function of the Walkway system therefore the system may possibly not be guaranteed in the event of an emergency.</p>	<ul style="list-style-type: none"> • If you have to carry out repairs on the roof or any plant always carry out a visual check on the Walkway system and the roof area beforehand for damage. • Any parts that are found to be damaged, must always be replaced before any work is started. Only then is it permitted to start the actual work on the roof.
<p>DANGER TO LIFE! There is a risk of people falling due to attaching Personal Protection Equipment to a Walkway system</p> <p>Explanation: The Walkway system must never be used to attach P.P.E. to as an anchor for abseiling or similar work.</p> <p>The imposed lateral load of the whole system may be reduced as a result of the process of reconstruction</p>	<ul style="list-style-type: none"> • The Walkway system is a stand alone, maintenance Walkway system and should always be treated as such. Under no circumstances should the system be used as a "man anchor" or as a connection for P.P.E. • Always use new Fixings when re-installing any new walkway.

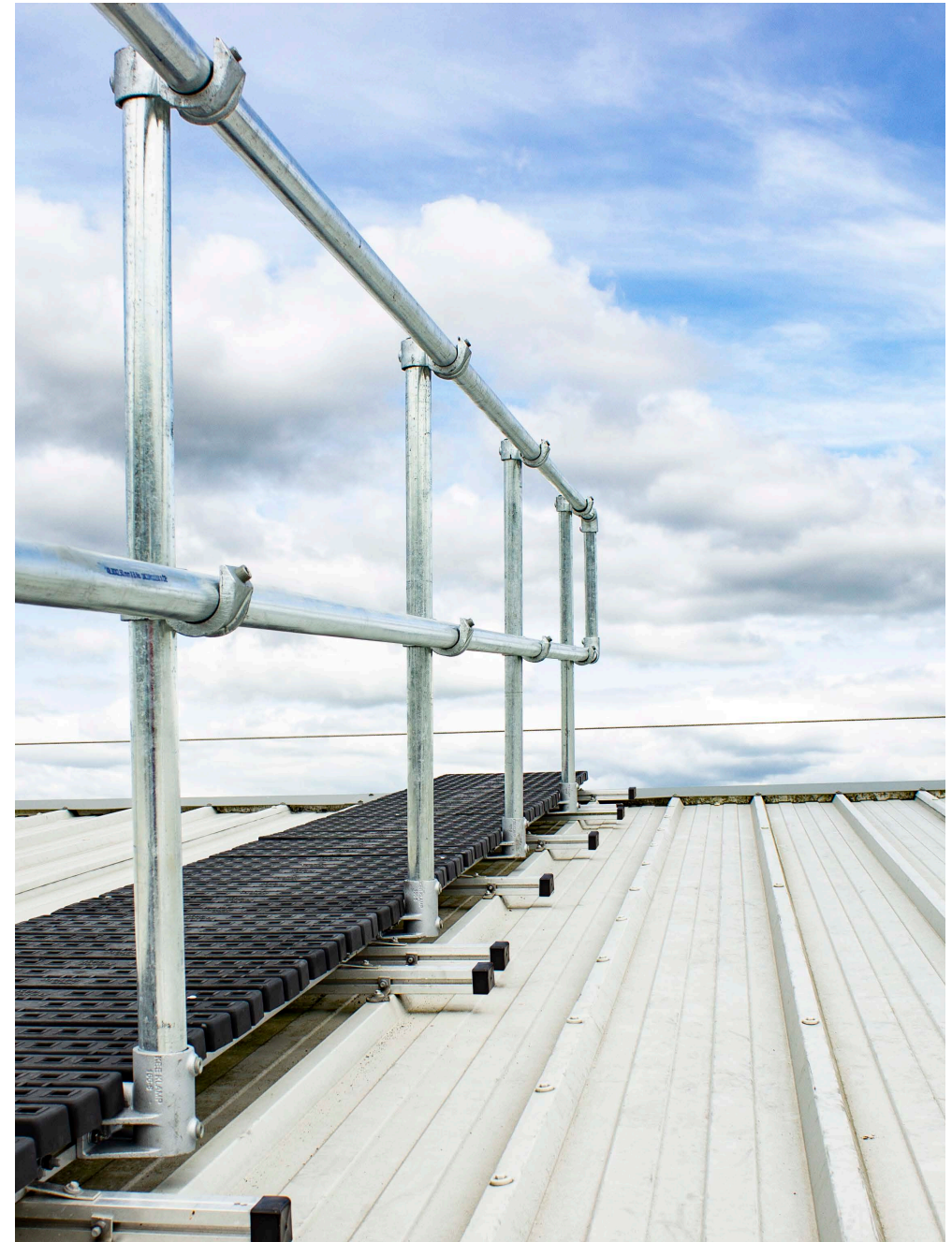

3. INSTALLATION

During installation at least two people should be on the roof at all times. Prior to the Walkway system being erected, all personnel on the roof should ensure they stay at least 2m from the edge of the roof at all times.

Installers should wear and use:

- EN 354 (Lanyards)
- EN 355 (Energy absorbers)
- EN 360 (Retractable type fall arresters) (> prEN 360:2016)
- EN 361 (Full body harnesses)
- EN 353-2 (Guided type fall arresters including a flexible anchor line)
- EN 358 (Belts for work positioning and restraint and work positioning lanyards)
- A full body harness to EN361 is the only acceptable form of body holding device for fall arrest systems.

The full body safety harness and lanyard should be suitably attached to a safe anchor point at all times.

- Installers and users must comply with all relevant health and safety regulations.

3.1 Tool List

- Deep socket 8mm / hacksaw
- Torque wrench 10- 60 Nm approx.
- Power drill with suitable 5 & 8mm drill bits
- Tape measure / marker pen
- Metal cutting chop saw (on site specials)
- Level / magnetic plum line
- Pop riveter (on site special stair cases only)
- Impact driver for 8mm socket
- 13mm socket
- 13mm spanner
- 5/16 A/F allen key or socket
- 1/4 A/F allen key or socket
- 8mm deep socket or dedicated tek screw bits
- 17mm sockets + spanner

3.2 Checking the Walkway system's components



If some of the parts listed in the parts list or on the delivery note are missing or damaged, then you must replace them with original parts. Contact the manufacturer to obtain these.

Note: A complete list of all parts and details on the total weight of the KEE WALK walkway system are provided with the delivery. The load-bearing capacity of the roof must be equal to or exceed the capacity specified.

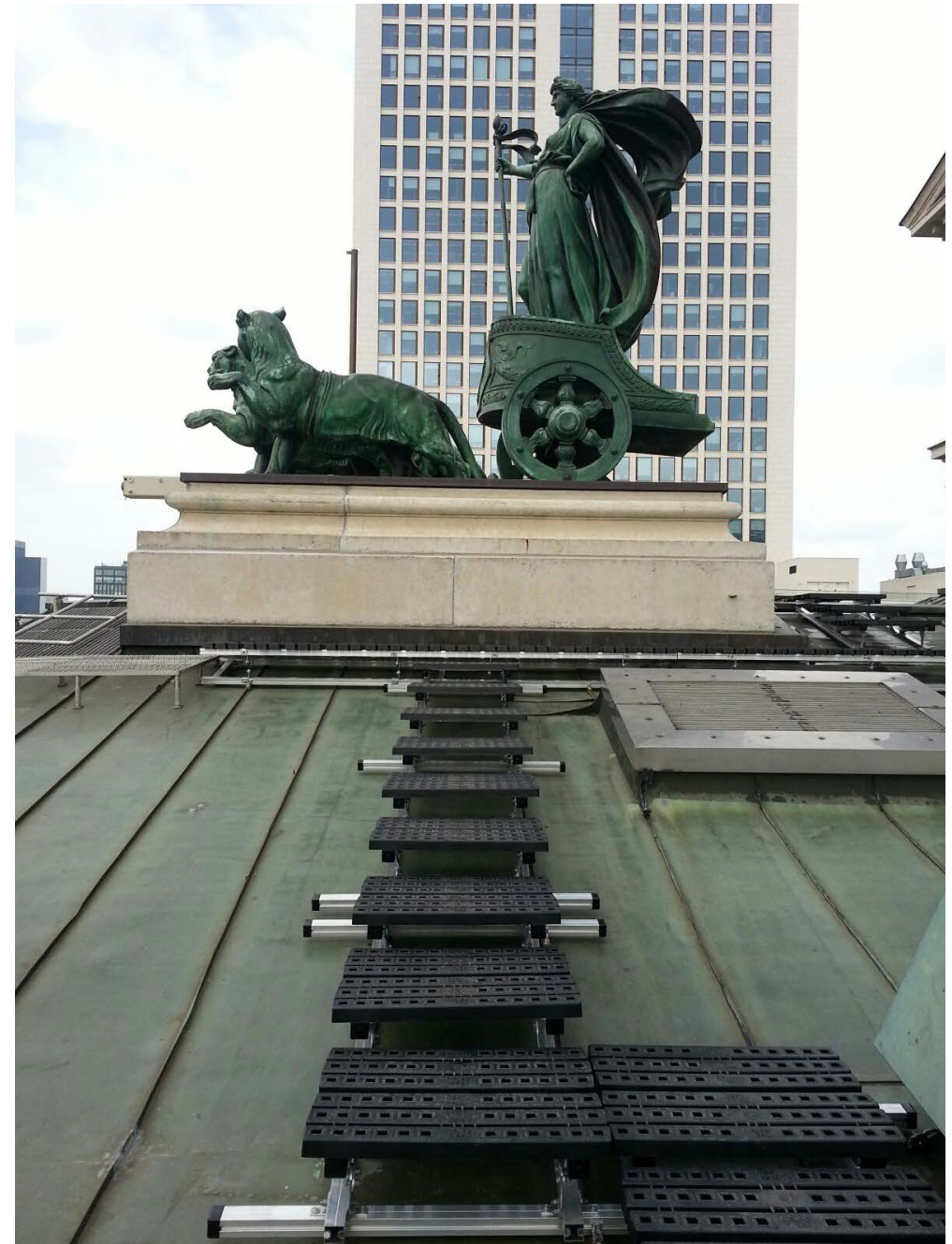

Checking the Walkway System's Components

Designation and function of the components for standard systems

The Walkway system consists of the following modules & individual components. The exact number of individual components depends on the length and construction of the Walkway system.

Note: A complete list of all parts and details on the total weight of the fall prevention system are provided with the delivery. The load-bearing capacity of the roof must be equal to or exceed the capacity specified.

Grey = Nylon Treads with Galvanised Fixings

Magenta = Nylon Treads with Stainless Steel Fixings

Blue = Aluminium Treads with Stainless Steel Fixings



1.5m Traverse Module 5 to 10 Degree Slopes – KWM4 - WW704ASSY
KWM4SS - WW804ASSY

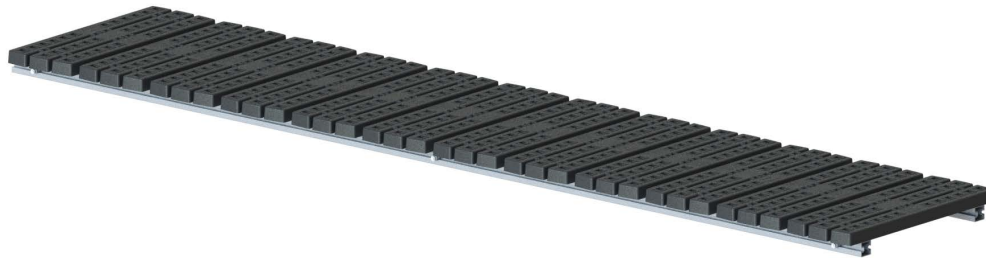

3m Traverse Module for Up to 5 Degree Slopes – KWM1 - WW701ASSY
KWM1SS - WW801ASSY



3m Traverse Module 10 to 15 Degree Slopes – KWM5 - WW705ASSY
KWM5SS - WW805ASSY



1.5m Traverse Module for Up to 5 Degree Slopes – KWM2 - WW702ASSY
KWM2SS - WW802ASSY



1.5m Traverse Module 10 to 15 Degree Slopes – KWM6 - WW706ASSY
KWM6SS - WW806ASSY



3m Traverse Module 5 to 10 Degree Slopes – KWM3 - WW703ASSY
KWM3SS - WW803ASSY

Checking the Walkway System's Components



3m Traverse Module 15 to 35 Degree Slopes – KWM7 - WW707ASSY
KWM7SS - WW807ASSY



1.5m Longitudinal Module up to 5 Degree Slopes – KWM10 - WW710ASSY
KWM10SS - WW810ASSY



1.5m Traverse Module 15 to 35 Degree Slopes – KWM8 - WW708ASSY
KWM8SS - WW808ASSY



3m Steps Module 5 to 10 Degree Slopes – KWM11 - WW711ASSY
KWM11SS - WW811ASSY

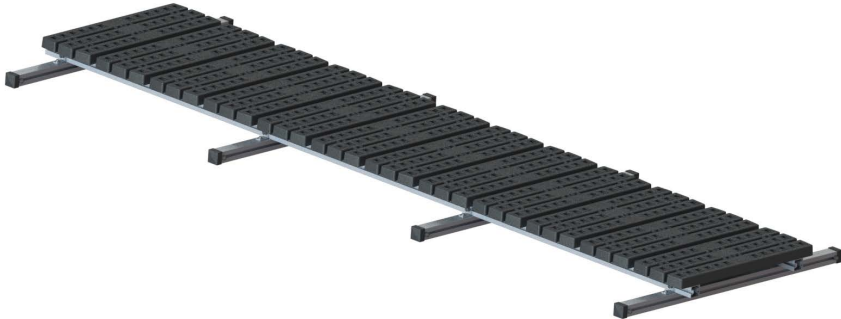

3m Longitudinal Module up to 5 Degree Slopes – KWM9 - WW709ASSY
KWM9SS - WW809ASSY



1.1m Steps Module 5 to 10 Degree Slopes – KWM12 - WW712ASSY
KWM12SS - WW812ASSY

Checking the Walkway System's Components



3m Steps Module 10 to 15 Degree Slopes – KWM13 - WW713ASSY
KWM13SS - WW813ASSY



1.5m Steps Module 15 to 25 Degree Slopes – KWM16 - WW716ASSY
KWM16SS - WW816ASSY



1.5m Steps Module 10 to 15 Degree Slopes – KWM14 - WW714ASSY
KWM14SS - WW814ASSY



3m Steps Module 25 to 35 Degree Slopes – KWM17 - WW717ASSY
KWM17SS - WW817ASSY



3m Steps Module 15 to 25 Degree Slopes – KWM15 - WW715ASSY
KWM15SS - WW815ASSY



1.5m Steps Module 25 to 35 Degree Slopes – KWM18 - WW718ASSY
KWM18SS - WW818ASSY

Checking the Walkway System's Components



3m Free Standing Module – 0° TO 5° - 75 Mph Wind – **KWM19 - WW719ASSY**
KWM19SS - WW819ASSY



1.5m Free Standing Module – 0° TO 5° - 95 Mph Wind – **KWM22 - WW722ASSY**
KWM22SS - WW822ASSY



3m Free Standing Module – 0° TO 5° - 95 Mph Wind – **KWM20 - WW720ASSY**
KWM20SS - WW820ASSY

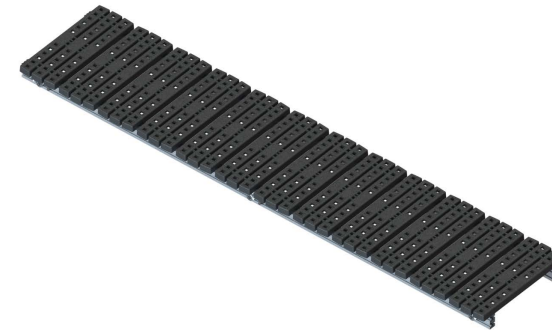

3m Raised Traverse Module for Up to 5 Degree Slopes – **KWM23 - WW723ASSY**
KWM23SS - WW823ASSY



1.5m Free Standing Module – 0° TO 5° - 75 Mph Wind – **KWM21 - WW721ASSY**
KWM21SS - WW821ASSY



1.5m Raised Traverse Module for Up to 5 Degree Slopes – **KWM24 - WW724ASSY**
KWM24SS - WW824ASSY

Checking the Walkway System's Components



0.92m Traverse Module – 0° TO 5° – [KWM25 - WW725ASSY](#)
[KWM25SS - WW825ASSY](#)



3m Traverse Module 5 to 10 Degree Slopes – [KWM3ALU - WW903ASSY](#)



3m Traverse Module for Up to 5 Degree Slopes – [KWM1ALU - WW901ASSY](#)



1.5m Traverse Module 5 to 10 Degree Slopes – [KWM4ALU - WW904ASSY](#)



1.5m Traverse Module for Up to 5 Degree Slopes – [KWM2ALU - WW902ASSY](#)



3m Traverse Module 10 to 15 Degree Slopes – [KWM5ALU - WW905ASSY](#)

Checking the Walkway System's Components



1.5m Traverse Module 10 to 15 Degree Slopes – [KWM6ALU - WW906ASSY](#)



3m Longitudinal Module up to 5 Degree Slopes – [KWM9ALU - WW909ASSY](#)



3m Traverse Module 15 to 35 Degree Slopes – [KWM7ALU - WW907ASSY](#)



1.1m Steps Module 5 to 10 Degree Slopes – [KWM12ALU - WW912ASSY](#)



1.5m Traverse Module 15 to 35 Degree Slopes – [KWM8ALU - WW908ASSY](#)



3m Steps Module 10 to 15 Degree Slopes – [KWM13ALU - WW913ASSY](#)

Checking the Walkway System's Components



1.5m Steps Module 10 to 15 Degree Slopes – [KWM14ALU - WW914ASSY](#)



3m Steps Module 25 to 35 Degree Slopes – [KWM17ALU - WW917ASSY](#)



3m Steps Module 15 to 25 Degree Slopes – [KWM15ALU - WW915ASSY](#)



1.5m Steps Module 25 to 35 Degree Slopes – [KWM18ALU - WW918ASSY](#)



1.5m Steps Module 15 to 25 Degree Slopes – [KWM16ALU - WW916ASSY](#)

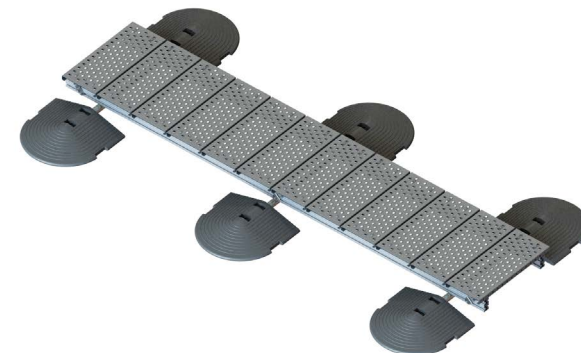

3m Free Standing Module – 0° TO 5° - 75 Mph Wind – [KWM19ALU - WW919ASSY](#)

Checking the Walkway System's Components

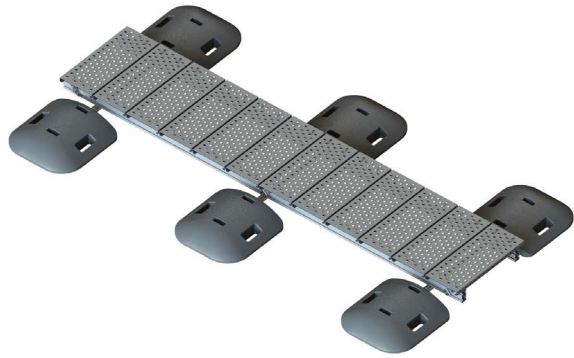

3m Free Standing Module – 0° TO 5° - 95 Mph Wind – [KWM20ALU](#) - [WW920ASSY](#)

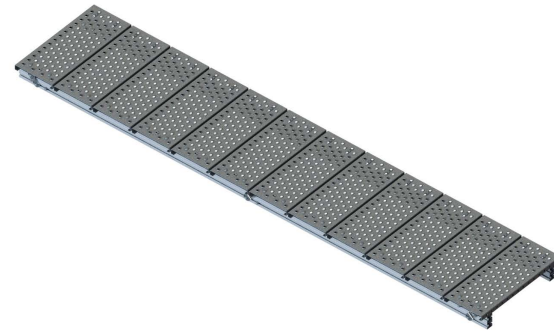

3m Raised Traverse Module for Up to 5 Degree Slopes – [KWM23ALU](#) - [WW923ASSY](#)



1.5m Free Standing Module – 0° TO 5° - 75 Mph Wind – [KWM21ALU](#) - [WW921ASSY](#)



1.5m Raised Traverse Module for Up to 5 Degree Slopes – [KWM24ALU](#) - [WW924ASSY](#)

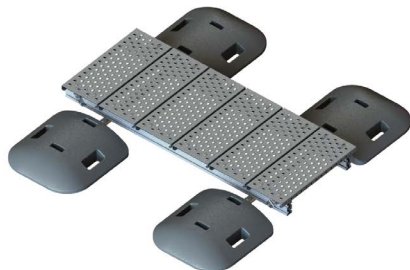

1.5m Free Standing Module – 0° TO 5° - 95 Mph Wind – [KWM22ALU](#) - [WW922ASSY](#)



Aluminium Tread – [WW1000040](#)

Checking the Walkway System's Components

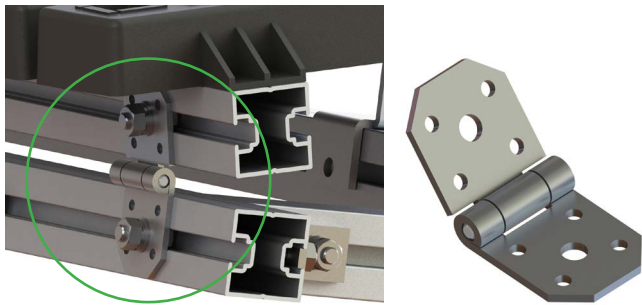

Custom Hinge – WW454ASSY

Used to construct angular adjustment in traverse frames and steps.



90° Connector – WW5353030

Used to connect bracing bars to main lower extrusions on traverse sections.

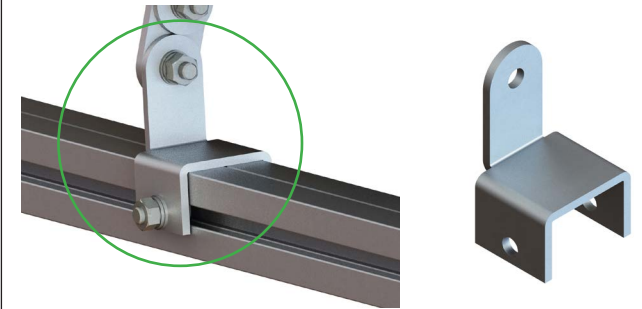

Traverse Support Plate – WW4694010

Steel connection adapter between rotating arms and main traverse extrusions.



Straight Connector – WW1003030

In-line joiner plate for connecting modules together.

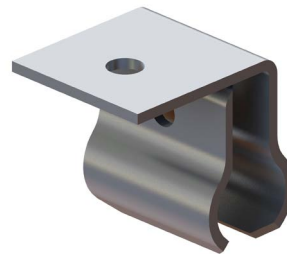

Standing Seam Clip – WW4510203 / WW4505503

Steel fixing bracket to secure module frameworks to roof.



Rotating Plates – WW3013010 / WW3013110

Steel angular adjustment brackets for traverse and step modules.

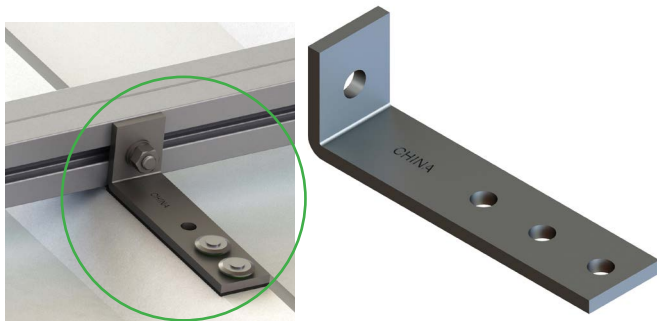

Retaining 'L' Bracket – WW3096510/WW3096530

Fixing bracket used to secure module frames to metal roof structure.



Standing Seam Bracket – WW3096510/WW3096530

Fixing bracket to extrusion adapter plate.

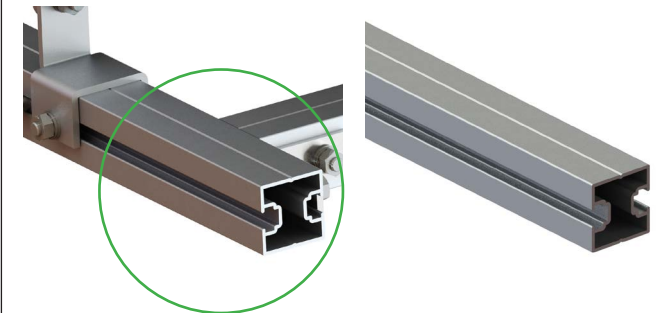

Horizontal Beam – WW4040030

Aluminium extrusion for constructing framework support.

Checking the Walkway System's Components



GRF Nylon Tread – WW1000040

Glass reinforced Nylon Moulding which forms walkway surfaces.

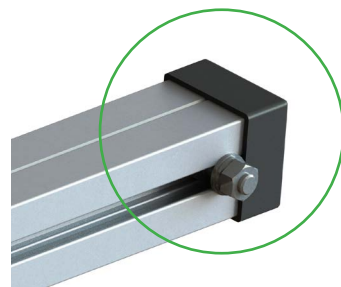

End Cap for Horizontal Beam – WW16258CP

Black Vinyl Semi flexible Plastic.



**Standing Seam Spacer Bracket – WW4096510/
WW4096530**

Spacer bracket for standing seam roof clamps.

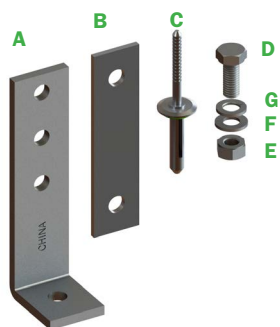

Fixing Pack 1 – Galvanised Fixings – WW760FP10

3m Traverse Module for Profile Roofs

	Part Number	Description	Qty
A	WW3096510	KW G'RAIL EXTENDED BRACKET GALV	6
B	WW1003030	STRAIGHT CONNECTOR ALUMINIUM	2
C	WW77RVT30	7.7MM RIVET WITH EPDM SEAL	12
D	WW1120110	M8 X 20 HEX HEAD SCREW GALVANISED	4
E	WW2180110	M8 HEX HD FULL NUT GALVANISED	4
F	WW3180110	M8 PLAIN WASHER FORM A GALVANISED	4
G	WW3280110	M8 Spring Washer TYPE A GALV	4

Fixing Pack 1 – Stainless Fixings – WW860FP50

3m Traverse Module for Profile Roofs

	Part Number	Description	Qty
A	WW3096530	WW3096 KW W/GUARDRAIL EXTENDED BRACKET GALV ALUMINIUM T6	6
B	WW1003030	WW1003 - STRAIGHT CONNECTOR ALUMINIUM	2
C	WW77RVT30	7.7mm RIVET WITH EPDM SEAL	12
D	WW1120150	WW1120ST - M8 x 20 A4-70 HEX HD SETSCREW ST/ST	4
E	WW2180150	WW2180ST - M8 A2-70 HEX NUT ST/ST	4
F	WW3180150	WW3180ST - M8 A4-70 PLAIN WASHER ST/ST	4
G	WW3280150	WW3280ST - M8 A4-70 SPRING WASHER ST/ST	4

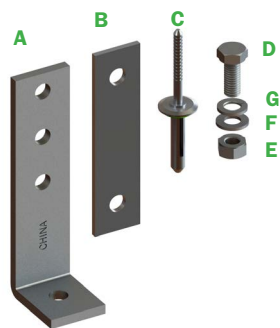

Fixing Pack 2 – Galvanised Fixings – WW761FP10

1.5m Traverse Module for Profile Roofs

	Part Number	Description	Qty
A	WW3096510	KW G'RAIL EXTENDED BRACKET GALV	4
B	WW1003030	STRAIGHT CONNECTOR ALUMINIUM	2
C	WW77RVT30	7.7mm RIVET WITH EPDM SEAL	8
D	WW1120110	M8 X 20 HEX HEAD SCREW GALVANISED	4
E	WW2180110	M8 HEX FULL NUT GALVANISED	4
F	WW3180110	M8 PLAIN WASHER FORM A GALVANISED	4
G	WW3280110	M8 SPRING WASHER TYPE A GALV	4

Fixing Pack 2 – Stainless Fixings – WW861FP50

1.5m Traverse Module for Profile Roofs

	Part Number	Description	Qty
A	WW3096530	WW3096 KW W/GUARDRAIL EXTENDED BRACKET GALV ALUMINIUM T6	4
B	WW1003030	WW1003 - STRAIGHT CONNECTOR ALUMINIUM	2
C	WW77RVT30	7.7mm RIVET WITH EPDM SEAL	4
D	WW1120150	WW1120ST - M8 x 20 A4-70 HEX HD SETSCREW ST/ST	4
E	WW2180150	WW2180ST - M8 A2-70 HEX NUT ST/ST	4
F	WW3180150	WW3180ST - M8 A4-70 PLAIN WASHER ST/ST	4
G	WW3280150	WW3280ST - M8 A4-70 SPRING WASHER ST/ST	4

Checking the Walkway System's Components

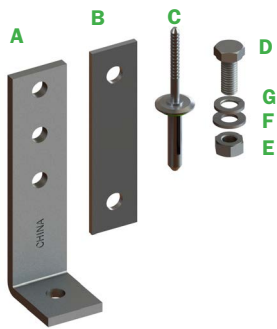

Fixing Pack 3 – Galvanised Fixings – WW762FP10
3m Longitudinal / Step Module for Profile Roofs

	Part Number	Description	Qty
A	WW3096510	KW G'RAIL EXTENDED BRACKET GALV	8
B	WW1003030	STRAIGHT CONNECTOR ALUMINIUM	2
C	WW77RVT30	7.7mm RIVET WITH EPDM SEAL	16
D	WW1120110	M8 X 20 HEX HEAD SCREW GALVANISED	4
E	WW2180110	M8 HEX HD FULL NUT GALVANISED	4
F	WW3180110	M8 PLAIN WASHER FORM A GALVANISED	4
G	WW3280110	M8 SPRING WASHER TYPE A GALV	4

Fixing Pack 3 – Stainless Fixings – WW862FP50
3m Longitudinal / Step Module for Profile Roofs

	Part Number	Description	Qty
A	WW3096530	WW3096 KW W/GUARDRAIL EXTENDED BRACKET GALV ALUMINIUM T6M	8
B	WW1003030	WW1003 - STRAIGHT CONNECTOR ALUMINIUM	2
C	WW77RVT30	7.7mm RIVET WITH EPDM SEAL	16
D	WW1120150	WW1120ST - M8 x 20 A4-70 HEX HD SETSCREW ST/ST	4
E	WW2180150	WW2180ST - M8 A2-70 HEX NUT ST/ST	4
F	WW3180150	WW3180ST - M8 A4-70 PLAIN WASHER ST/ST	4
G	WW3280150	WW3280ST - M8 A4-70 SPRING WASHER ST/ST	4

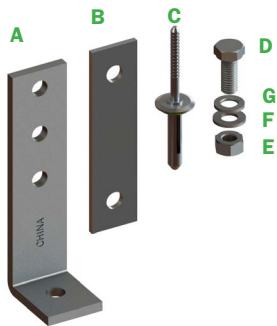

Fixing Pack 4 – Galvanised Fixings – WW763FP10
1.5m Longitudinal / Step Module for Profile Roofs

	Part Number	Description	Qty
A	WW3096510	KW G'RAIL EXTENDED BRACKET GALV	6
B	WW1003030	STRAIGHT CONNECTOR ALUMINIUM	2
C	WW77RVT30	7.7mm RIVET WITH EPDM SEAL	6
D	WW1120110	M8 X 20 HEX HEAD SCREW GALVANISED	4
E	WW2180110	M8 HEX HD FULL NUT GALVANISED	4
F	WW3180110	M8 PLAIN WASHER FORM A GALVANISED	4
G	WW3280110	M8 SPRING WASHER TYPE A GALV	4

Fixing Pack 4 – Stainless Fixings – WW863FP50
Longitudinal / Step Module for Profile Roofs

	Part Number	Description	Qty
A	WW3096530	WW3096 KW W/GUARDRAIL EXTENDED BRACKET GALV ALUMINIUM T6	6
B	WW1003030	WW1003 - STRAIGHT CONNECTOR ALUMINIUM	2
C	WW77RVT30	7.7mm RIVET WITH EPDM SEAL	6
D	WW1120150	WW1120ST - M8 x 20 A4-70 HEX HD SETSCREW ST/ST	4
E	WW2180150	WW2180ST - M8 A2-70 HEX NUT ST/ST	4
F	WW3180150	WW3180ST - M8 A4-70 PLAIN WASHER ST/ST	4
G	WW3280150	WW3280ST - M8 A4-70 SPRING WASHER ST/ST	4

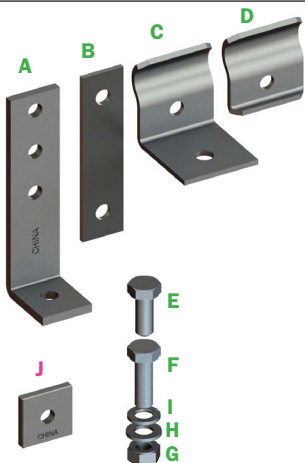

Fixing Pack 5 – Galvanised Fixings – WW764FP10
3m Traverse Module for Standing Seam Roofs

	Part Number	Description	Qty
A	WW3096510	KW G'RAIL EXTENDED BRACKET GALV	6
B	WW1003030	STRAIGHT CONNECTOR ALUMINIUM	2
C	WW4510203	STANDING SEAM RoofING CLIP (ONE HALF)	6
D	WW4505503	STANDING SEAM RoofING CLIP (2ND HALF)	6
E	WW1125110	M8 X 25 HEX HEAD SCREW GALVANISED	6
F	WW1120110	M8 X 20 HEX HEAD SCREW GALVANISED	10
G	WW2180110	M8 FULL HEX HD NUT GALVANISED	16
H	WW3180110	M8 PLAIN WASHER FORM A GALVANISED	24
I	WW3280110	M8 SPRING WASHER TYPE A GALV	16
J	WW4096510	SPACER BRACKET STEEL GALVANISED	6

Fixing Pack 5 – Stainless Fixings – WW864FP50
3m Traverse Module for Standing Seam Roofs

	Part Number	Description	Qty
A	WW3096530	WW3096 KW W/GUARDRAIL EXTENDED BRACKET GALV ALUMINIUM T6T	6
B	WW1003030	WW1003 - STRAIGHT CONNECTOR ALUMINIUM	2
C	WW4510203	WW4510 - STANDING SEAM ONE HALF	6
D	WW4505503	WW4505 - STANDING SEAM 2ND HALF	6
E	WW1125150	WW1125ST - M8 x 25 A4-70 HEX HD SETSCREW ST/ST	6
F	WW1120150	WW1120ST - M8 x 20 A4-70 HEX HD SETSCREW ST/ST	10
G	WW2180150	WW2180ST - M8 A2-70 HEX NUT ST/ST	16
H	WW3180150	WW3180ST - M8 A4-70 PLAIN WASHER ST/ST	24
I	WW3280150	WW3280ST - M8 A4-70 SPRING WASHER ST/S	16
J	WW4096530	SPACER BRACKET ALUMINIUM	6

Checking the Walkway System's Components

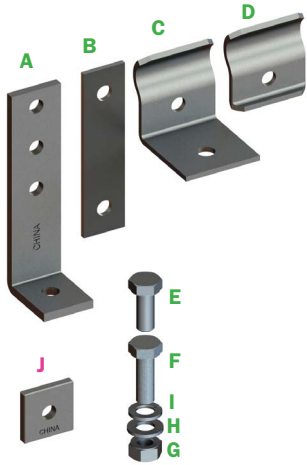

Fixing Pack 6 – Galvanised Fixings – WW765FP10

1.5m Traverse Module for Standing Seam Roofs

	Part Number	Description	Qty
A	WW3096510	KW G'RAIL EXTENDED BRACKET GALV	4
B	WW1003030	ALUMINIUM STRAIGHT CONNECTOR	2
C	WW4510203	STANDING SEAM RoofING CLIP (ONE HALF)	4
D	WW4505503	STANDING SEAM RoofING CLIP (2ND HALF)	4
E	WW1125110	M8 X 25 HEX HEAD SCREW GALVANISED	4
F	WW1120110	M8 X 20 HEX HEAD SCREW GALVANISED	8
G	WW2180110	M8 HEX HD FULL NUT GALVANISED	12
H	WW3180110	M8 PLAIN WASHER FORM A GALVANISED	16
I	WW3280110	M8 SPRING WASHER TYPE A GALVANISED	12
J	WW4096510	SPACER BRACKET STEEL GALVANISED	4

Fixing Pack 6 – Stainless Fixings – WW865FP50

1.5m Traverse Module for Standing Seam Roofs

	Part Number	Description	Qty
A	WW3096530	WW3096 KW W/GUARDRAIL EXTENDED BRACKET GALV ALUMINIUM T6	4
B	WW1003030	WW1003 - STRAIGHT CONNECTOR ALUMINIUM	2
C	WW4510203	WW45 10 - STANDING SEAM ONE HALF	4
D	WW4505503	WW4505 - STANDING SEAM 2ND HALF	4
E	WW1125150	WW1125ST - M8 x 25 A4-70 HEX HD SETSCREW ST/ST	4
F	WW1120150	WW1120ST - M8 x 20 A4-70 HEX HD SETSCREW ST/ST	8
G	WW2180150	WW2180ST - M8 A2-70 HEX NUT ST/ST	12
H	WW3180150	WW3180ST - M8 A4-70 PLAIN WASHER ST/ST	16
I	WW3280150	WW3280ST - M8 A4-70 SPRING WASHER ST/ST	12
J	WW4096530	SPACER BRACKET ALUMINIUM	4

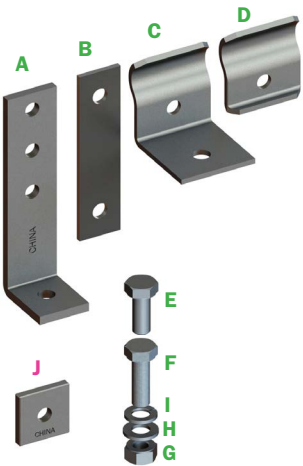

Fixing Pack 7 – Galvanised Fixings – WW766FP10

3m Longitudinal Step Module for Standing Seam Roofs

	Part Number	Description	Qty
A	WW3096510	KW G'RAIL EXTENDED BRACKET GALV	8
B	WW1003030	ALUMINIUM STRAIGHT CONNECTOR	2
C	WW4510203	STANDING SEAM RoofING CLIP (ONE HALF)	8
D	WW4505503	STANDING SEAM RoofING CLIP (2ND HALF)	8
E	WW1125110	M8 X 25 HEX HEAD SCREW GALVANISED	8
F	WW1120110	M8 X 20 HEX HEAD SCREW GALVANISED	12
G	WW2180110	M8 FULL NUT GALVANISED	20
H	WW3180110	M8 PLAIN WASHER GALVANISED	28
I	WW3280110	M8 SPRING WASHER TYPE A GALVANISED	20
J	WW4096510	SPACER BRACKET STEEL GALVANISED	8

Fixing Pack 7 – Stainless Fixings – WW866FP50

Longitudinal / Step Module for Standing Seam Roofs

	Part Number	Description	Qty
A	WW3096530	WW3096 KW W/GUARDRAIL EXTENDED BRACKET GALV ALUMINIUM T6	8
B	WW1003030	WW1003 - STRAIGHT CONNECTOR ALUMINIUM	2
C	WW4510203	WW4510 - STANDING SEAM ONE HALF	8
D	WW4505503	WW4505 - STANDING SEAM 2ND HALF	8
E	WW1125150	WW1125ST - M8 x 25 A4-70 HEX HD SETSCREW ST/ST	8
F	WW1120150	WW1120ST - M8 x 20 A4-70 HEX HD SETSCREW ST/ST	12
G	WW2180150	WW2180ST - M8 A2-70 HEX NUT ST/ST	20
H	WW3180150	WW3180ST - M8 A4-70 PLAIN WASHER ST/ST	32
I	WW3280150	WW3280ST - M8 A4-70 SPRING WASHER ST/ST	20
J	WW4096530	SPACER BRACKET ALUMINIUM	8

Checking the Walkway System's Components

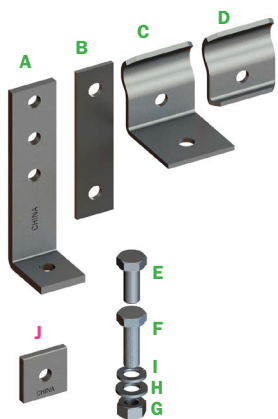

Fixing Pack 8 – Galvanised Fixings – WW767FP10

1.5m Long / Step Module for Standing Seam Roofs

	Part Number	Description	Qty
A	WW3096510	KW G'RAIL EXTENDED BRACKET GALV	6
B	WW1003030	ALUMINIUM STRAIGHT CONNECTOR	2
C	WW4510203	STANDING SEAM Roofing CLIP (ONE HALF)	6
D	WW4505503	STANDING SEAM Roofing CLIP (2ND HALF)	6
E	WW1125110	M8 X 25 HEX HEAD SCREW GALVANISED	6
F	WW1120110	M8 X 20 HEX HEAD SCREW GALVANISED	10
G	WW2180110	M8 FULL NUT GALVANISED	16
H	WW3180110	M8 PLAIN WASHER GALVANISED	22
I	WW3280110	M8 SPRING WASHER GALVANISED	16
J	WW4096530	SPACER BRACKET STEEL GALVANISED	6

Fixing Pack 8 – Stainless Fixings – WW867FP50

1.5m Long / Step Module for Standing Seam Roofs

	Part Number	Description	Qty
A	WW3096530	WW3096 KW W/GUARDRAIL EXTENDED BRACKET GALV ALUMINIUM T6	6
B	WW1003030	WW1003 - STRAIGHT CONNECTOR ALUMINIUM	2
C	WW4510203	WW4510 - STANDING SEAM ONE HALF	6
D	WW4505503	WW4505 - STANDING SEAM 2ND HALF	6
E	WW1125150	WW1125ST - M8 x 25 A4-70 HEX HD SETSCREW ST/ST	6
F	WW1120150	WW1120ST - M8 x 20 A4-70 HEX HD SETSCREW ST/ST	10
G	WW2180150	WW2180ST - M8 A2-70 HEX NUT ST/ST	16
H	WW3180150	WW3180ST - M8 A4-70 PLAIN WASHER ST/ST	22
I	WW3280150	WW3280ST - M8 A4-70 SPRING WASHER ST/ST	16
J	WW4096530	SPACER BRACKET STEEL GALVANISED	6

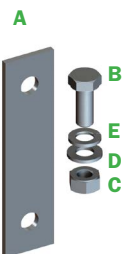

Fixing Pack 9 – Galvanised Fixings – WW758FP10

Joiners

	Part Number	Description	Qty
A	WW1003030	ALUMINIUM STRAIGHT CONNECTOR	2
B	WW1120110	M8 X 20 HEX HEAD SCREW GALVANISED	4
C	WW2180110	M8 HEX HD FULL NUT GALVANISED	4
D	WW3180110	M8 PLAIN WASHER FORM A GALVANISED	4
E	WW3280110	M8 SPRING WASHER TYPE A GALVANISED	4

Fixing Pack 9 – Stainless Fixings – WW858FP10

Joiners

	Part Number	Description	Qty
A	WW1003030	WW1003 - STRAIGHT CONNECTOR ALUMINIUM	2
B	WW1120150	WW1120ST - M8 x 20 A4-70 HEX HD SETSCREW ST/ST	4
C	WW2180150	WW2180ST - M8 A2-70 HEX NUT ST/ST	4
D	WW3180150	WW3180ST - M8 A4-70 PLAIN WASHER ST/ST	4
E	WW3280150	WW3280ST - M8 A4-70 SPRING WASHER ST/ST	4

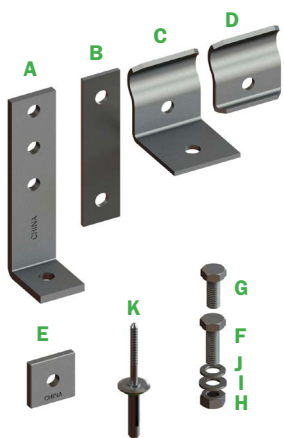

Fixing Pack Spares – Galvanised Fixings

	Part Number	Description	Qty
A	WW3096510	KW G'RAIL EXTENDED BRACKET GALV	1
B	WW1003030	ALUMINIUM STRAIGHT CONNECTOR	1
C	WW1003030	STANDING SEAM Roofing CLIP (ONE HALF)	1
D	WW4510203	STANDING SEAM Roofing CLIP (2ND HALF)	1
E	WW4505503	SPACER BRACKET STEEL GALVANISED	1
F	WW1125110	M8 X 25 HEX HEAD SCREW GALVANISED	1
G	WW1120110	M8 X 20 HEX HEAD SCREW GALVANISED	1
H	WW2180110	M8 HEX HD FULL NUT GALVANISED	1
I	WW3180110	M8 PLAIN WASHER FORM A GALVANISED	1
J	WW3280110	M8 SPRING WASHER TYPE A GALVANISED	1
K	WW77RVT30	7.7mm RIVET WITH EPDM SEAL	1

Fixing Pack Spares – Stainless Fixings

	Part Number	Description	Qty
A	WW3096530	WW3096 KW W/GUARDRAIL EXTENDED BRACKET GALV ALUMINIUM T6	1
B	WW1003030	WW1003 - STRAIGHT CONNECTOR ALUMINIUM	1
C	WW4510203	WW4510 - STANDING SEAM ONE HALF	1
D	WW4505503	WW4505 - STANDING SEAM 2ND HALF	1
E	WW4096530	SPACER BRACKET STEEL GALVANISED	6
F	WW1125150	WW1125ST - M8 x 25 A4-70 HEX HD SETSCREW ST/ST	1
G	WW1120150	WW1120ST - M8 x 20 A4-70 HEX HD SETSCREW ST/ST	1
H	WW2180150	WW2180ST - M8 A2-70 HEX NUT ST/ST	1
I	WW3180150	WW3180ST - M8 A4-70 PLAIN WASHER ST/ST	1
J	WW3280150	WW3280ST - M8 A4-70 SPRING WASHER ST/ST	1
K	WW77RVT30	7.7mm RIVET WITH EPDM SEAL	1

Installation details for the Treads

Treads are to be fixed to extrusions with 1 HEX. Flange self drilling screw fixed either side in centre holes.

All treads are to be butted against each other using tread lugs as spacers. (30mm max gap)

Treads can be cut down to suit unusual distances.

Note: The minimum going distance for step configurations in accordance with EN516 is 250mm.

Cutting Positions

Complete Tread



Examples of cutting option to Treads

Installing the 3m PLUS Walkway systems Step 1

When positioning the longitudinal walkway on composite and trapezoidal metal profiled roofs, install the pre-assembled longitudinal walkway. Position the load bearers on to the roof no more than 1500mm centres in designated area. In the case of pre-assembled units, this will already have been done.



Step 2

Remove the nut and washers from the six screws fitted on the outside of the aluminium extrusion which are not securing anything and place to one side. Apply weathering strip to underside of retaining brackets WW3096510. Place onto M8 screw and loosely secure in position with the M8 nut and M8 flat & spring washers previously taken off. Adjust position of brackets to align with crowns of roof profile. Using the 8mm drill bit, drill 2 holes into roof material, remove swarf and insert rivets to roof structure. The rivets can then be deployed. You must note the following points during assembly.



Step 3

Make sure all retaining brackets have weathering strips applied to underside, when fastening load bearers to the roof. M8 screws are torqued up to 20 Nm once the walkway is in position use a level and check the treads are within 3° of the horizontal. Make sure load bearers are long enough to straddle across at least two crowns of the profiled roofing.



4. LAYOUT



Positioning the traverse walkway Step 1 - composite and trapezoidal metal profiled roofs

Position the walkway on roof in designated area. Apply weathering strip to underside of retaining brackets. Fix Brackets to crowns of roof in suitable locations using the 8mm drill bit, drill 2 holes into roof material, remove swarf and insert rivets through bracket and into the roof structure. The rivets can then be deployed.

Fix the traverse walkway to roof profile the same way as the longitudinal versions. Remove the treads from walkway that correspond with the positions of the upside lower walkway extrusion fixing. You must note the following points during assembly:

You must note the following points during assembly:

- M8 screws are torqued up to 15 Nm once the walkway is in position

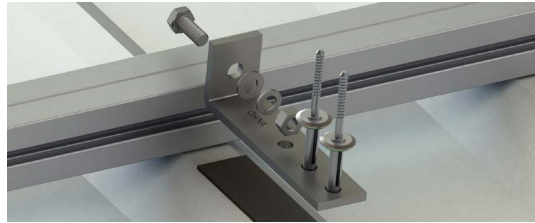

Step 2 - Setting the angle of the traverse walkway

For setting angles between 5° - 35° the following arrangements are to be used to meet various roof angles. Assembled modules will already have these in place.

For roof pitches between 2.5° - 7.5° the traverse support plates (WW4694010) are to be used with no further attachments, bolt together by means of an M8 x 25mm bolt washer and nut torqued to 20 Nm once installed.

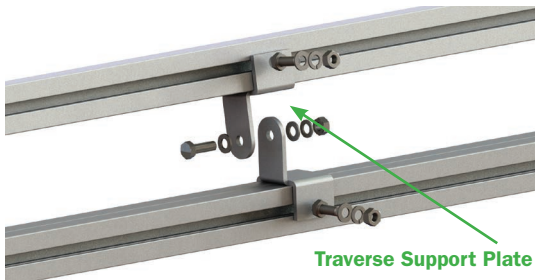

For roof pitches the between 7.5° - 15° the traverse support plates are to be used in conjunction with the Extension plate (WW3060050), bolted together by means of 2 x M8 x 25mm bolt washers and nuts torqued to 20 Nm once installed.

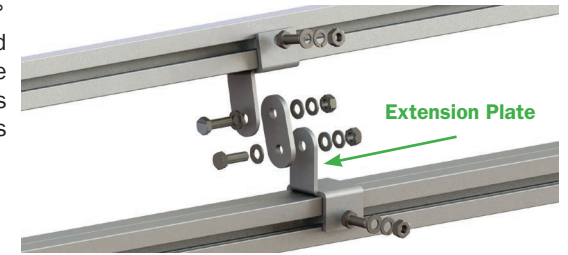

For roof pitches between 15° - 35° the traverse support plates are to be used in conjunction with the rotating arms and bolted together by means of 4 x M8 x 25mm bolt washers and nuts. The walkway should be no more than 3° from horizontal. Make sure all bolts are torqued up to 20 Nm once install complete..

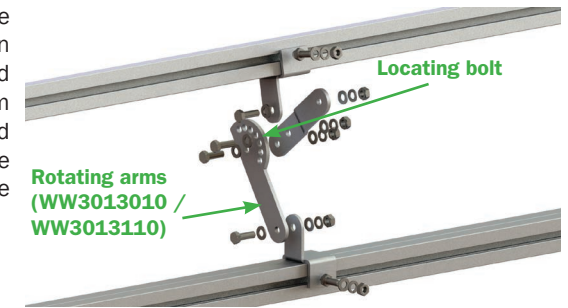

Positioning the steps walkway Step 1 - Composite and Trapezoidal metal profiled roofs

Install the pre-assembled steps walkway. Position the walkway on roof in designated area. Remove treads that are in-line with the fixing points. Apply weathering strip to underside of retaining brackets and attach to extrusion with the M8 screw, nut & washers already positioned in the extrusion. Position the retaining bracket on crown of roof profile. Using the 8mm drill bit, drill 2 holes into roof material, remove swarf and insert rivets through bracket and into the roof structure. The rivets can then be deployed. Replace the previously removed treads back in position.



You must note the following points during assembly:

- Make sure all retaining brackets have weathering strips applied to underside.
- M8 screws are torqued up to 20 Nm once the walkway is in position.

Step 2 - Setting the angle of the steps walkway

The goings should be within 3° of the horizontal when set in position with the rotating arms. Going lengths will be pre-determined in-house as lower pitch angles incorporate longer goings than high Roof pitch angles. For setting the angle, place the level onto the treads in the direction of the Roof pitch. Using the rotating arms make sure the top fixing is within 100mm of the front tread. Fix the bottom rotating arm the same distance from hinge as top fixing. Move walkway up or down to meet required angle and replace the 25mm long locating bolts found in the fixing packs through the aligned holes in the two rotating arms. The walkway should be no more than 3° from horizontal. Make sure all bolts are torqued up to 20 Nm once install complete.

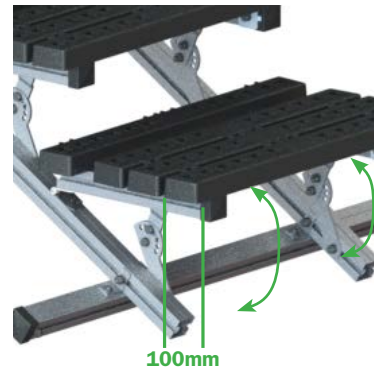

Installation diagram 3m – Longitudinal – Trapezoidal Metal Profile Roofs

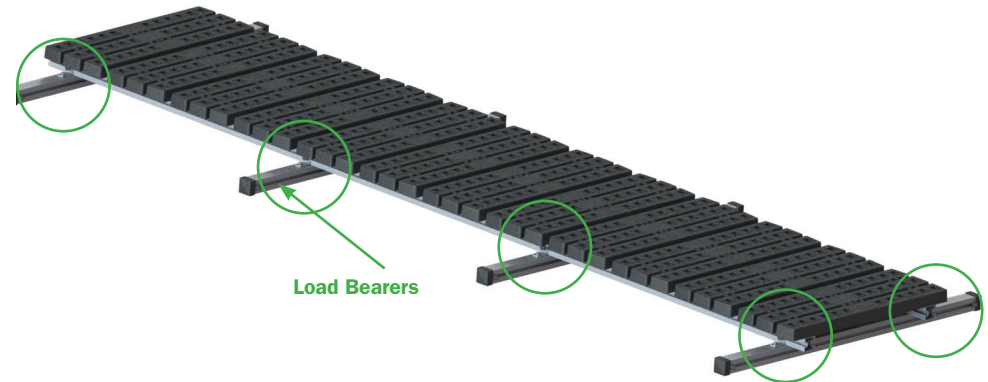

Installation fixing detail on Standing seam roofs.

Installation fixing detail on standing seam roofs. For fixing the walkway systems onto Standing Seam roofs a standing seam bracket and spacer is used. The Standing seam clips are positioned over the standing seam profile. All bolts are then to be torqued to 20 Nm



Standing seam bracket WW3096510 / WW3096530

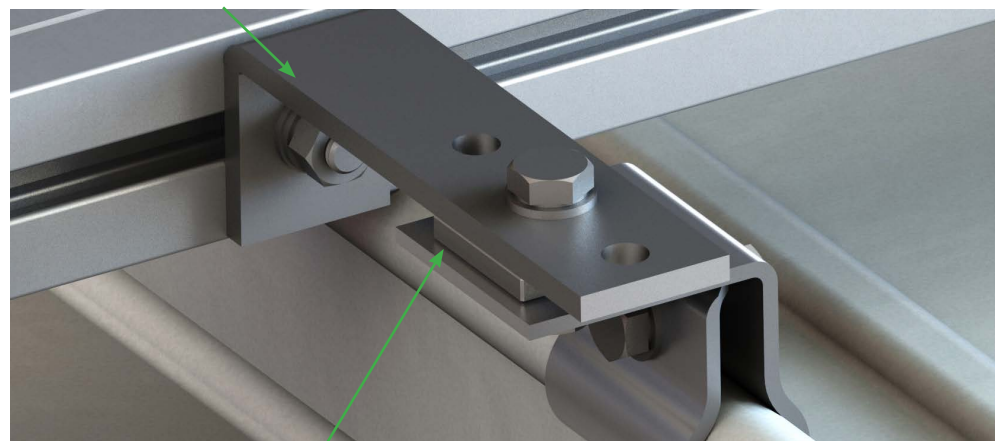

Standing seam clips (WW4505503 / WW4510203)

1) Fixing the retaining bracket to the walkway and load bearer

The load bearers are to be positioned no more than 1500mm apart. The retaining bracket is then attached to the bearer and walkway support with an M8 bolt / washer / spring washer and nut. The bracket is then attached to the load bearer with a hexagon head self drilling screw. If supplied as a module this will already have been done. For attachment to the metal profile roof attach a self adhesive sealing pad to the reverse side of the bracket, then, using the 8mm drill bit, drill 2 holes into roof material, remove swarf and insert rivets through bracket and into the roof structure. The rivets can then be deployed.

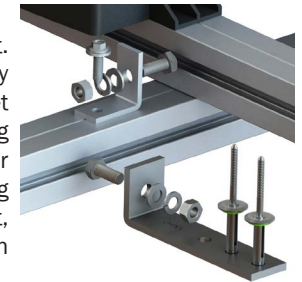

Note: Slide head of the M8 bolts into channel on side of the extrusion for fixing and torque nut to 20 Nm when in position.

2) Fixing the straight connectors

The straight connector will be fixed to the extrusions by means of 2 x M8 bolt, nuts and washers. These straight connectors are for connecting the 3m runs together.



Note: Slide head of the M8 bolts into channel on side of the extrusion for fixing and torque to 20 Nm when in position.

Installation diagram 3m – Traverse - Trapezoidal Metal Profile Roofs



1) The rotational arms allow the user to set the angle of the platform to the horizontal of the roof with ease. It's just a matter of removing the locating bolt setting the angle and replacing.

2) The retaining brackets are to be positioned no more than 1500mm apart. For attachment to the metal profile roof, attach a self-adhesive pad to the reverse side of the bracket then the fixing principal is the same as longitudinal walkway. *Note: Slide head of the M8 bolts into channel on side of the extrusion for fixing and torque nuts to 20 Nm when in position.*

3) The custom hinges allow the traverse walkway to rotate freely. The hinges will be fixed to the extrusions by means of 2 x M8 bolt / nuts/ plain washers and spring washers.

Note: Slide head of the M8 bolts into channel on side of the extrusion for fixing hinge and torque nuts to 20 Nm when in position.



Installation diagram 3m – Steps - Trapezoidal Metal Profile Roofs



1) The rotating arms allow the user to set the angle of the steps, to the horizontal with minimum fuss. It's just a matter of removing the locating bolt setting the angle and replacing.

NOTE: Step configurations will change depending on the pitch of the roof. The low-pitched roofs will incur longer goings and high-pitched roofs shorter goings (Min 250mm going). Fixing walkway to load bearers and metal profile roof is the same as for longitudinal fixing detail.

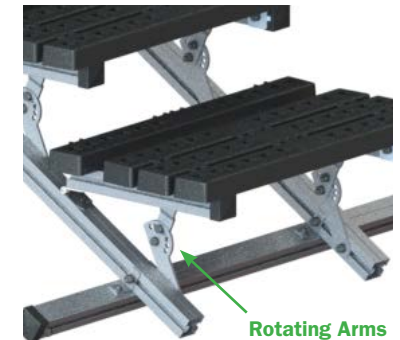

System Layout Planning, Assembly & Installation

Positioning the Free Standing Walkway

Step 1 – Flat (0 to 5) Membrane / Asphalt / Felt roofs

Install the pre-assembled walkway. Position the walkway on roof in designated area. Insert retaining collar into front recess of weight. Slide weight onto protruding tube. Tighten grub screw in collar to 39 Nm. Repeat for remaining tubes. In the case of asphalt roofs, it will be necessary to use Elastomer pads underneath the weights to prevent the weights damaging the surface of the roof.

WW719ASSY – Shown for illustration purposes

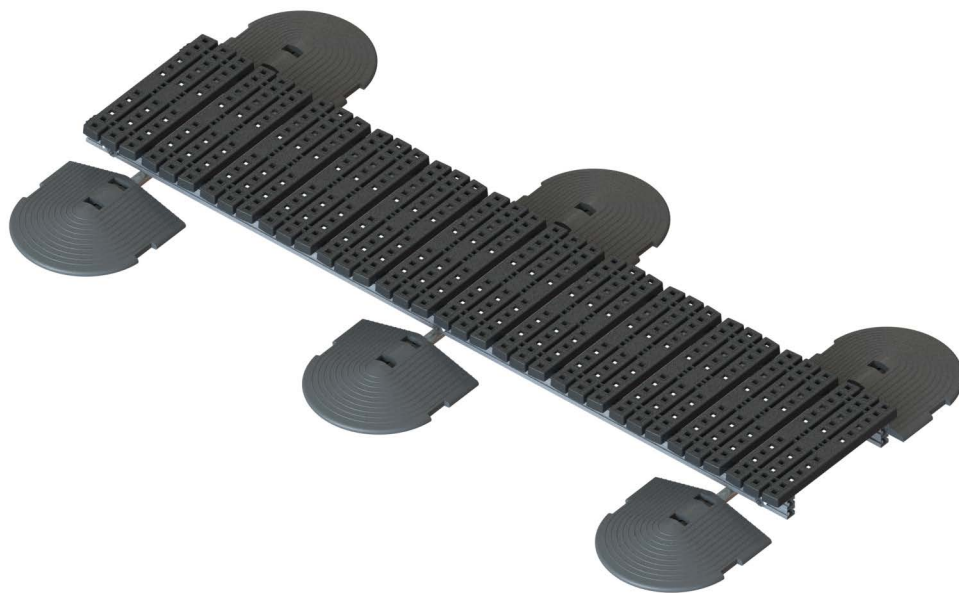

Step 2 – Subsequent Walkways

Join subsequent sections onto previously installed section in the same manner and use the straight connector between sections. When 90° corners are required it will be necessary to straddle sections between the weights. It is not necessary to join sections at corners.

Positioning the Walkway in conjunction with KEEGUARD – Flat (0° to 3°)

Membrane / Asphalt / Felt roofs.

Step 1 – Support Framework

Install the KEEGUARD system as per the relevant instructions for the product. Ensure that the KEEGUARD uprights and counter-balances are positioned as shown in the picture below. Place walkway modules on top of counter-balance tubes and secure them using the supplied brackets and hexagon head self drilling screws.

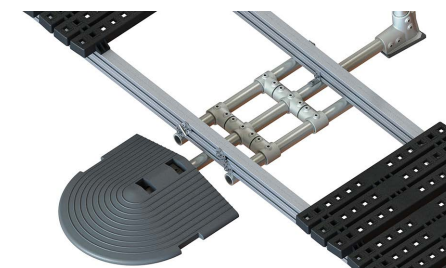
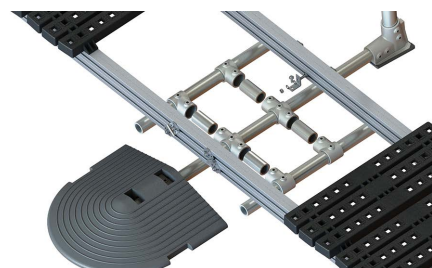
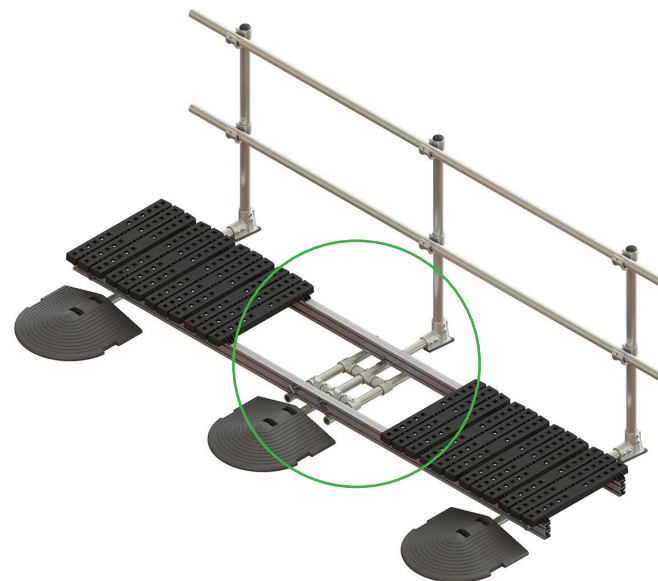

KEE WALK with Guardrail



5.1 COMPONENTS

Designation and function of the components for standard systems

The KEE WALK with Guardrail system from Kee Safety is a fall protection solution consisting of walkway and guardrail which can be installed quickly and easily on a wide variety of roofs. It is a safe, compliant to BS EN 14122, BS EN 13374, OSHA and CSA, and modular approach to guardrail protection and eliminates the fall hazard typically present when workers are exposed to an unprotected edge whilst accessing or egressing a roof top.

It consists of the below fittings and individual components. The exact number of individual components depends on the length and type of module to which the guardrail system is being fitted. All fittings are cast from malleable cast iron to BS EN 1562 and galvanised to BS EN ISO 1461 and full part numbers for reference are detailed below. Aluminium toeboard is 6063-T6 grade.

 <p>203-8</p>	 <p>204-3</p>	 <p>KWHCONBAR</p>	 <p>WW100040</p>	 <p>WW4040030</p>
 <p>14-8</p>	 <p>14-8</p>	 <p>BC53-88</p>	 <p>TB150</p>	 <p>19-8</p>
 <p>DRET</p>	 <p>TB3-7</p>	 <p>TBFP1</p>	 <p>GALV</p>	 <p>SS</p>



KEE WALK with Guardrail

5.2 CONVERSION CHART

Walkway Part No.*	Kee Walk With Handrail Upright Module				Upright Module QTY. Per Walkway	Retrofit Fixing Pack QTY. Per Walkway**	
	GALV. Single Sided Handrail Module Part No.	GALV. Double Sided Handrail Module Part No.	ALU. Single Sided Handrail Module Part No.	ALU. Double Sided Handrail Module Part No.		WWGRRF110	WWGRRF150
WW__01ASSY	WWGR1SS10	WWGR1DS10	WWGR1SS30	WWGR1DS30	2	2	2
WW__02ASSY	WWGR1SS10	WWGR1DS10	WWGR1SS30	WWGR1DS30	1	1	1
WW__03ASSY	WWGR1SS10	WWGR1DS10	WWGR1SS30	WWGR1DS30	2	2	2
WW__04ASSY	WWGR1SS10	WWGR1DS10	WWGR1SS30	WWGR1DS30	1	1	1
WW__05ASSY	WWGR1SS10	WWGR1DS10	WWGR1SS30	WWGR1DS30	2	2	2
WW__06ASSY	WWGR1SS10	WWGR1DS10	WWGR1SS30	WWGR1DS30	1	1	1
WW__07ASSY	WWGR1SS10	WWGR1DS10	WWGR1SS30	WWGR1DS30	2	2	2
WW__08ASSY	WWGR1SS10	WWGR1DS10	WWGR1SS30	WWGR1DS30	1	1	1
WW__09ASSY	WWGR1SS10	WWGR1DS10	WWGR1SS30	WWGR1DS30	2	2	2
WW__10ASSY	WWGR1SS10	WWGR1DS10	WWGR1SS30	WWGR1DS30	1	1	1
WW__11ASSY	WWGR2SS10	WWGR2DS10	WWGR2SS30	WWGR2DS30	2	2	2
WW__12ASSY	WWGR2SS10	WWGR2DS10	WWGR2SS30	WWGR2DS30	1	1	1
WW__13ASSY	WWGR2SS10	WWGR2DS10	WWGR2SS30	WWGR2DS30	2	2	2
WW__14ASSY	WWGR2SS10	WWGR2DS10	WWGR2SS30	WWGR2DS30	1	1	1
WW__15ASSY	WWGR2SS10	WWGR2DS10	WWGR2SS30	WWGR2DS30	2	2	2
WW__16ASSY	WWGR2SS10	WWGR2DS10	WWGR2SS30	WWGR2DS30	1	1	1
WW__17ASSY	WWGR3SS10	WWGR3DS10	WWGR3SS30	WWGR3DS30	2	2	2
WW__18ASSY	WWGR3SS10	WWGR3DS10	WWGR3SS30	WWGR3DS30	1	1	1
WW__19ASSY	WWGR1SS10	WWGR1DS10	WWGR1SS30	WWGR1DS30	2	2	2
WW__20ASSY	WWGR1SS10	WWGR1DS10	WWGR1SS30	WWGR1DS30	2	2	2
WW__21ASSY	WWGR1SS10	WWGR1DS10	WWGR1SS30	WWGR1DS30	1	1	1
WW__22ASSY	WWGR1SS10	WWGR1DS10	WWGR1SS30	WWGR1DS30	1	1	1
WW__23ASSY	WWGR1SS10	WWGR1DS10	WWGR1SS30	WWGR1DS30	2	2	2
WW__24ASSY	WWGR1SS10	WWGR1DS10	WWGR1SS30	WWGR1DS30	1	1	1
WW__25ASSY	WWGR1SS10	WWGR1DS10	WWGR1SS30	WWGR1DS30	1	1	1
WW730ASSY	WWGR1SS10	WWGR1DS10	WWGR1SS30	WWGR1DS30	2	2	2
WW734ASSY	WWGR1SS10	WWGR1DS10	WWGR1SS30	WWGR1DS30	2	2	2
WW735ASSY	WWGR1SS10	WWGR1DS10	WWGR1SS30	WWGR1DS30	2	2	2

* Replace '__' with 7, 8 or 9 depending on module requirement and install.

** Retrofit fitting kit - Only used on walkways not equipped with preinstalled M8 fixing bolts; 700 series walkways use WWGRFP110 (galvanised fixings) all other modules use WWGRFP150 (stainless steel fixings).

KEE WALK with Guardrail

5.3 HOW TO CHOOSE YOUR GUARDRAIL

1. Configuration

The roof type, pitch and customer's choice of tread will determine the walkway part number; the required length will determine the number of modules needed.

2. Walkway Part No:

At this point, the walkway system part number has been populated along with the required number of modules.

3. Guardrail Part No:

With your walkway module part number and quantity selected, you now need to choose your preferred guardrail option.

The choices of single or double sided guardrail in either galvanised steel or aluminum are available.

4. Upright Quantity

The quantity of upright modules required will depend upon the number of walkway modules selected at stage 2. Simply multiply the walkway quantity number by the number in the column below.

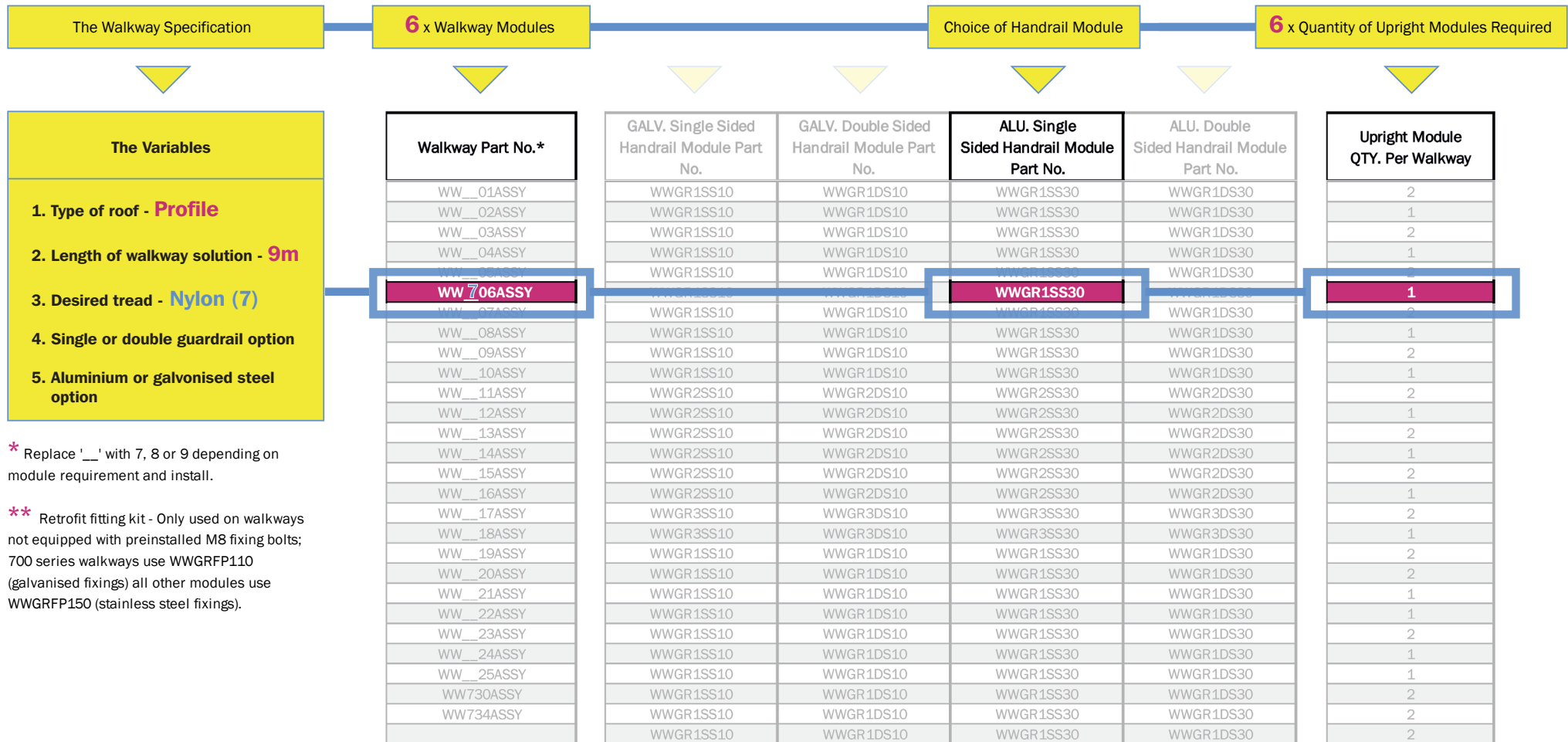

* Replace '___' with 7, 8 or 9 depending on module requirement and install.

** Retrofit fitting kit - Only used on walkways not equipped with preinstalled M8 fixing bolts; 700 series walkways use WWGRFP110 (galvanised fixings) all other modules use WWGRFP150 (stainless steel fixings).

5.4 FITTING GUIDE

5.4.1 Retro Fit

STEP 1A

Locate the position of the fitting(s) to be installed – note that on a 3m section this to be 750mm either side of centre to create a 1.5m overall baysize, on 1.5m modules this will be in the centre of the module.



STEP 1B

Using a 6mm drill bit and an electric drill, drill a pilot hole in the inboard section of the extrusion, taking care to ensure that the extrusion is not drilled through entirely; only the face on the internal side of the extrusion to which the bolt is to be inserted needs to be drilled.



STEP 1C

Using a 4mm-20mm step drill bit and an electric drill, centre the step drill bit into the extrusion using the pilot hole previously drilled and create a 14mm opening in the outward face of the extrusion.

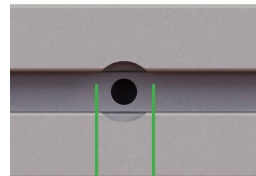

14mm

STEP 1D

Insert the M8 x 25mm screw into the extrusion, head first, and slide along into position to suit the mounting of the KEE WALK guardrail fitting. Repeat this procedure for all fittings that require fixings to be added to the extrusion for fitting of the guardrail system.



96mm

SAFETY CRITICAL! If the walkway has previously been installed without rivets and using the small aluminium bracket onto a trapezoidal roof, the fixing pack needs to be upgraded to facilitate the fixing of guardrail; this will need to be ordered separately and should be installed and specified as per the IFU for new installs.

Install four new WW3096510 brackets (including retrofitting the required M8x25mm bolts) for the trapezoidal installs **with the original fixing pack left in place**. Where an install onto standing seam installation has previously been carried out, the original aluminium bracket should be switched out for the new galvanised steel WW3096510 bracket and WW4096510 packing piece.

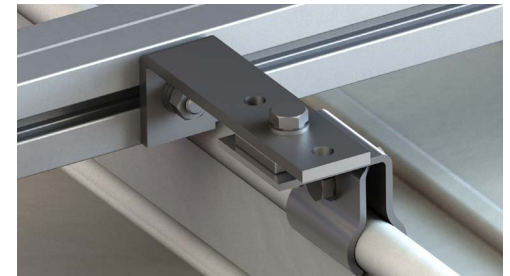
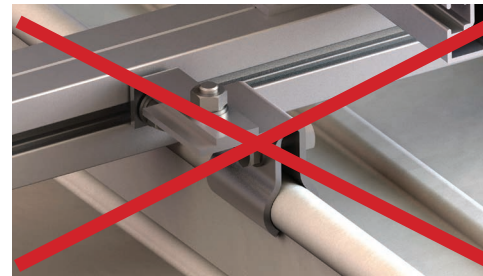
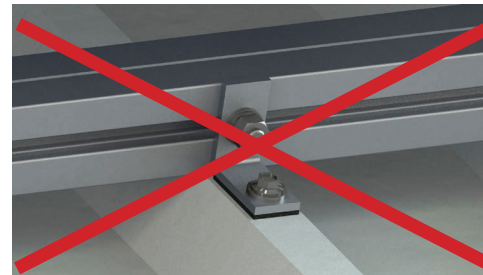

5.4.2 Standard Fit

STEP 1

Undo the self drilling screws securing the tread to the extrusion to the right of the bolts present on

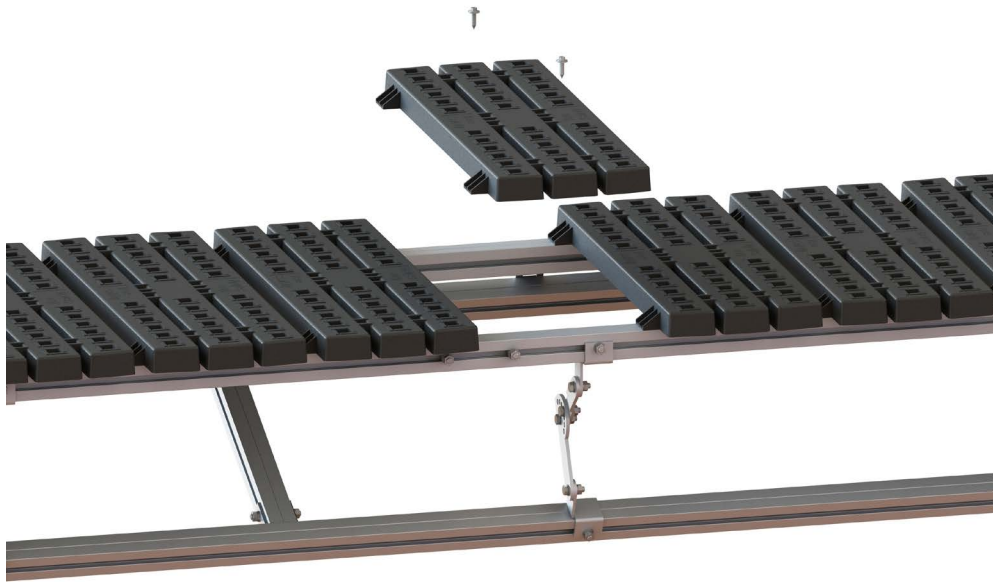

STEP 2

Locate the preinstalled nuts, bolts and washers within the extrusion, remove nuts and washers, store safely locally. Pick rearward guardrail fitting (dependant on application this could either be a 204-3 or 203-8 depending on if a single (fig. 3) or double sided (fig. 4) guardrail is desired) onto preinstalled screws, insert connection bar.

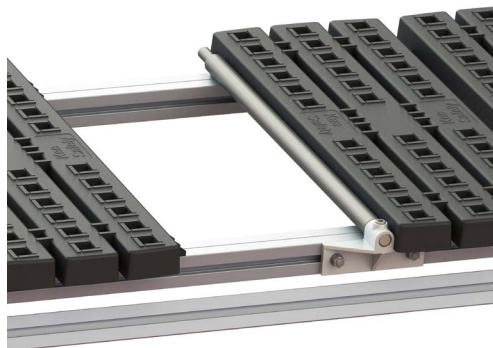

Fig 3 – single sided rearward fitting



Fig 4 – Double sided rearward fitting

STEP 3

Ensure fitting is tight against the adjacent tread, replace washers and nuts to studs and tighten to 20 Nm. Tighten grub screw in boss securing the connecting tube to 39Nm.

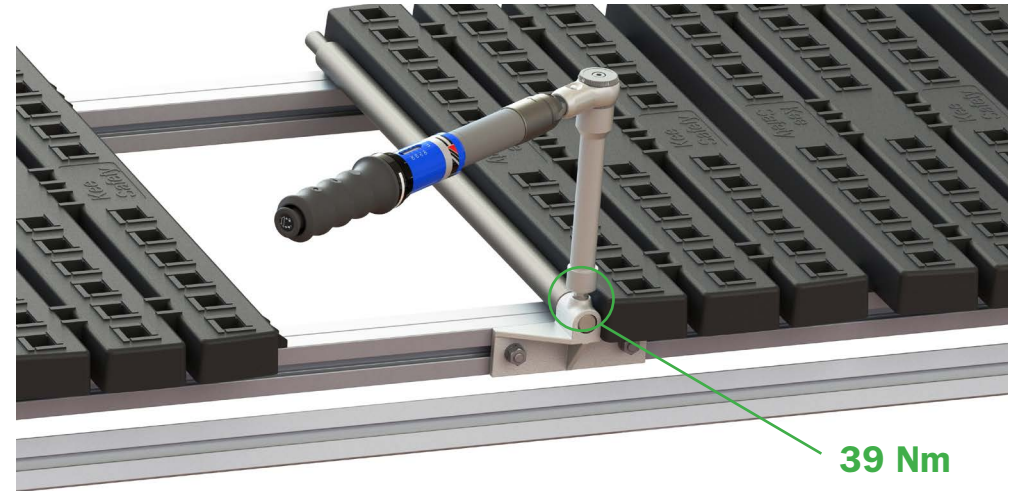

39 Nm

STEP 4

Moving to the front of the KEE WALK, locate the preinstalled nuts, bolts and washers. Remove nuts and washers, store safely locally. Whilst located on KEE WALK module, select the upright, orientate such that the 203-8 fitting is at the bottom, and locating the holes within the fitting onto the preinstalled screws and connecting bar, bring the upright assembly inwards such that the inside edge of the fitting is flat against the walkway extrusion. Ensuring the fitting is tight against the adjacent walkway tighten the grub screw within the connecting boss to 39Nm and tighten the M8 nuts to 20 Nm.

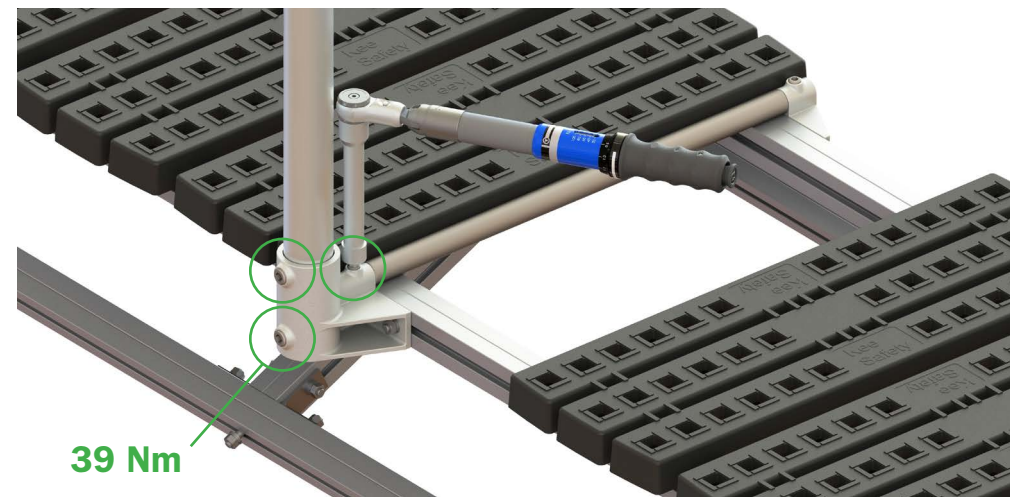

39 Nm

KEE WALK with Guardrail Fitting Guide

STEP 5

The upright is now installed, and the tread needs a small modification before refitting. The spacer bars present on the KEE WALK tread now needs to be removed in order to enable the tread to be refitted. Using a hacksaw or similar, cut the lug off close to the tread. Care must be taken here to ensure the tread isn't damaged.



STEP 6

If upon refitting an overlap is present on the adjacent tread, the procedure must be repeated for the adjacent tread. Repeat steps 2 and 6 to remove the tread, and cut off the spacer bar.



STEP 7

Refit the tread(s) with the supplied new self drilling screws, ensuring that the EPDM washer is deployed upon tightening.

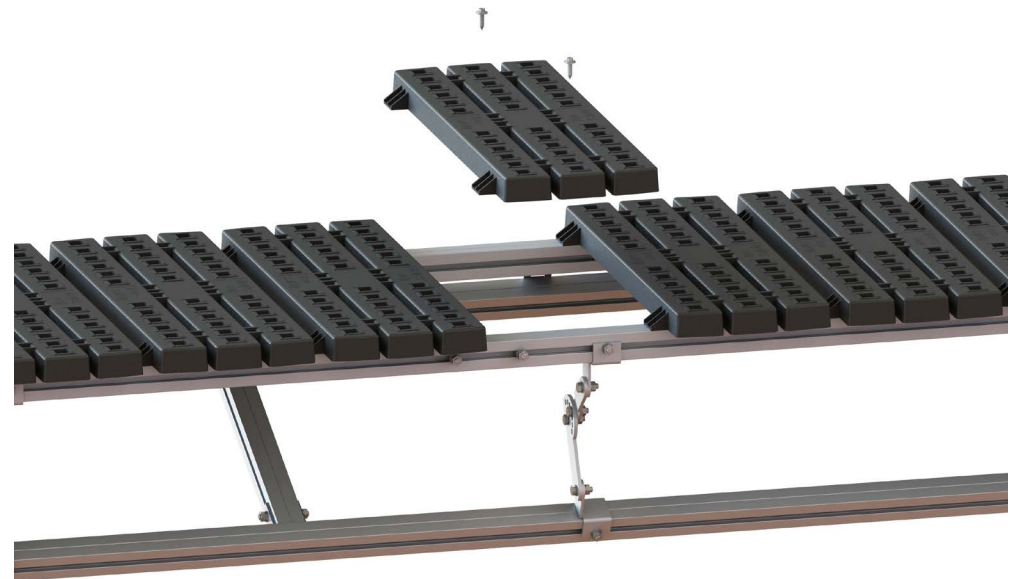

STEP 8

The upright at this location is now installed, repeat steps 1 through to 7 to install the remainder of the uprights that will make up the guardrail system.



STEP 09

Insert horizontal rails into open cup fittings, and join using 14-8 fittings as required. Note, joins in the top rail and mid rail must be staggered either side of an upright where possible. Finally tighten all remaining grub screws on the all fittings to 39Nm, and where the fittings meet extrusion on M8 connections these are torqued up to 20Nm.



IMPORTANT

It is imperative that **ALL** nuts and grub screws are tightened to the correct torque prior to using the walkway/guardrail system as improper tightening may result in the system failing and injury occurring.

OPTIONAL TOEBOARD

In order to fully comply with the BS EN 14122 standard a toe board must be fitted to all installs requiring this compliance.

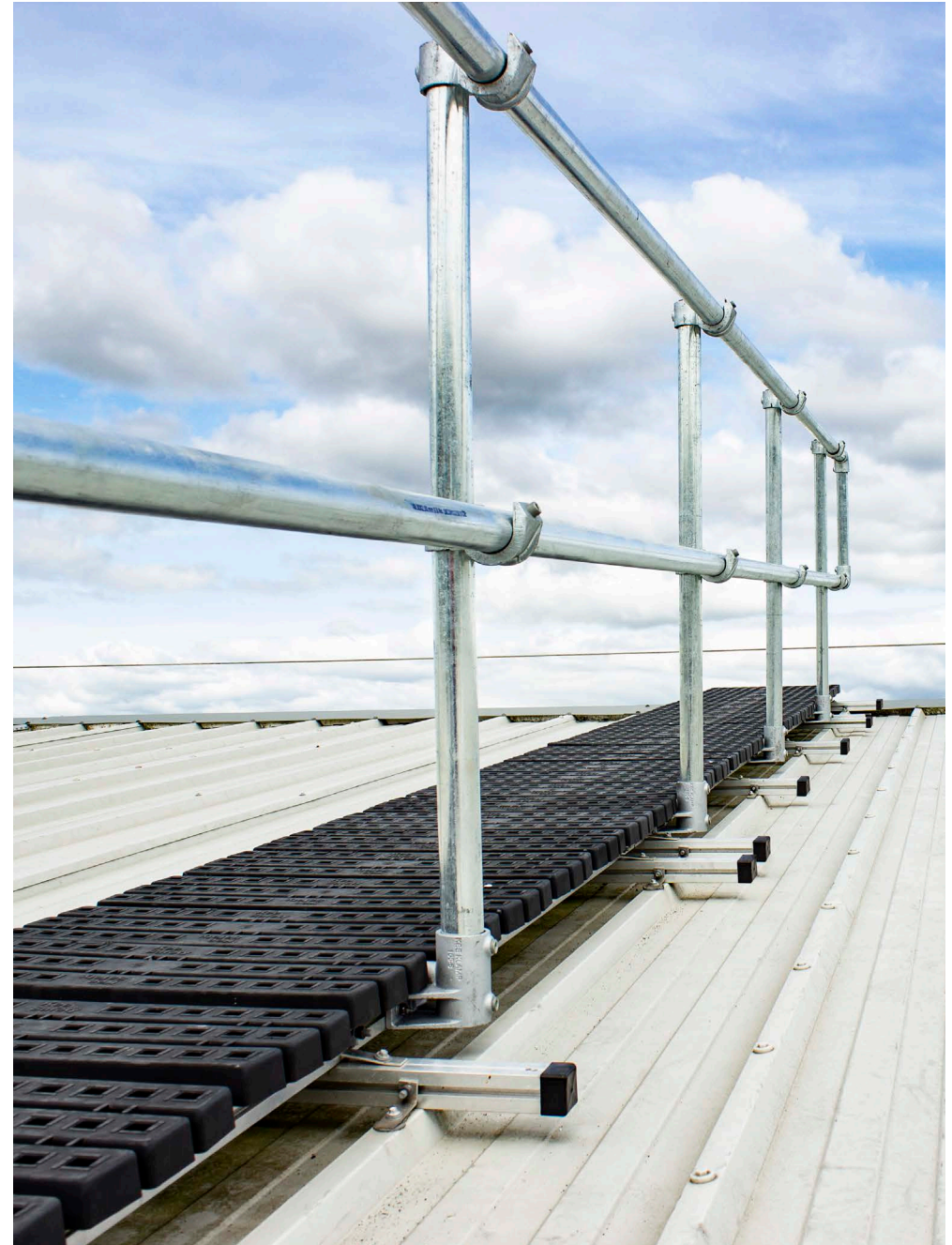
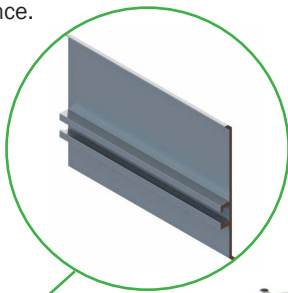

5.5 END AND GATE DETAIL OPTIONS

Shown below are the end and gate detail options available for terminating a guardrail run or adding a gated access point to a guardrail system where restriction of movement and/or protection of areas is required. The kits shown below include all the necessary fittings, cut tube and fixings to add on to any KEE WALK guardrail install in either new build or retrofit format*.

NOTE: The M8 fixings required to attach the end post fittings will need to be added, these are in the kit and simply need to be inserted into the open square end of the extrusion on the final module of the walkway system and simply slide into position. No opening needs to be made into the face of the extrusion.



Part Number	Description
WWGRRTS10	Single Guardrail - D Return



Part Number	Description
WWGRENS10	Single Guardrail - End Return



Part Number	Description
WWGRRTD10	Double Guardrail - D Return



Part Number	Description
WWGREND10	Single Guardrail - End Detail

*In all installs the final post position is located between the last and second to last tread and installed as per the standard KWGR upright (method shown earlier in this document).

KEE WALK with Guardrail

Shown below are the end and gate detail options available for terminating a guardrail run or adding a gated access point to a guardrail system where restriction of movement and/or protection of areas is required. The kits shown below include all the necessary fittings, cut tube and fixings to add on to any KEE WALK guardrail install in either new build or retrofit format*.

NOTE: The M8 fixings required to attach the end post fittings will need to be added, these are in the kit and simply need to be inserted into the open square end of the extrusion on the final module of the walkway system and simply slide into position. No opening needs to be made into the face of the extrusion.



Part Number	Description
WWGRNMR10	External Corner - Detail



Part Number	Description
WWGRGES10	Single Guardrail End Detail - Complete with Gate



Part Number	Description
WWGRGED10	Single Guardrail End Detail - Complete with Gate

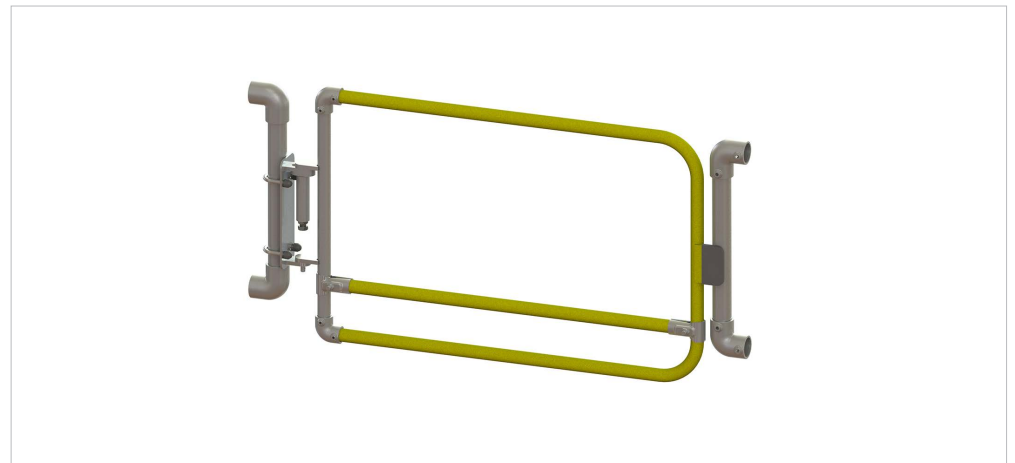

Part Number	Description
WWGRGTI10	In Line Gate Kit

*In all installs the final post position is located between the last and second to last tread and installed as per the standard KWGR upright (method shown earlier in this document).

6. FINAL INSPECTION BEFORE USE

Make a final inspection of the assembled Walkway system. Ensure that all the instructions for their installation and location have been followed. Special attention should be paid to the following:

- 1 All fasteners and bolts are correctly tightened.
- 2 All gaps between treads, are within the guidelines set in the standard, this being 30mm max.
- 3 The Walkway system is no less than 1m from the edge of the roof.
- 4 The bridging extrusions are fully in contact with the roof surface, to prevent movement.
- 5 The correct number of fixings are positioned in appropriate places when fixing down the Walkway system.
- 6 That the roof surface is of an appropriate type and angle and that the surface conditions are satisfactory (e.g. no ice, snow, frost, standing water, contamination).
- 7 Each system should be finished with the WWIDPLA01 ID plaque shown below at the start and end of the walk way

NOTE: Any unfamiliar roof surfaces and profiles unrelated to composite, trapezoidal metal profile or standing seam, please consult the technical office of your your supplier.

 <p>Safe Access Solutions HEAD OFFICE Kee Safety Limited Cradley Business Park Owensend Road Cradley Heath West Midlands B64 7DW (T) +44 (0) 1384 632188 (F) +44 (0) 1384 632192 info@keesafety.co.uk www.keesafetygroup.com</p>	<p>Maintenance Access Walkway for Level & Inclined Roofs</p> <ul style="list-style-type: none"> • Conforms to EN 516:2006 • Manufactured in England by Kee Safety • CE marking - CE 16 							
	<table> <tr> <td>INSTALLER</td> <td>SYSTEM NUMBER</td> </tr> <tr> <td><input type="text"/></td> <td><input type="text"/></td> </tr> <tr> <td>INSTALL DATE</td> <td>INSPECTION DUE</td> </tr> <tr> <td><input type="text"/></td> <td><input type="text"/></td> </tr> </table>	INSTALLER	SYSTEM NUMBER	<input type="text"/>	<input type="text"/>	INSTALL DATE	INSPECTION DUE	<input type="text"/>
INSTALLER	SYSTEM NUMBER							
<input type="text"/>	<input type="text"/>							
INSTALL DATE	INSPECTION DUE							
<input type="text"/>	<input type="text"/>							
<p>System Identification Plaque - Do Not Remove</p>								

Identification Plate – WWIDPLA01

To be placed at the start and end of each system.





KEE WALK Recertification

7. GENERAL GUIDANCE TO RECERTIFY KEE WALK

RECORDS

It is strongly recommended that a record be kept for each KEE WALK System. The record should contain headings for and spaces to allow entry of at least the details shown in the **example** below:

- Periodic inspections by a competent person are recommended by the manufacturer. In UK/Europe these are required under Regulation 5 of the Workplace (Health, Safety & Welfare) Regulations, the Work at Height Regulations and BS EN 365. The frequency will depend upon the environment, location and usage but should be at least every 6 months.
- Walk and visually inspect the complete installed system in relation to the clients' general needs. Establish if any modifications and/or additional products are required to reflect any refurbishment requirements or additional plant & equipment which have been installed and require access.
- Check installation configuration is complete as per the original installation drawing/plan.
- Ensure the system has not been modified or tampered with by unauthorised persons.
- Check all KEE WALK are in place as per the original drawing. This is essential for longevity of the roof.
- Check all fixings are in place and correctly torqued.
- Any galvanised components showing signs of corrosion should be wire brushed thoroughly and galvanised spray/paint applied as appropriate. If rusted significantly, take digital photographs and include these in the inspection report. All component and assembled parts should be kept clean, using detergent if necessary, by wiping down with a wet cloth or hosing with clean water, after which they should be wiped down with a dry cloth.
- Where toeboards are fitted check the brackets that support the toe-board are in place and sufficiently torqued.
- Where applicable check fixings to walls/structures including cat ladder clamps are in place and sufficiently torqued.
- If the KEE WALK becomes damaged in any, please arrange for inspection and any necessary repair or component replacement.

EQUIPMENT RECORD (EXAMPLE)

Name: KEE WALK Model 1/1		Type: EN516:2006	
Name and address of Authorised Agent: Kee Safety Ltd Cradley Business Park Overend Road Cradley Heath B64 7DW		Unique identification number: ***** Year of manufacture: **** Purchase date: ***** Date first put into use: *****	
Other compatible components to be used		Other compatible components to be used	
Supporting Anchors to EN795.		Full body Harness To EN361	
connectors to EN362		Fixed Length Lanyard to EN354/ 355/ 358	
Record of use		Record of use	
*****	Inspect gutters		

PERIODICAL EXAMINATION AND REPAIR HISTORY (EXAMPLE)

Date	Reason for entry (Type of examination/repair)	Defects noted or other comments (and repairs carried out, if any)	Name (in capital letters) and signature of competent person	Next due date for periodical examination
*****	Thorough examination. (PPE)	None	A.N. OTHER A N Other	*****

8. TRANSPORTATION

KEE WALK components are of robust construction. While care should be taken during transportation not to cause any damage to them, special packaging is not required.

9. MARKINGS ON THE PRODUCTS AND THEIR MEANING

Various markings can be found on KEE WALK components. Always check the legibility of the product markings. The meaning of these markings is as follows:

Marking	Meaning
A) PART No. WW1000040	Manufacturers Component Part Number
B) SERIAL No. C1703018	Manufacturers Serial Number.
C) CE0013-KEE WALK-EN 516-1-C	Conforms to EN516:2006
D) Kee Safety	Manufacturer
E) MADE IN ENGLAND	Manufacture in England
F) CE 16	CE Marked to Construction Products Regulation
G) MAINTENANCE ACCESS WALKWAY FOR LEVEL & INCLINED METAL PROFILE ROOFS	Description of Product
H) KEE SAFETY, UNIT A2, CRADLEY BUSINESS PARK, CRADLEY HEATH, WEST MIDLANDS	Address of Manufacturer

Walkway Tread: text highlighted in white for IFU use only.

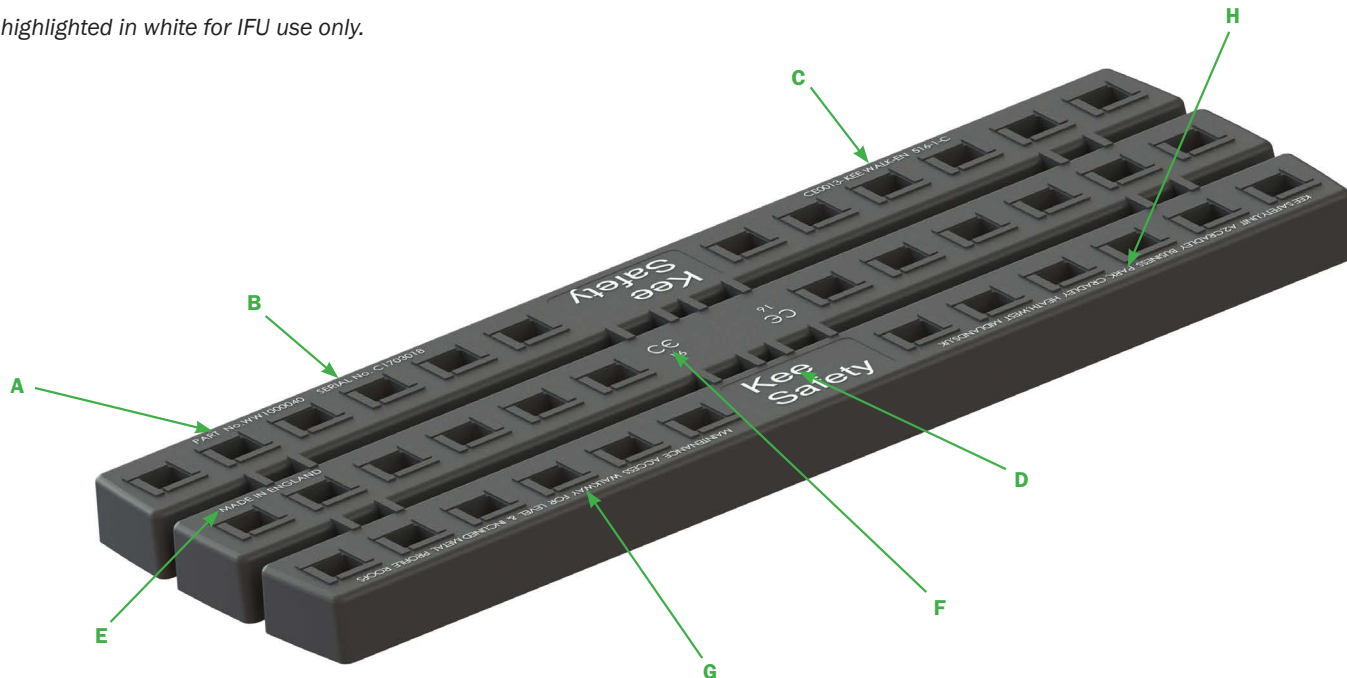

A plate pictured below should be attached to the walkway system at the beginning of each KEE WALK system.

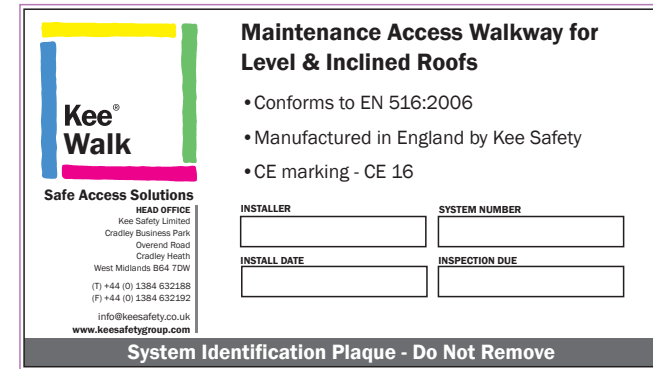

Identification Plate – WWIDPLA01

To be placed at the start and end of each system.

KEE WALK®

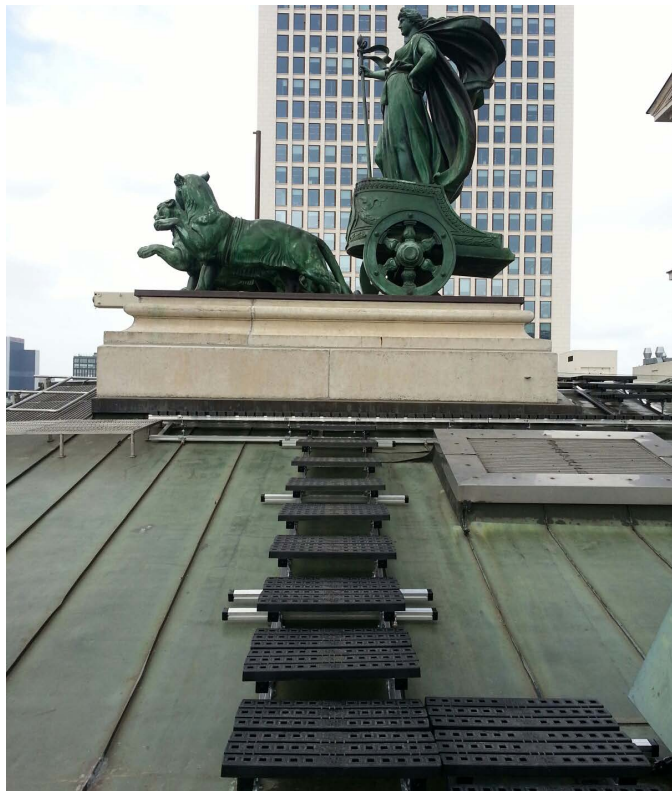

Kee Safety Shanghai

上海市黄浦区延安东路588号, 远
洋商业大厦一期16AB

16AB Sino-Ocean Tower, 588 Yan An
East Road Shanghai, China

Tel.: +86 400 820 9261

Email: chnsales@keesafety.com

Website: www.keesafety.cn

KEE WALK is a registered trademark of Kee Safety Ltd. Whilst every effort has been made to ensure the accuracy of the information contained within this brochure Kee Safety Ltd cannot be held responsible for any errors or omissions. Kee Safety Ltd reserves the right to alter or withdraw products without prior notice. Kee Safety Ltd accepts no responsibility for any loss or damage arising from improper use of their products. ©2018 Kee Safety Ltd. All Rights Reserved.