



SAFETY AT THE HIGHEST LEVEL

# KeeWalk Step Over Instructions for Use Manual



SECTION	CONTENTS	PAGE
1	Introduction	1
1.1	Validity	1
1.2	Authorised Agent	1
1.3	Compatibility	1
1.4	Health & Safety	1
1.5	Familiarisation	1
1.6	Anticipated Life	1
1.7	Safeguarding the Instruction For Use Manual	1
1.8	Copyright	1
1.9	Amendment Service	1
1.10	Modifications to The KeeWalk® Step Over System	1
1.11	Definition of Authorised Person	1
1.12	Definition of Trained Person	1
1.13	Use in Accordance with Regulations	1
1.14	Incorrect Use	2
1.15	Operators Duty of Care	2
1.16	Atmospheric Conditions	2
1.17	Contaminated Surfaces	2
2	Basic Safety Instructions	3
3	Checking the Step Over System's Components	4
4	Platforms for the Major Roof Types	7
5	Assembling the Step Over	9
6	Finished Step Over	14
7	Kee Walk Step Over System Recertification	15

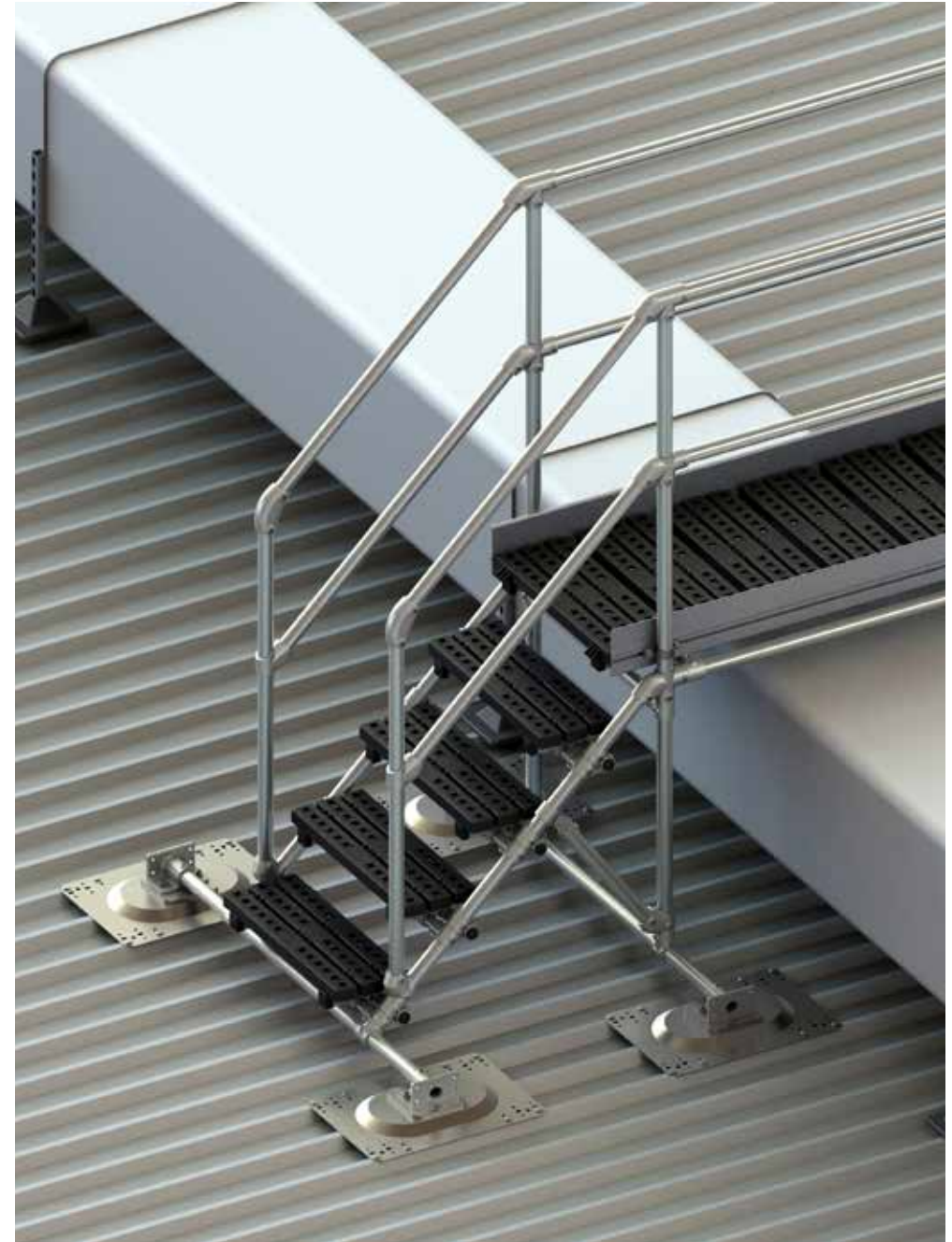

## 1. INTRODUCTION

### 1.1. Validity

These Instructions for Use apply to the following product:

Type: KeeWalk® Step Over System

Model Year: 2017

### 1.2 Authorised Agent

Kee Safety Limited Cradley Business Park Overend Road  
Cradley Heath B64 7DW

Tel: +44 (0) 1384 632188

E-Mail: sales@keesafety.com Internet: www.keesafety.co.uk

### 1.3 Compatibility

A KeeWalk® Step Over system is designed to provide a safe means of access up and over obstructions present in a designated walkway as part of a safe roof access system or as a standalone item used internally (i.e. warehousing) when access is required. Can be combined with KeeWalk, or as a standalone item when access or egress is required over an obstruction.

### 1.4 Health and Safety



Installers and users must comply with all relevant health and safety regulations in their given territory.

ADVICE

### 1.5 Familiarisation

Before installing a KeeWalk® Step Over for the first time, the installers are required to attend a Kee Safety Installation Course.

### 1.6 Anticipated Life

Metal Components: Up to 25 years in non-marine, non-corrosive (e.g. chemical plant) environments with a temperature range from -10 to + 55 degrees centigrade subject to use and a mandatory annual inspection strictly in accordance with these instructions.

Nylon/Plastic Components: Up to 25 years in non-marine, non-corrosive (e.g. chemical plant) environments but may degrade past this with prolonged UV exposure and subject to use and a mandatory annual inspection strictly in accordance with these instructions. Plastics are fire-rated to ISO 11357-1/3.

### 1.7 Safeguarding the Instruction Manual

This Instructions for Use document forms a component part of the KeeWalk Step Over® system. It must accompany the system and be followed for assembly. At no time must any pages be removed from these instructions. If the instructions are lost in their entirety or in part, the instructions or the missing parts must be replaced immediately.

### 1.8 Copyright

This documentation contains information protected by copyright. It may not be photocopied, reproduced, translated or recorded on data media, either completely or as extracts, without prior permission. We reserve all further rights.

### 1.9 Amendment Service

This document is not subject to any amendment service from the manufacturer. Amendments to this documentation can be carried out without prior notice.

### 1.10 Modifications to The KeeWalk® Step Over System

If you undertake modifications to the KeeWalk® Step Over system, you will negate all certification that comes with this product.

### 1.11 Definition “Authorised Person”

A person is deemed to be an authorised person if they have been authorised to work on or with the KeeWalk® Step Over System in accordance with these instructions.

### 1.12 Definition “Trained Person”

Trained persons, are persons who, based on their specialist training and experience have adequate knowledge of the system to be checked and are sufficiently familiar with the relevant regulations, guidelines and generally recognised rules of the KeeWalk® Step Over system and accompanying regulations - e.g., Health and Safety Regulations and Accident Prevention Regulations that are in force in the country of use; and can assess the safe working conditions of the installation location. A trained person shall be responsible for selecting all users of The KeeWalk® Step Over system.

### 1.13 Use in Accordance with Regulations

The Step Over system provides both a demarcation route for flat roofs which are not accessible to the public but to which access is required for the purpose of carrying out repairs and maintenance alongside use within a warehousing or internal application where access up and over plant or equipment is required in order to provide safe passage from point to point.

The Step Over system is designed as a permanently installed system. However, dismantling and reconstruction at a different location is permissible under certain circumstances.

*The Step Over system is only regarded as being used for its intended use if all the following conditions are met:*

*The Step Over system is governed by various workplace Regulations and Guidelines. Operating personnel must be familiar with the statutory requirements arising from these. They must also be familiar with and adhere to the following specifications and technical regulations:*

- HSG-33, Health & Safety in Roof work, HSE INDG 284- Working on Flat Roofs BS EN 516 : 2006
- The total weight of the Step Over system depends on the length and configuration of the whole system..
- The load-bearing capacity of the roof, flooring or area in which the Step Over Platform system is to be installed must at least correspond to the total weight of the system plus potential personnel. If in doubt, you must arrange for the substrate to which you are fixing to be examined by a structural engineer before assembly.
- The Step Over system must be linked to the building’s lightning protection system if possible, or earth bonded if used internally.
- The Step Over system is only designed for use on those specified in the assembly instructions.

- When operating the system externally care is necessary when the wind speed is in the region of 17m.p.h. (gusting to 26 m.p.h. or over).
- All operations being carried out in the vicinity of the Walkway system should cease when the average (mean) wind speed reaches 23 m.p.h. (gusting to 35 m.p.h. or over).
- The installed surface must be free from algae, stones, oil, grease, water accumulation and loose debris.

## 1.14 Incorrect Use

The following points are classed as misuse:

- Use of the Walkway system if one of the conditions specified under “intended use” is not met.
- Failure to observe the weights and conditions relating to the substrate specified under “intended use”. If the conditions specified are not adhered to, then the Walkway system may possibly fail.
- Use of a damaged Walkway system or one which has been assembled incorrectly or is incomplete.
- Should the Walkway system be used in spite of these instructions, then the possibility of a fall occurring and severe or fatal injury is possible.

**Use of The KeeWalk® Step Over system in any of the above conditions is forbidden**

## 1.15 Operator’s Duty of Care

The duties and obligations of the operator and trained personnel when dealing with The KeeWalk® Step Over system are set out below.

### a) Safety of The KeeWalk® Step Over system

In particular, the owner or employer must ensure that the Walkway system is:

- Only used as intended.
- Is only provided in a fault-free reliable state.
- Is checked regularly.

### b) Instruction and Training

All users of the system must ensure that:

- Before using the system for the first time and at least once annually thereafter, all personnel shall be instructed in all relevant matters of health and safety at work (with particular emphasis on Working at Height) and environmental protection.
- The instructions for use are always available in a legible state, are complete and are kept with the system at all times.
- All users are familiar with the contents of these instructions.

### c) Duties of the User

The user must fulfil the following duties:

- Assemble The KeeWalk® Step Over system strictly in accordance with this Instructions for Use Manual and check that the system is functioning correctly and safely.
- Recognise any defects and withdraw the system from use and alert the manufacturer so an assessment and required repairs can be completed.

### d) Requirements of the User

In order to be able to fulfil his or her duties, the user must meet the following requirements:

- They must have adequate knowledge of the English language to understand these Instructions for Use.

*It is unlikely that any medical condition may directly affect (or be affected by) the use of this product in itself, but users must be aware that:*

- Working at height or within a busy warehousing or industrial setting is a dangerous occupation.
- They should be trained to do so, and should comply with any medical requirements set by the training provider.

## 1.16 Atmospheric Conditions CARE TO BE EXERCISED!

 **When the Step Over system is installed externally it should be used with care during periods when there is frost, ice or snow in the vicinity, or if these conditions are imminent.**

## 1.17 Contaminated Surfaces DANGER TO LIFE!

 **Do not use the KeeWalk Step Over system if oil, grease or other lubricant, or growth of algae contaminates any part of the system.**





# For Your Safety

## 2. BASIC SAFETY INSTRUCTIONS

Basic safety instructions for the safe handling of the KeeWalk® Step Over system can be found here.

### DANGER TO LIFE!

It is imperative that you follow these safety instructions to avoid endangering your life and safety.



Possible Danger	Prevention Measures
<p><b>DANGER TO LIFE!</b> There is a risk of the construction personnel falling during assembly or when carrying out repairs. <b>Explanation:</b> Inadequate or insufficient safety measures or errors during the assembly of the Step Over system can lead to falls resulting in severe/fatal injuries.</p>	<ul style="list-style-type: none"> <li>• The Step Over system is only to be assembled as specified in the assembly instructions.</li> <li>• After assembly or after carrying out repairs, check all structural parts and connecting components to make sure that they are located correctly.</li> <li>• Do not install the platform on any surfaces, either internal or external, that are damaged.</li> </ul>
<p><b>DANGER TO LIFE!</b> There is a risk of the Step Over system failing if the installation site is unsatisfactory. <b>Explanation:</b> A non-approved roof surface can result in The Walkway system sliding and failing.</p>	<ul style="list-style-type: none"> <li>• Follow the detailed information on the installation sites for the Step Over system in the assembly instructions.</li> <li>• The roof surface must always be of the prescribed quality and load-bearing capacity.</li> <li>• The prescribed measures must always be complied with.</li> </ul>
<p><b>DANGER TO LIFE!</b> There is a risk of people falling due to failure to carry out maintenance work on the Step Over System. <b>Explanation:</b> Defects or damage can impair the function of the Walkway system therefore the system may possibly not be guaranteed in the event of an emergency.</p>	<ul style="list-style-type: none"> <li>• If you have to carry out repairs on the roof or any plant always carry out a visual check on the Step Over system and the roof area beforehand for damage.</li> <li>• Any parts that are found to be damaged. must always be replaced before any work is started. Only then is it permitted to start the actual work on the roof.</li> </ul>
<p><b>DANGER TO LIFE!</b> There is a risk of people falling due to attaching Personal Protection Equipment to a Step Over system. <b>Explanation:</b> The Walkway system must never be used to attach P.P.E. to as an anchor for abseiling or similar work.</p>	<ul style="list-style-type: none"> <li>• The Step Over system is a stand alone, maintenance Walkway system and should always be treated as such. Under no circumstances should the system be used as a "man anchor" or as a connection for P.P.E.</li> </ul>



# Checking the Step Over System's Components

### 3. Designation and function of the components for standard systems

The Step Over system consists of the following pre-assembled modules & individual components. The exact number of individual components depends on the length and construction of the step over system. All fittings are cast from malleable cast iron to BS EN 1562 and galvanised to BS EN ISO 1461 and full part numbers for reference are detailed below. Aluminium toeboard is 6062-T6 grade.

*Note: A complete list of all parts and details on the total weight of the Step Over system is provided with the delivery. The load-bearing capacity of the roof must be equal to or exceed the capacity specified.*

 <p><b>10-7</b></p>	 <p><b>10-76</b></p>	 <p><b>29-7</b></p>	 <p><b>55-7</b></p>	 <p><b>C50-77</b></p>
 <p><b>325-7</b></p>	 <p><b>326-7</b></p>	 <p><b>45-7</b></p>	 <p><b>74-7</b></p>	 <p><b>199-B</b></p>
 <p><b>62-7</b></p>	 <p><b>63-7</b></p>	 <p><b>69-7</b></p>	 <p><b>77-7</b></p>	 <p><b>105-7</b></p>
 <p><b>440-7</b></p>	 <p><b>KGTF1</b></p>	 <p><b>TB3-7</b></p>	 <p><b>TB150</b></p>	 <p><b>TRSTEPASSY</b></p>

# Checking the Step Over System's Components

**A**



**Weighted foot assembly**

**B**



**Front guardrail upright**

**C**



**Step module guardrails**

**D**



**Bridge module guardrails**

**E**



**Toe board assembly**

**H**



**Stair tread assembly**

**F**



**Bridge module**

**G**



**Back upright assembly**

# Checking the Step Over System's Components

Exploded view of system layout and location of components and sub-assemblies:

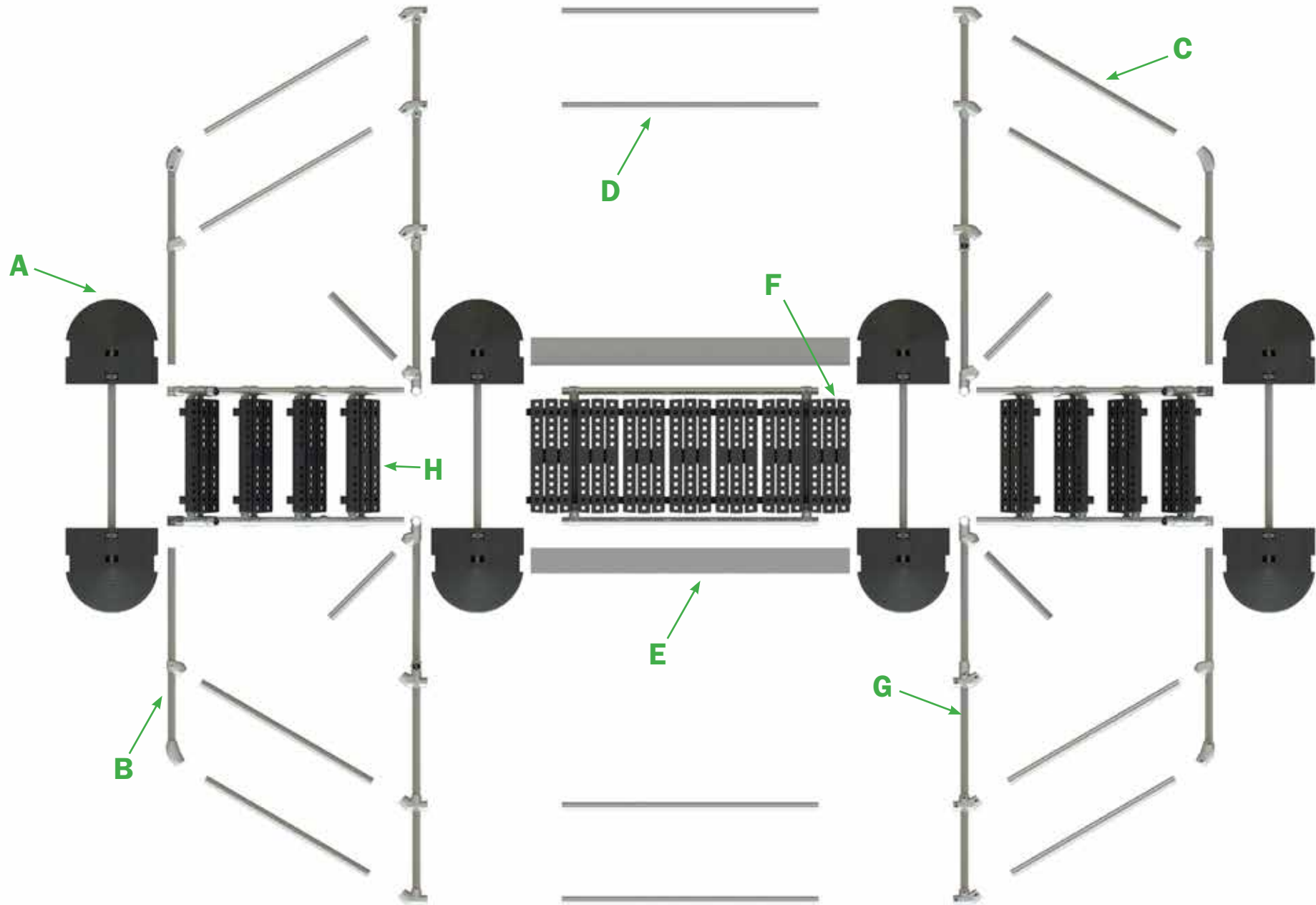



# Platforms for the Major Roof Types

## 4. The Kee Safety Step Over modules are available to suit all major roof types

The Step Over range consists of a number of different configurations to suit the major flat roof types. Membrane and concrete roof type platforms are standard units whereas metal profile roofs are bespoke to the particular application requiring a survey and semi-bespoke base plate layout design. This will ensure a perfect fit and other height/width/length variables can be accommodated as a bespoke solution - contact Kee Safety for further information.

### Step Overs for membrane/Asphalt/PVC roofs



Step over shown with 440 base feet for membrane/asphalt/PVC roofs.

Roof Type	Obstacle Height (mm)	Obstacle Width (mm)	Foot Type	Part Number
Membrane/Asphalt/PVC	600	1000	440-7	STMB600
Membrane/Asphalt/PVC	800	1000	440-7	STMB800
Membrane/Asphalt/PVC	1000	1000	440-7	STMB1000
Membrane/Asphalt/PVC	1200	1000	440-7	STMB1200
Membrane/Asphalt/PVC	1400	1000	440-7	STMB1400

# Platforms for the Major Roof Types

**The Kee Safety Step Over modules are available to suit all major roof types**

The Step Over range consists of a number of different configurations to suit the major flat roof types. Membrane and concrete roof type platforms are standard units whereas metal profile roofs are bespoke to the particular application requiring a survey and semi-bespoke base plate layout design. This will ensure a perfect fit and other height/width/length variables can be accommodated as a bespoke solution - contact Kee Safety for further information. Where access is limited on a roof, or within a warehouse environment, we can offer the below solution.

**Concrete floors/restricted access roofs\***



Roof Type	Obstacle Height (mm)	Obstacle Width (mm)	Foot Type	Part Number
Concrete	600	1000	62-7/63-7	STCR600
Concrete	800	1000	62-7/63-7	STCR800
Concrete	1000	1000	62-7/63-7	STCR1000
Concrete	1200	1000	62-7/63-7	STCR1200
Concrete	1400	1000	62-7/63-7	STCR1400

\*Concrete slab and elastomeric pad to be used on membrane/asphalt/PVC roofs to spread the imposed load from the platform.

**5. Installation should only be carried out once the design has been verified in the Step Over Configurator and the installer has been fully trained by Kee Safety.**

**Tool list:**

- Ratchet
- Hex Key Socket Screw sized 5/16"AF
- Torque wrench 10-60Nm
- Electric/battery drill
- Electric/battery impact driver
- Selection of drill bits – including 8.5mm diameter bit
- Tape Measure
- Line and level
- Full metric socket set
- Full set metric spanners
- Full set of metric Allen keys
- Full set of imperial Allen keys
- Copper/Rubber mallet
- Rags and cleaning fluid

**STEP 1**

**Assembling back leg upright with weights and cross rail**

Take both back upright assemblies (Part G) to the position of the obstacle, along with the weighted foot assemblies (Part A).

Starting with the left-hand side back upright assembly, up end the upright such that it is orientated with the 10-7 fitting at the bottom. Pick up the weight cross rail, and feed through into the lower fitting of the upright, and slide the right-hand side towards the left.

Insert the cross rail at mid-point to connect both uprights together.

Insert the 74-7 fittings into the 440-7 weights and add the weights to either end of the tube, ensuring the weights are inserted fully. Tighten the 74-7 grubscrews to 39Nm.

Manoeuvre the assembled rear upright into position at the point of install.

Tighten all grubscrews to the required 39Nm torque setting.





# Assembling the Step Over

## STEP 2 - Repeat Step 1 for other side of stair case

Repeating of step 1 enables the other side of the uprights to be built, which in turn allows the next phase of the build to commence.

### Repeating all sub sets of step 1 to build other side of platform uprights



## STEP 3 - Assemble bridge module and guardrail onto rear leg uprights

Take the bridge platform subassembly (Part F) framework and insert into the 326 fitting present on one side of the rear uprights, followed by the handrails (Part B) into the fittings further up the upright.

Bring the opposite outer leg assembly to meet the platform, and locate tubes from bridge module subframe into the slope fittings present on the uprights.

Add the Kee Walk bridge tread assembly to the substrate, ensuring it is centered left/right and front/back and fix into place using the 105-7 fittings to the underside and securing in place with self-drilling screw.

## Inserting bridge subframe tubes into uprights at obstruction

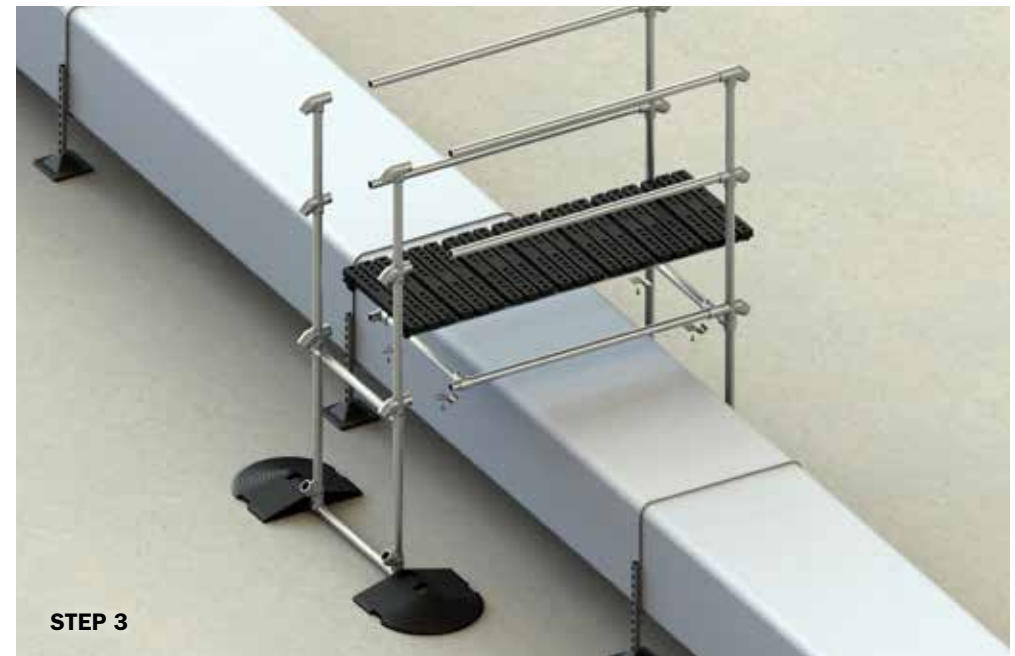

## Inserting bridge subframe tubes into uprights at obstruction and securing walkway





# Assembling the Step Over

## STEP 4 - Stair Case assembly

Take the stair tread assembly module (Part H) to the area in which it is to be installed, and collect the 440 weights, cross tubes and relevant fittings (Part A).

Insert the lower weight cross tube into the lower 10-7 fittings sliding from left to right; space the tube such that an equal overhang exists both sides. And tighten grub screws on 10-7's to 39Nm.

Locate cross brace tube into C50-77 fitting and tighten.

Take the pre-assembled stair module and move towards assembled bridge platform in previous steps.



STEP 4

## STEP 5 - Stair Case assembly

Locate upper tube from staircase and brace tube in the correct orientation to meet the corresponding tube sockets in the lower 29-7 and upper 326-7 Fitting.

Starting with the upper tube, manoeuvre the lower tube down towards the stair assembly and lower the staircase such that the upper tube can be inserted into the 326-7 fitting. Before fitting fully, located lower tube into 29-7 fitting.

Push both tubes on both sides home, ensuring staircase is square. Lightly tighten grub screws to locate stair assembly into place.

Insert the 74-7 fitting into the weights and slide the weights onto the end of the tube ensuring that they are fully inserted.

Double check for location, once happy tighten all grub screws to 39Nm. Repeat the procedure for the other staircase.

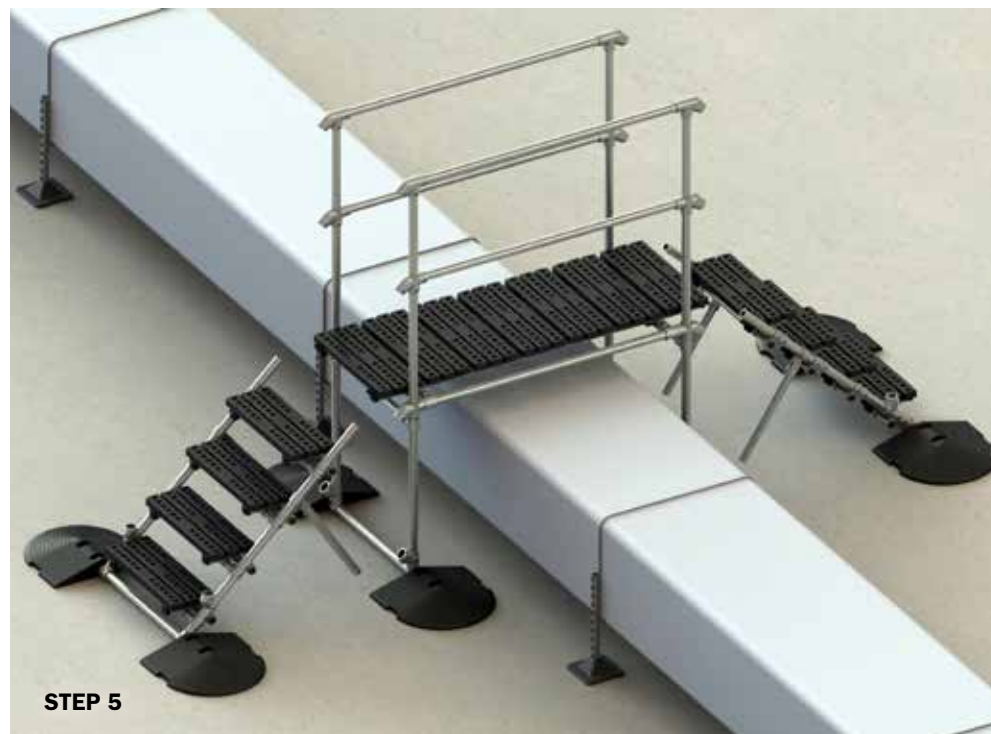

STEP 5

# Assembling the Step Over

## STEP 6 - Assemble the remaining handrails and toeboard

Take the forward assembled uprights (Part B) and insert into the 29-7 fitting present on the stair assembly and loosely tighten the fittings.

Starting on one side, insert the two inclined hand rails (Part C) into the 326-7 fittings present on the rear upright, and manoeuvring the front upright forward insert both rails in the 29-7 and the 55-7 fittings, move the upright back to its upright position and loosely tighten.

Using a spirit level, ensure the forward upright is plumb and level in the X and Y plane, once level, tighten all grub screws to 39Nm.

Repeat for other side of staircase, and then repeat the entire procedure for the other staircase.

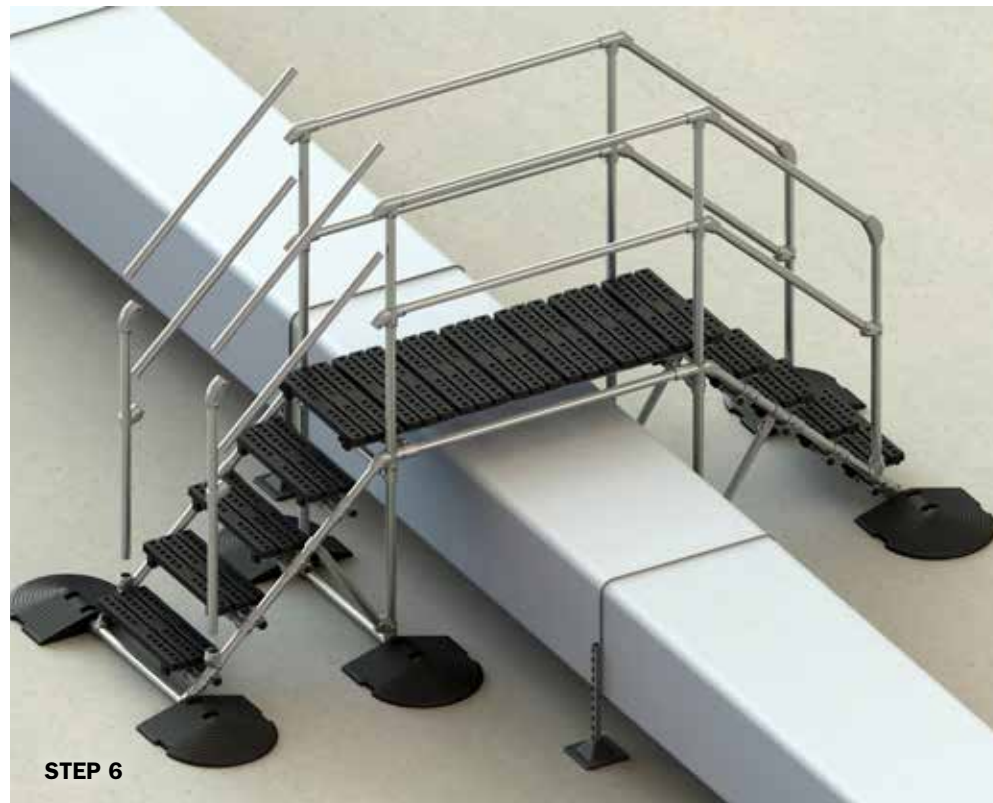

## STEP 7 - Fitting toe board.

Locate toe board (Part E) inboard of bridge platform and pick the TBFP1 fixing packs and TB3-7 toe-board fixing clamps.

Insert the M12 bolts into the extruded channel, and locate 1 bolt either side of each upright as shown in the illustration.

Locate the TB3 clip onto the bolts, fits the nuts and washers.

Level the toe board and tighten the fixings to 25Nm.



# Assembling the Step Over

## STEP 8 - Leveling and finalising of treads

With the platform now fully assembled, check the tread rise (distance in height between treads), going (where the tread sits in plan), and angle.

Starting at the bottom tread, measure the rise between the treads ensuring that there is no more than 5% difference between any two tread heights\*.

Looking from above, there should be a minimum of 10mm overlap on the treads\*.

Starting at the top tread, and using a spirit level, ensure that all treads are level left/right and forwards/backwards. If an adjustment needs to be made in the fore/aft level simply slacken the grub screws on the 45-76 and 10-76 on both sides, adjust tread to correct, level angle and re-tighten.

If adjustment needs to be made to accommodate the 10mm overlap between treads, simply undo the 13mm nuts holding the tread extrusion to the 199-6 fitting and adjust, ensuring that they are re-tightened on completion.

(\* = The Stair rail and tread assemblies are pre-assembled at Kee Safety so no major adjustments should be required)



## STEP 9 - Check and recheck all grub screws and finalise assembly

Once all treads are level, the platform is fully assembled, and the toeboard is present **ALL** grub screws are to be torqued to 39Nm

Starting at the lower left staircase, working from the lowest point, systematically tighten all grub screws with a calibrated torque wrench and indelibly mark the grub screw with a paintmarker once at torque.

This performs two functions, it lets the installer know once a grub screw has been tightened, but also on annual inspection allows the inspector to see if a grub screw has come loose and needs attention.

The same principle is applied to all other fixings, using 18Nm for all 13mm headed fixings, 25Nm on toeboard M12 fixings and Tek Screws to be tightened until a compressing of the Foam backed washer is observed.

**It is IMPERATIVE that ALL grub screws and fixings are checked on the ENTIRE assembly and torqued upto the correct torque value and marked!!**





# Finished Step Over

6. Step over assembled with 440-7 feet for membrane/asphalt/PVC roofs



Step over assembled with 62-7/63-7 feet for concrete roofs



Step over assembled with Top Fix baseplates for metal profile roofs



## METAL PROFILE ROOF APPLICATION

Whilst we can supply step over platforms for membrane/asphalt/PVC and concrete from stock, owing to the vast variety of roofing profiles and fixing methods it is not possible to carry stocks of step over platforms specific to each roofing type and manufacturer.

A bespoke solution is available following a site survey to best advise on the product that is most suited to the requirement, contact Kee Safety for more information.



## 7. KEE WALK STEP OVER SYSTEM RECERTIFICATION

- Periodic inspections by a competent person are recommended by the manufacturer. In UK/Europe these are required under Regulation 5 of the Workplace (Health, Safety & Welfare) Regulations, the Work at Height Regulations and BS EN 365. The frequency will depend upon the environment, location and usage but should be at least every 12 months.
- Walk and visually inspect the complete installed system in relation to the clients general needs. Establish if any modifications and/or additional products are required to reflect any refurbishment requirements or additional plant & equipment which have been installed and require access.
- Check installation configuration is complete as per the original installation drawing/plan.
- Ensure the system has not been modified or tampered with by unauthorised persons.
- Check all base feet are in contact with the roof.
- Check all counter weights (where present on original drawing) are in place as per the original drawing. This is essential for longevity of the roof.
- Check all grub screws are in place and correctly torqued.
- Check the general height and level of the system including the leg centres and platform overall configuration.  
(This only tends to be an issue if the system has been tampered with between inspections).
- Any galvanised components showing signs of corrosion should be wire brushed thoroughly and galvanised spray/paint applied as appropriate. If rusted significantly, take digital photographs and include these in the inspection report.
- Where toe-boards are fitted check the brackets that support the toe-board are in place and sufficiently torqued.
- Where applicable check fixings to walls/structures including cat ladder clamps are in place and sufficiently torqued.

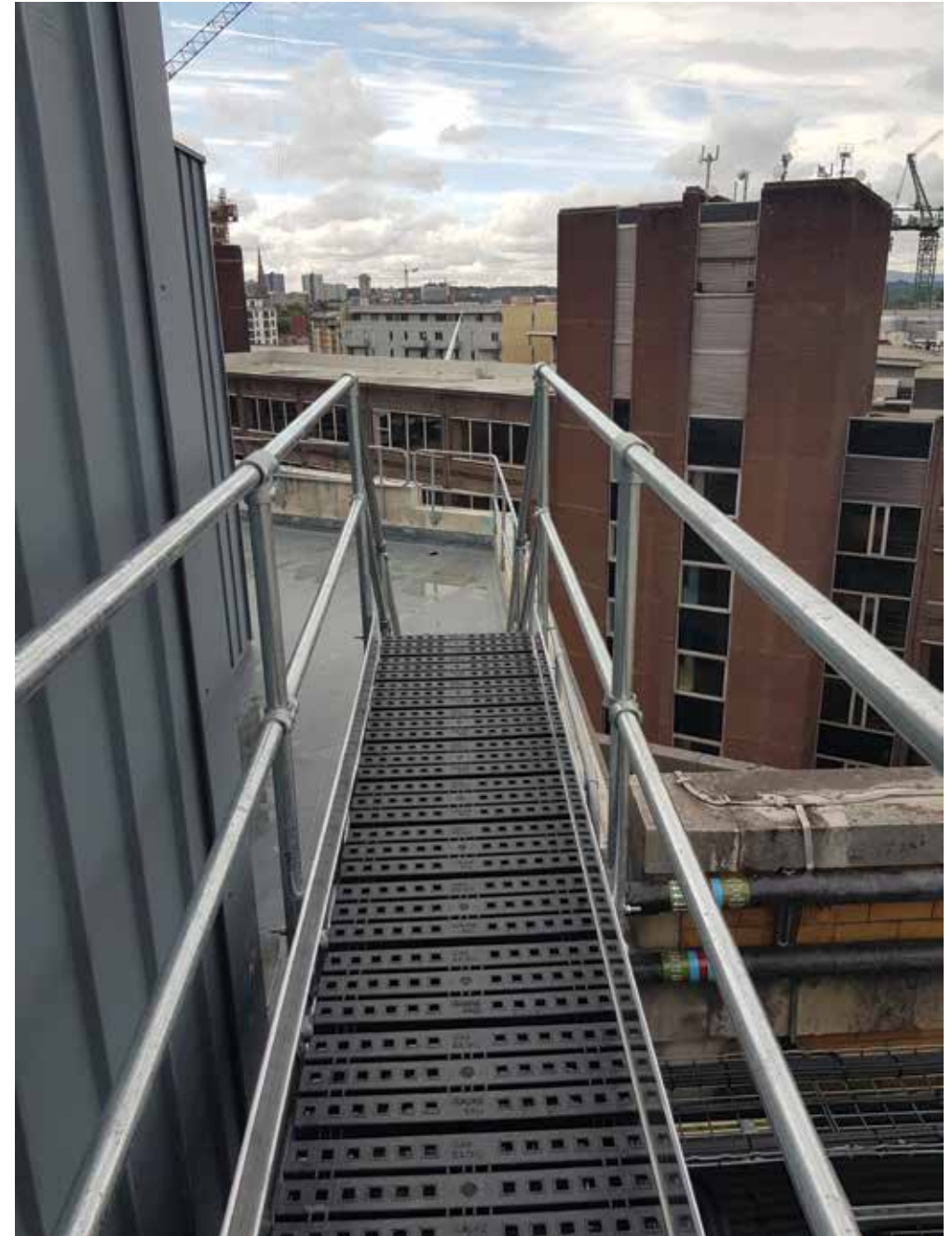

# KeeWalk® Step Over



## Kee Safety Shanghai

上海市黄浦区延安东路588号，远洋商业大厦一期16AB

16AB Sino-Ocean Tower, 588 Yan An East Road Shanghai, China

Tel.: +86 400 820 9261

Email: [chnsales@keesafety.com](mailto:chnsales@keesafety.com)

Website: [www.keesafety.cn](http://www.keesafety.cn)

KEEWALK is a registered trademark of Kee Safety Ltd. Whilst every effort has been made to ensure the accuracy of the information contained within this brochure Kee Safety Ltd cannot be held responsible for any errors or omissions. Kee Safety Ltd reserves the right to alter or withdraw products without prior notice. Kee Safety Ltd accepts no responsibility for any loss or damage arising from improper use of their products. ©2016 Kee Safety Ltd. All Rights Reserved.