



keesafety.co.uk

Distribution

# Product Catalogue

2022



SEPARATING PEOPLE FROM HAZARDS



## Separating people from hazards... this is the simple philosophy that drives Kee Safety.

As a leading global supplier of fall protection systems, guardrails and working at height safety equipment, our business has substantially expanded since our inception in the UK some 80 years ago, with the launch of our very first KEE KLAMP fittings range.

Kee Safety distributors and stockists have access to a wide range of our safety products, including components for safety barriers, fall protection and safe access systems, and CE certified steelwork fixings.

Our dedicated sales and technical teams have worked within the construction industry for many years. Together with their expert industry knowledge and our safety product ranges, Kee Safety is fully capable of providing you with safety solutions that will service your clients' needs.

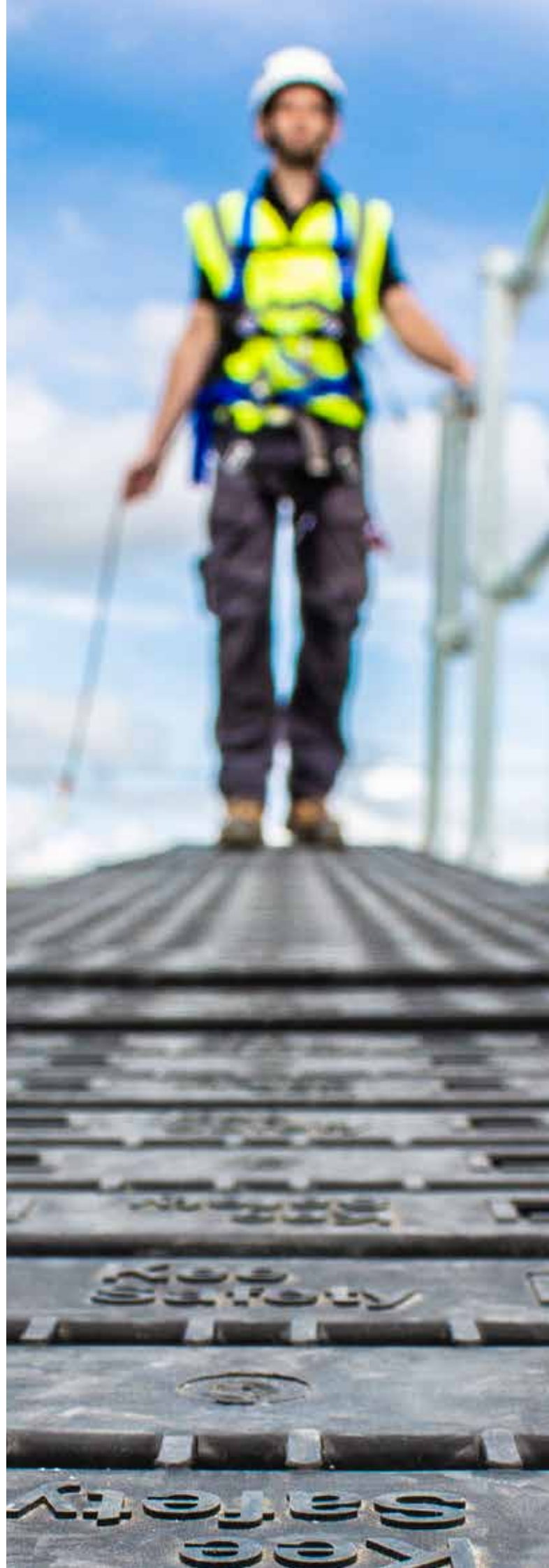

# Contents

Safety Solutions for Workplace Hazards	4-5
Safety Solutions for Working at Height	6-7
<b>KEE KLAMP</b> Safety Barrier Solutions	8-11
<b>KEE LITE</b> Aluminium Barrier Solutions	12-14
Safety Loading Standards	15
<b>KEE ACCESS</b> Handrails for People with Disability	16-17
<b>KWIK KIT</b> Warehouse Barriers	18-19
<b>KEE GATE</b> Self Closing Safety Gates	20-21
<b>KEE GATE</b> Pallet Gates	22-23
<b>KEE WALK</b> Safe Access Platforms	24-25
<b>KEE WALK</b> With Guardrail	26-27
<b>KEEGUARD</b> Free Standing Edge Protection	28-31
<b>KEEGUARD LITE</b> Aluminium Roof Edge Protection	32-33
<b>KEEGUARD PREMIUM</b> Portable Roof Edge Protection	34-35
<b>KEEGUARD TOPFIX</b> Edge Protection for Cladded Roofs	36-37
<b>KEEGUARD FOLDSHIELD</b> Folding Free-standing Edge Protection	38-39
<b>KEEGUARD LADDER KIT</b> Guardrail Kit for Roof Top Ladders	40-41
<b>KEE DOME</b> Skylight Fall Protection	42-43
<b>KEE COVER</b> Rooflight Protection	44-45
<b>KEE ANCHOR</b> Portable Deadweight Anchor	46-47
<b>KEE SIGN</b> Safety Signs Range	48-49
<b>KEE MARK</b> Free-standing Demarcation	50-51
<b>BOXBOLT</b> Blind Cavity Fixing	52-54
Help Desk	55

**Kee® Gate**



Page 22-23

**Kee® Klamp**

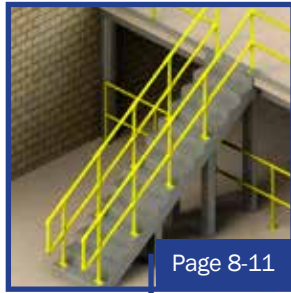

Page 8-11

**Kwik Kit®**



Page 18-19



Page 48-49

**Kee® Sign**



Page 8-11

**Kee® Klamp**



Page 24-25

**Kee® Walk**

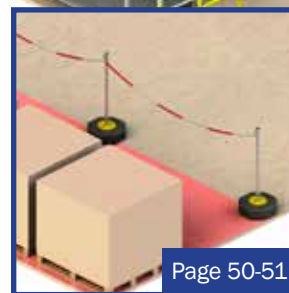

Page 50-51

**Kee® Mark**



# Safety Solutions for Workplace Hazards

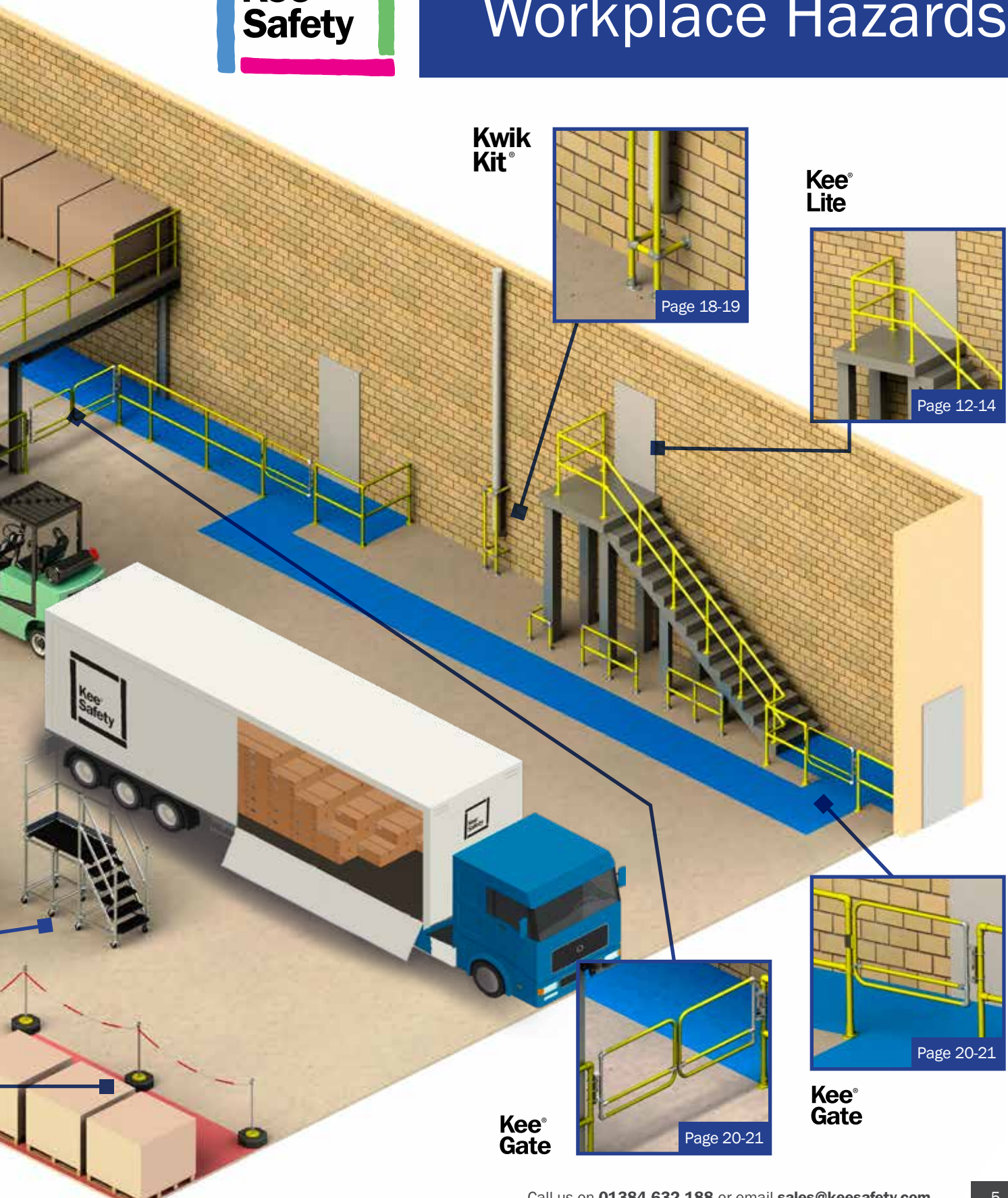

**Kwik Kit<sup>®</sup>**



Page 18-19

**Kee Lite<sup>®</sup>**

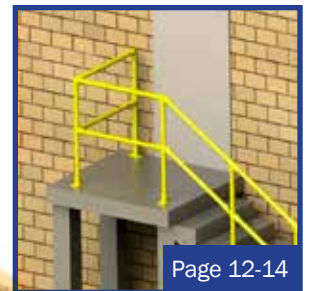

Page 12-14

**Kee Gate<sup>®</sup>**

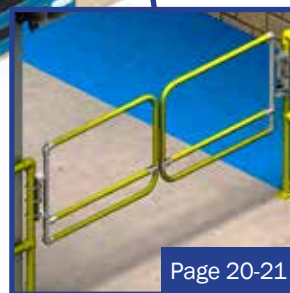

Page 20-21

**Kee Gate<sup>®</sup>**

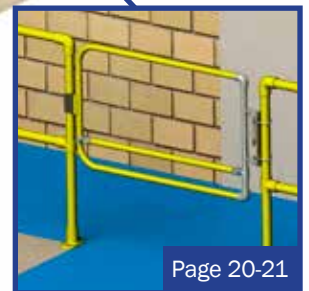

Page 20-21

**KeeGuard<sup>®</sup>  
Topfix**



**Kee<sup>®</sup>  
Walk**



**Kee<sup>®</sup>  
Gate**



**Kee<sup>®</sup>  
Cover**

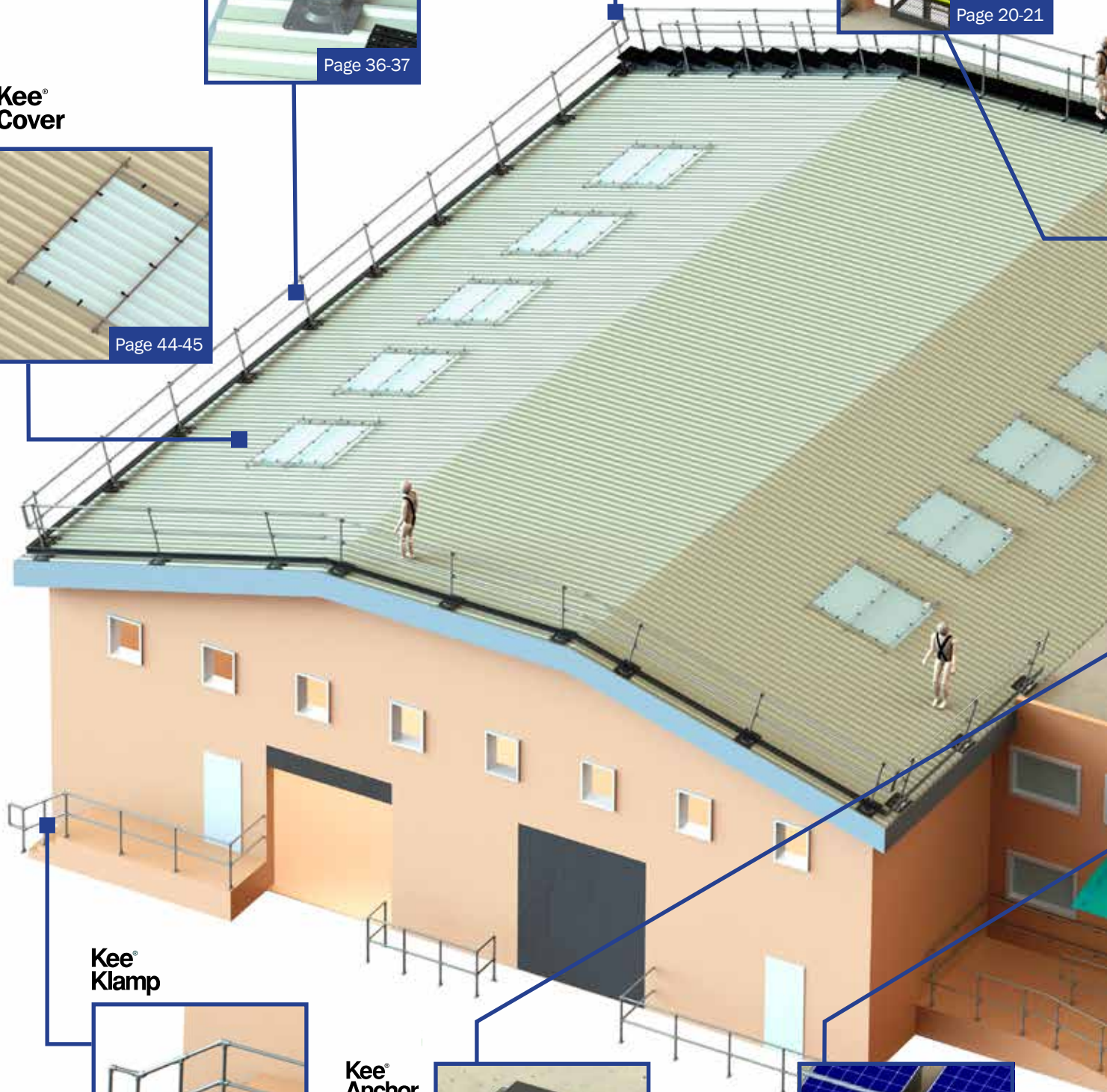
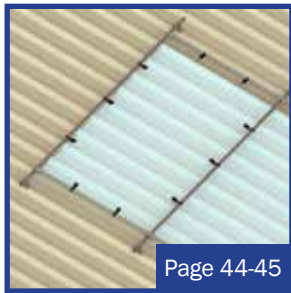

**Kee<sup>®</sup>  
Klump**



**Kee<sup>®</sup>  
Anchor**



**KeeGuard<sup>®</sup>  
Premium**

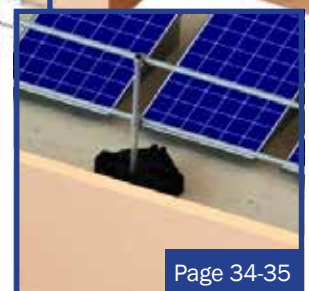



# Safety Solutions for Working at Height

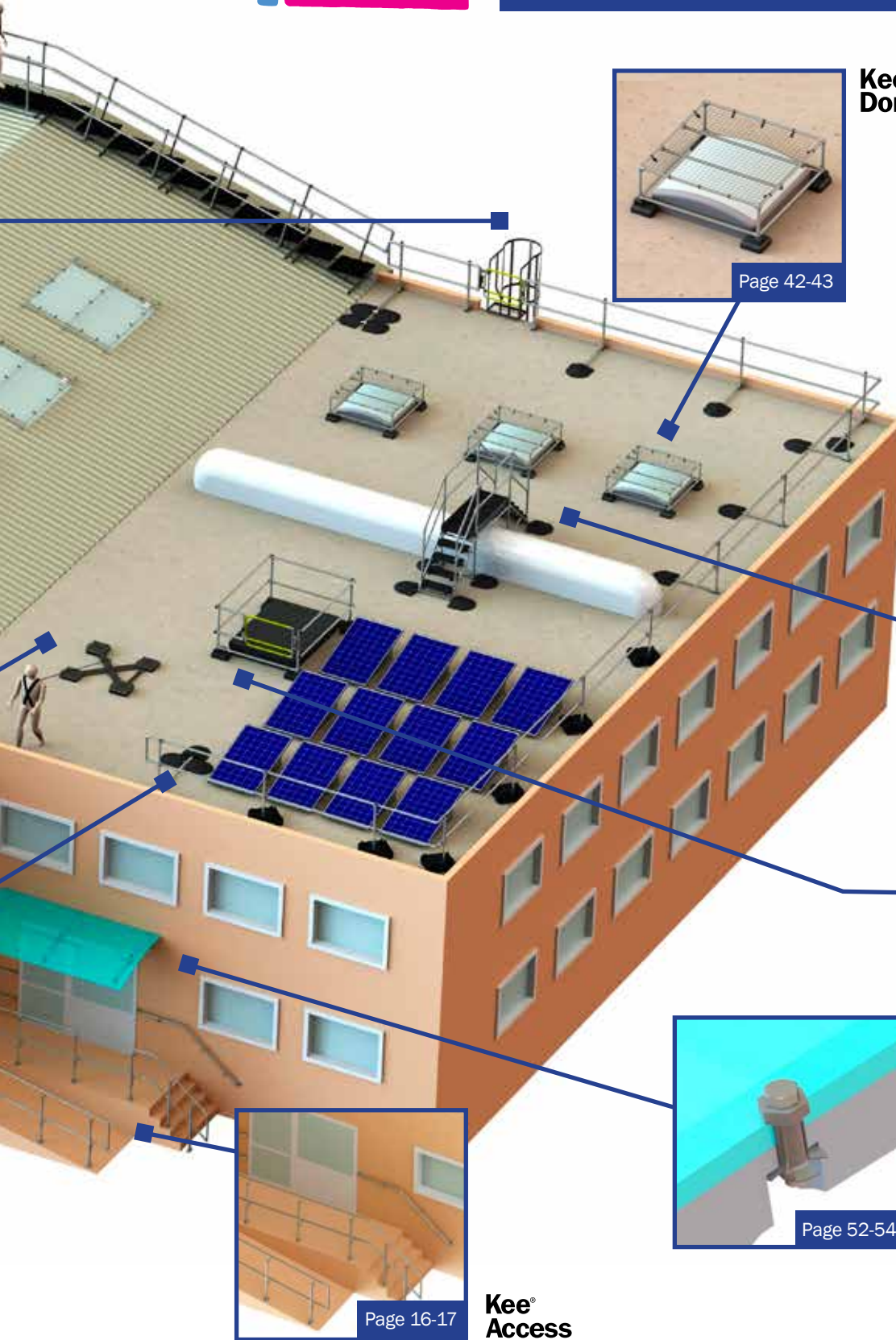

Page 42-43

**Kee®  
Dome**



Page 28-31

**Kee®  
Guard**



Page 24-25

**Kee®  
Walk**



Page 46-47

**Kee®  
Dome**

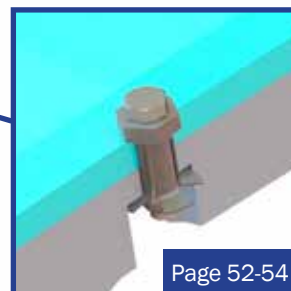

Page 52-54



Page 16-17

**Kee®  
Access**



**Kee®  
Klamp**



**3**

O/D 17.5mm  
N/B 10mm

**4**

O/D 21.3mm  
N/B 15mm

**5**

O/D 26.9mm  
N/B 20mm

**6**

O/D 33.7mm  
N/B 25mm

**7**

O/D 42.4mm  
N/B 32mm

**8**

O/D 48.3mm  
N/B 40mm

**9**

O/D 60.3mm  
N/B 50mm

KEE KLAMP Fitting Size	Tube Diameter Ø mm O/D
3	17.5
4	21.3
5	26.9
6	33.7
7	42.4
8	48.3
9	60.3



The **MOST FLEXIBLE SOLUTION** for the construction of safety railing, handrail, guardrail and barriers

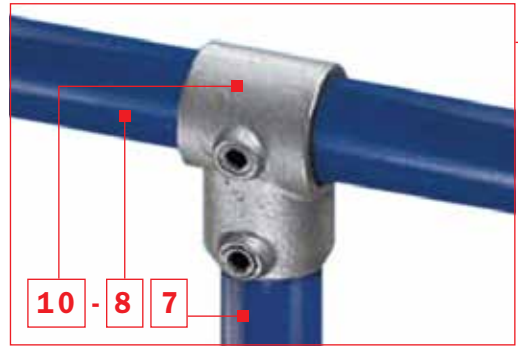

**10 - 8 7**



# Safety Barrier Solutions

## Key Features

KEE KLAMP components offer the most flexible solution for the construction of safety railing, handrail, guardrail and barriers. The KEE KLAMP range comprises a comprehensive selection of simple to use, galvanised malleable cast iron fittings. These fittings allow pre-cut lengths of standard tubing to be connected together to form safety guardrails and other types of tubular framework structure.

All fittings within the KEE KLAMP range incorporate an integral socket screw which locks the fitting securely onto its tube to give an excellent slip load performance. The extensive range ensures that they can also cope easily with any changes in direction or gradient, and easily accommodate requirements for adapting or extending an existing structure.

KEE KLAMP railing systems offer a strong and durable solution to separate people from hazards; they are more resistant to corrosion and can last much longer than fabricated barriers and handrails. They also eliminate the need for welding, cutting, threading or bolting and remove the need for skilled labour and permits for work. The main KEE KLAMP fittings are TÜV certified for strength, manufacturing quality and consistency.

KEE SAFETY barrier systems meet every safety loading standard, please refer to the Safety Loading Standards chart on page 15 for more information.

## Technical Information

KEE KLAMP components are available in seven sizes to suit different tube diameters. The fittings are iron castings manufactured to the requirements of EN 1562 & 1563. A KEE KLAMP component (sizes 5 to 9) can support an axial load of 900Kg per set screw with the set screw tightened to a torque of 4Kgm (39Nm or 29lbs ft); rating includes a safety factor of 2:1. This is normally obtained when the set screw is fully tightened using a ratchet wrench.

## Specifying KEE KLAMP Components

Each fitting has a simple numerical code reference, which defines the type of fitting and the pipe size, or sizes, it is designed to receive. The first number, preceding the dash (-) identifies the type of KEE KLAMP fitting. A single digit, following the dash, defines tube size. Two single digits after the dash indicate that the fitting is designed to receive two sizes of tube.

## Features & Benefits

- Widest range of tubular fittings available on the market
- Use standard tube
- No welding, so no hot work permits required
- Quick installation / Cost-effective
- Flexible systems allow on-site alterations
- Can be used in all types of market sectors

### Single Socket Tee

**10**

Type  
10-3 10-75  
10-4 10-76  
10-5 10-78  
10-6 10-8  
10-65 10-87  
10-67 10-9  
10-7 10-98



### Split Single Socket Tee

**A10**

Type  
A10-7  
A10-8



### Single Socket Tee

**12**

45°  
Type  
12-5  
12-6  
12-7  
12-8



### Split Single Socket Tee

**A12**

45°  
Type  
A12-8



### Straight Coupling

**14**

Type  
14-4  
14-5  
14-6  
14-7  
14-8  
14-9



### Elbow

**15**

90°  
Type  
15-4  
15-5  
15-6  
15-7  
15-8  
15-9



### Clamp-on Tee

**16**

Type  
16-5  
16-6  
16-7  
16-8  
16-9



### Clamp-on Crossover

**17**

Type  
17-5  
17-6  
17-7  
17-8  
17-8  
17-9



### Internal Coupling

**18**

Type  
18-6  
18-7  
18-8



### Adjustable Side Outlet Tee

**19\***

Type  
19-5  
19-6  
19-7  
19-8  
19-85  
19-9



### Side Outlet Elbow

**20**

Type  
20-4  
20-5  
20-6  
20-7  
20-8  
20-9



### Side Outlet Tee

**21**

90°  
Type  
21-4  
21-5  
21-6  
21-7  
21-8  
21-8  
21-9



### Split Two Socket Side Outlet Tee

**A21**

90°  
Type  
A21-8



### Three Socket Tee





























**25**

Type  
25-4  
25-5  
25-6  
25-7  
25-8  
25-9



EXAMPLE

\*Normally used in pairs but sold and priced separately.

<b>Split Two Socket Cross</b> <b>A26</b>  Type A26-8	<b>Single Socket Tee</b> <b>29</b> 30°-60°  Type 29-6 29-7 29-8	<b>Adjustable Cross</b> <b>30</b> 30°-45°  Type 30-6 30-7 30-8	<b>Pallet Flange</b> <b>31</b>  Type 31-8	<b>Decorative Ball</b> <b>32</b>  Type 32-7 32-8	<b>Two Socket Cross</b> <b>26</b>  Type 26-3 26-4 26-5 26-6 26-7 26-8 26-87 26-9
<b>Three Socket Cross</b> <b>35</b>  Type 35-4 35-5 35-6 35-7 35-8 35-9	<b>Split Three Socket Cross</b> <b>A35</b>  Type A35-8	<b>Four Socket Cross</b> <b>40</b>  Type 40-4 40-5 40-6 40-7 40-8 40-9	<b>Split Four Socket Cross</b> <b>A40</b>  Type A40-8	<b>Crossover</b> <b>45</b>  Type 45-3 45-4 45-5 45-6 45-7 45-8 45-86 45-87 45-9 45-98	<b>Split Crossover</b> <b>A45</b>  Type A45-7 A45-8
<b>Combination Socket Tee and Crossover</b> <b>46</b>  Type 46-4 46-5 46-6 46-7 46-8 46-9	<b>Single Swivel Swivel</b> <b>C50</b>  Type C50-44 C50-55 C50-66 C50-77 C50-88 C50-99	<b>Female Single Swivel Socket Member</b> <b>F50</b>  Type F50-4 F50-5 F50-6 F50-7 F50-8 F50-9	<b>Male Single Swivel Socket Member</b> <b>M50</b>  Type M50-4 M50-5 M50-6 M50-7 M50-8 M50-9	<b>Male Single Horizontal Swivel Socket Member</b> <b>MH50</b>  Type MH50-6	<b>Modified M50-8 with Offset Slot</b> <b>P50</b>  Type P50-8
<b>Double Swivel Socket</b> <b>C51</b>  Type C51-555 C51-666 C51-777 C51-888 C51-999	<b>Male Double Swivel Socket Member</b> <b>M51</b>  Type M51-5 M51-6 M51-7 M51-8 M51-9	<b>Male Double Horizontal Swivel Socket Member</b> <b>MH51</b>  Type MH51-6	<b>Modified M51-8 with Offset Slots</b> <b>P51</b>  Type P51-8	<b>Corner Swivel Socket</b> <b>C52</b>  Type C52-555 C52-666 C52-777 C52-888	<b>Male Corner Swivel Socket Member</b> <b>M52</b>  Type M52-5 M52-6 M52-7 M52-8
<b>Swivel Elbow</b> <b>BC53</b>  Type BC53-66 BC53-77 BC53-88	<b>Adjustable Three Way Swivel Socket</b> <b>C53</b>  Type C53-888	<b>Variable Angle Double Swivel Socket Member</b> <b>M53</b>  Type M53-8	<b>Obtuse Angle Elbow</b> <b>55</b>  Type 55-6 55-7 55-8	<b>Variable Elbow</b> <b>55A</b> 11°-30°  Type 55A-7 55A-8	<b>Acute Angle Elbow</b> <b>56</b> 30°-45°  Type 56-7 56-8
<b>Acute Angle Elbow</b> <b>56A</b> 11°-30°  Type 56A-7 56A-8	<b>Modified M50-8 with Slot</b> <b>P57</b>  Type P57-8	<b>Modified P57</b> <b>P57E</b>  Type P57E-7	<b>Swivel Flange</b> <b>C58</b>  Type C58-5 C58-6 C58-7 C58-8 C58-9	<b>Swivel Flange Plate</b> <b>M58</b>  Type P58-7	<b>Double Central Flange Fitting</b> <b>P58</b>  Type P58-7
<b>Spigot Flange</b> <b>59</b>  Type 59-5 59-6 59-7 59-8 59-9	<b>Extra Heavy Flange</b> <b>60</b>  Type 60-5 60-6 60-7 60-8	<b>Flange</b> <b>61</b>  Type 61-3 61-4 61-5 61-6 61-7 61-8 61-9	<b>Standard Railing Flange</b> <b>62</b>  Type 62-5 62-6 62-7 62-8 62-9	<b>Angle Base Flange</b> <b>63</b> 45°-60°  Type 63-6 63-7 63-8	<b>Standard Vertical Railing Base</b> <b>64</b>  Type 64-6 64-7 64-8
<b>Standard Horizontal Railing Base</b> <b>65</b>  Type 65-6	<b>Ground Socket</b> <b>66</b>  Type 66-6 66-7 66-8	<b>Angle Flange</b> <b>67</b> 3°-11°  Type 67-7 67-8	<b>Wall Flange</b> <b>68</b>  Type 68-6 68-7 68-8	<b>Railing Flange with Toeboard Adapter</b> <b>69</b>  Type 69-6 69-7 69-8	<b>Rail Support</b> <b>70</b>  Type 70-5 70-6 70-7 70-8
<b>Weather Cap</b> <b>71</b>  Type 71-6 71-7 71-8	<b>Stair Tread Support</b> <b>72</b>  Type 72-8	<b>Collar</b> <b>75</b>  Type 75-4 75-5 75-6 75-7 75-8	<b>Hook</b> <b>76</b>  Type 76-5 76-6 76-7 76-8	<b>Plastic Plug</b> <b>77</b>  Type 77-4 77-5 77-6 77-7 77-8 77-9	<b>Eye Fitting</b> <b>78</b>  Type 78-5 78-6 78-7 78-8

<b>Sheeting Clip</b> <b>79</b>  Type 79-7	<b>Single Sided Clip</b> <b>81</b>  Type 81-5 81-6 81-7 81-8 81-9	<b>Double Sided Clip</b> <b>82</b>  Type 82-5 82-6 82-7 82-8 82-9	<b>Pin Fitting</b> <b>83</b>  Type 83-5 83-6 83-7 83-8	<b>Malleable Plug</b> <b>84</b>  Type 84-5 84-6 84-7 84-8 84-9	<b>Angle Tee</b> <b>86</b> 0°-11°  Type 86-7 86-8
<b>Angle Elbow</b> <b>87</b> 0°-11°  Type 87-7 87-8	<b>Three Socket Angle Tee</b> <b>88</b> 0°-11°  Type 88-7 88-8	<b>Two Socket Angle Cross</b> <b>89</b> 0°-11°  Type 89-7 89-8 89-87	<b>PGR Three Socket Tee</b> <b>90</b>  Type 90-8	<b>PGR Two Socket Tee</b> <b>91</b>  Type 91-8	<b>PGR Elbow</b> <b>92</b>  Type 92-8
<b>PGR Tee</b> <b>93</b>  Type 93-8	<b>Set Screws</b> <b>97</b>  Type 97-3 97-4 97-56 97-56S* 97-789 97-789S*	<b>Anti-Theft Device</b> <b>97ATD</b>  Type 98-3 98-4 98-56 98-789	<b>Hex Key</b> <b>99</b>  Type 98-3 98-4 98-56 98-789	<b>Plastic Set Screw Cap</b> <b>100</b>  Type 100-56 100-789	<b>Sheeting Clip without Hardware</b> <b>105</b>  Type 105-6 105-7 105-8 105-9
<b>Swivel Tee</b> <b>114</b>  Type 114-6 114-7 114-8	<b>Horizontal Raining Base</b> <b>115</b>  Type 115-6 115-7 115-8	<b>Packer Plate for Type 115</b> <b>S115</b>  Type 118-8	<b>Cover Flange</b> <b>118</b>  Type 118-8	<b>Corner Crossover</b> <b>121</b>  Type 121-7	<b>Crossover Coupling</b> <b>145</b>  Type 145-7
<b>Toeboard</b> <b>TB150</b>  Type TB150 Aluminium Toeboard TB2 Straight Connector TB2C Right Angle Connector TFPF1 Fixing Pack TB3-7 Saddle Bracket TB3-8 Saddle Bracket	<b>Single Sided Fixing Bracket</b> <b>199</b>  Type 199-6 199-7 199-8	<b>Double Sided Fixing Bracket</b> <b>200</b>  Type 200-6 200-7 200-8	<b>Round Base Flange</b> <b>262</b>  Type 262-8	<b>Offset Rail Wall Flange</b> <b>265</b>  Type 265-7 265-8	<b>Parapet Flange</b> <b>316</b>  Type 316-7 316-8
<b>Left Hand Level to Sloping Down Side Outlet Elbow</b> <b>320LH</b> 30°-45°  Type 320LH-7 320LH-8	<b>Right Hand Level to Sloping Down Side Outlet Elbow</b> <b>320RH</b> 30°-45°  Type 320RH-7 320RH-8	<b>Left Hand Level to Sloping Down Side Outlet Tee</b> <b>321LH</b> 30°-45°  Type 321LH-7 321LH-8	<b>Right Hand Level to Sloping Down Side Outlet Tee</b> <b>321RH</b> 30°-45°  Type 321RH-7 321RH-8	<b>Level to Sloping Down Tee</b> <b>325</b> 30°-45°  Type 325-7 325-8	<b>Level to Sloping Up Tee</b> <b>325A</b> 30°-45°  Type 325A-7 325A-8
<b>Level to Sloping Down or Up Cross</b> <b>326</b> 30°-45°  Type 326-7 326-8	<b>Three Socket Tee</b> <b>327</b> 11°-30°  Type 327-7 327-8	<b>Two Socket Cross</b> <b>328</b> 11°-30°  Type 328-7 328-8	<b>Single Socket Tee</b> <b>329</b> 11°-30°  Type 329-7 329-8	<b>Eaves Fitting</b> <b>350</b>  Type 350-8	<b>Ridge Fitting</b> <b>351</b>  Type 351-8
<b>Angle Base Flange</b> <b>363</b> 11°-30°  Type 363-7 363-8	<b>Three Socket Tee</b> <b>427</b> 30°-45°  Type 427-7 427-8	<b>High Capacity Base Flange</b> <b>623</b>  Type 623-8 623-9	<b>Vertical Infill Panel - 1500mm wide</b> <b>VBI150GV</b> 		
<b>Vertical Infill Panel - 1000mm wide</b> <b>VBI100GV</b> 					





KEE LITE Fitting Size	Tube Diameter Ø mm O/D
6	33.7
7	42.4
8	48.3
9	60.3

Lightweight **CORROSION RESISTANT** solution for the construction of safety railing



# Aluminium Barrier Solutions

## Key Features

KEE LITE aluminium components offer lightweight flexible solutions for the construction of safety railing, handrail, guardrail and barriers.

Manufactured from a high-grade Aluminium Silicon Magnesium Alloy, KEE LITE fittings are much lighter than ordinary fittings and extremely durable; even in harsh environments.

Aluminium provides high corrosion resistance while the integral stainless steel set screws in each fitting, designed to lock the product safely and securely onto its respective tube, deliver an excellent slip load performance. This technology, already well proven in the market leading range of KEE KLAMP fittings, eliminates the need for time consuming welding or specialist installation skills, so helping to reduce structure assembly time and lower project costs even further.

The KEE LITE range has gained TÜV approval for the main components after undergoing extensive testing.

## Technical Information

KEE LITE aluminium fittings are available in four sizes to suit different tube diameters. The fittings are made from high grade Aluminium Silicon Magnesium Alloy. Recommended set screw torque is 39Nm. Minimum slip load capacity on aluminium tube: 7.56kN (safety factor = 2 with tube having a minimum UTS of 275 N/mm<sup>2</sup>).

## Specifying KEE LITE Components

Each fitting has a simple numerical code reference, which defines the type of fitting and the pipe size, or sizes, it is designed to receive. The first number, preceding the dash (-) identifies the type of KEE LITE fitting. A single digit, following the dash, defines tube size. Two single digits after the dash indicate that the fitting is designed to receive two sizes of tube. Refer to example on page 8-9 for selecting KEE LITE fitting.

## Features & Benefits

- Superior corrosion resistance, strength and durability
- Ideal handrail solution for harsh environments
- Use standard tube
- No welding, threading or bolting required
- Quick installation / Cost-effective
- Flexible systems allow on-site alterations



**Single Swivel Socket**  
**LC50\*1**



Type  
LC50-66  
LC50-77  
LC50-88

**Female Single Swivel Socket Member**  
**LF50\*1**



Type  
LF50-6  
LF50-7  
LF50-8

**Male Single Swivel Socket Tee**  
**LM50**



Type  
LM50-6  
LM50-7  
LM50-8

**Double Swivel Socket**  
**LC51**



Type  
LC51-666  
LC51-777  
LC51-888

**Male Double Swivel Socket Member**  
**LM51**



Type  
LM51-6  
LM51-7  
LM51-8

**Corner Swivel Socket**  
**LC52**



Type  
LC52-666  
LC52-777  
LC52-888

**Male Corner Swivel Socket Member**  
**LM52**



Type  
LM52-6  
LM52-7  
LM52-8

**Adjustable Elbow**  
**LB54**  
45°-200°



Type  
LB54-66  
LB54-77  
LB54-88

**Obtuse Angle Elbow**  
**L55**



Type  
L55-7  
L55-8

**Variable Elbow**  
**L55A**



Type  
L55A-7  
L55A-8

**Acute Angle Elbow**  
**L56**  
30°-45°



Type  
L56-7  
L56-8

**Acute Angle Elbow**  
**L56A**  
11°-30°



Type  
L56A-7  
L56A-8

**Swivel Flange**  
**LC58\*1\*2**



Type  
LC58-6  
LC58-7  
LC58-8

**Swivel Flange Plate**  
**LM58**



Type  
LM58-8

**Flange**  
**L61\*3**



Type  
L61-6  
L61-7  
L61-8

**Standard Railing Flange**  
**L62**



Type  
L62-6  
L62-7  
L62-8

**Angle Base Flange**  
**L63**  
45°-60°



Type  
L63-7  
L63-8

**Angle Flange**  
**L67**



Type  
L67-8

**Wall Flange**  
**L68**



Type  
L68-6  
L68-7  
L68-8

**Railing Flange with Toeboard Adapter**  
**L69**



Type  
L69-7  
L69-8

**Rail Support**  
**L70\*4**



Type  
L70-6  
L70-7  
L70-8

**Metal Plug**  
**L84**



Type  
L84-6  
L84-7  
L84-8

**Swivel Tee**  
**L114**



Type  
L114-6  
L114-7  
L114-8

**Heavy Duty Rectangular Flange**  
**L148**



Type  
L148-9/2  
L148-9/4

**Heavy Duty Four Hole Square Flange**  
**L150**



Type  
L150-8

**Four Hole Square Flange**  
**L152**



Type  
L152-6  
L152-7  
L152-8

**Smooth Handrail Fitting**  
**L160**



Type  
L160-7  
L160-8

**Offset Wall Flange**  
**L164**



Type  
L164-8

**Round Base Flange**  
**L262**



Type  
L262-7  
L262-8

**Left Hand Level to Sloping Down Side Outlet Elbow**  
**L320LH**  
30°-45°



Type  
L320LH-7  
L320LH-8

**Right Hand Level to Sloping Down Side Outlet Elbow**  
**L320RH**  
30°-45°



Type  
L320RH-7  
L320RH-8

**Left Hand Level to Sloping Down Side Outlet Tee**  
**L321LH**  
30°-45°



Type  
L321LH-7  
L321LH-8

**Right Hand Level to Sloping Down Side Outlet Tee**  
**L321RH**  
30°-45°



Type  
L321RH-7  
L321RH-8

**Level Sloping Down Tee**  
**L325**  
30°-45°



Type  
L325-7  
L325-8

**Level Sloping Up Tee**  
**L325A**  
30°-45°



Type  
L325A-7  
L325A-8

**Level to Sloping Down or Up Cross**  
**L326**  
30°-45°



Type  
L326-7  
L326-8

**Three Socket Tee**  
**L427**  
30°-45°



Type  
L427-7  
L427-8

**Neoprene Gaskets**  
**Gaskets**



Type  
See Gaskets  
Table below



# Safety Loading Standards

Kee Safety barrier systems meet every safety loading standard up to 1500 Newtons per Metre (N/m) in practically every location.

360 Newtons per metre run (N/m) Industrial Use-Non Emergency  
 740 Newtons per metre run (N/m) Commercial Use  
 1500 Newtons per metre run (N/m) Retail/Public Access

The current regulations give various design requirements to be fulfilled of which the Design Load is the most important.

Kee Klamp Load Chart	Tube Size	6 3.2mm	7 3.2mm	7 4mm	8 3.2mm	8 4mm	8 5mm	9 3.65mm	9 4.5mm
	Grade	BS EN 10255 Medium	BS EN 10255 Medium	BS EN 10255 Heavy	BS EN 10255 Medium	BS EN 39	EN 10210 S355 JOH	BS EN 10255 Medium	BS EN 10255 Heavy
<b>Design Load Criteria</b>	<b>Upright Height 900mm</b>								
<b>360 N/m</b>	<b>814mm</b> (4.44KN)	<b>1369mm</b> (6.52KN)	<b>1595mm</b> (7.60KN)	<b>1828mm</b> (7.73KN)	<b>2584mm</b> (10.92KN)	<b>3052mm</b> (12.90KN)	<b>3265mm</b> (13.80KN)	<b>3856mm</b> (14.75KN)	
<b>740 N/m</b>	<b>396mm</b> (4.44KN)	<b>666mm</b> (6.52KN)	<b>776mm</b> (7.60KN)	<b>889mm</b> (7.73KN)	<b>1257mm</b> (10.92KN)	<b>2229mm</b> (19.36KN)	<b>1588mm</b> (13.80KN)	<b>1876mm</b> (14.75KN)	
<b>1500 N/m</b>	<b>195mm</b> (4.44KN)	<b>329mm</b> (6.52KN)	<b>383mm</b> (7.60KN)	<b>439mm</b> (7.73KN)	<b>620mm</b> (10.92KN)	<b>1100mm</b> (19.36KN)	<b>784mm</b> (13.80KN)	<b>925mm</b> (14.75KN)	
<b>Design Load Criteria</b>	<b>Upright Height 1000mm</b>								
<b>360 N/m</b>	<b>732mm</b> (4.44KN)	<b>1232mm</b> (6.52KN)	<b>1435mm</b> (7.60KN)	<b>1645mm</b> (7.73KN)	<b>2326mm</b> (10.92KN)	<b>2930mm</b> (13.76KN)	<b>2939mm</b> (13.80KN)	<b>3470mm</b> (14.75KN)	
<b>740 N/m</b>	<b>356mm</b> (4.44KN)	<b>599mm</b> (6.52KN)	<b>698mm</b> (7.60KN)	<b>800mm</b> (7.73KN)	<b>1131mm</b> (10.92KN)	<b>2006mm</b> (19.36KN)	<b>1430mm</b> (13.80KN)	<b>1688mm</b> (14.75KN)	
<b>1500 N/m</b>	<b>176mm</b> (4.44KN)	<b>296mm</b> (6.52 KN)	<b>345mm</b> (7.60KN)	<b>395mm</b> (7.73KN)	<b>558mm</b> (10.92KN)	<b>990mm</b> (19.36 KN)	<b>705mm</b> (13.80 KN)	<b>833mm</b> (14.75 KN)	
<b>Design Load Criteria</b>	<b>Upright Height 1100mm</b>								
<b>360 N/m</b>	<b>666mm</b> (4.44KN)	<b>1120mm</b> (6.52KN)	<b>1305mm</b> (7.60KN)	<b>1496mm</b> (7.73KN)	<b>2114mm</b> (10.92KN)	<b>2778mm</b> (14.35KN)	<b>2671mm</b> (13.80KN)	<b>3155mm</b> (14.75KN)	
<b>740 N/m</b>	<b>324mm</b> (4.44KN)	<b>545mm</b> (6.52KN)	<b>635mm</b> (7.60KN)	<b>728mm</b> (7.73KN)	<b>1028mm</b> (10.92KN)	<b>1824mm</b> (19.36KN)	<b>1300mm</b> (13.80KN)	<b>1535mm</b> (14.75KN)	
<b>1500 N/m</b>	<b>160mm</b> (4.44KN)	<b>269mm</b> (6.52KN)	<b>313mm</b> (7.60KN)	<b>359mm</b> (7.73KN)	<b>507mm</b> (10.92KN)	<b>900mm</b> (19.36KN)	<b>641mm</b> (13.80KN)	<b>757mm</b> (14.75KN)	

Base upon rail diameter being the same as the upright but using BS EN 10255 medium wall tubing.

Design Loads are as stated in BS 8118, BS 6180, BS 6399 & BS 7818.

The above bay sizes are based upon using the KEE KLAMP Type 62 base fitting fixed perpendicular to the line of the handrails.

The figures shown in brackets are the required anchor pull out loads for the bay size indicated after all reduction factors have been applied.

### Notes

- The table is based on the maximum permissible bending moment of the tube
- All rails are the same tube size as uprights but in BS EN 10255 medium grade tube
- Where tube is to be used to form ground sockets:  
 Tube size 6 fits inside tube size 7 medium grade only  
 Tube size 8 fits inside tube size 9 all grades.

Based upon rail diameter being the same size & grades as the upright. Design Loads are as stated in BS 8118, BS 5950, BS 6180, BS 6399 & BS 7818. To achieve bigger bay sizes than those stated please contact Kee Safety Ltd for further details.

KEE LITE components are made from high grade Aluminium Silicon Magnesium Alloy.

- Recommended set screw torque is 39Nm
- Minimum slip load capacity on aluminium tube: 7.56KN (safety factor = 2 with tube having a minimum UTS of 275 N/mm<sup>2</sup>)
- Large grub screws are designed to resist thread stripping
- The core range of KEE LITE fittings has undergone independent testing by TÜV.

Kee Lite Load Chart	Tube Size	6 3.38mm	7 3.56mm	8 4.05mm	9 4.06mm
	Grade	6082 T6	6082 T6	6082 T6	6082 T6
<b>Design Load Criteria</b>	<b>Upright Height 900mm</b>				
<b>360 N/m</b>	<b>720mm</b>	<b>1388mm</b>	<b>1879mm</b>	<b>2490mm</b>	
<b>740 N/m</b>	<b>N/A</b>	<b>N/A</b>	<b>1220mm</b>	<b>1940mm</b>	
<b>Design Load Criteria</b>	<b>Upright Height 1000mm</b>				
<b>360 N/m</b>	<b>540mm</b>	<b>1117mm</b>	<b>1664mm</b>	<b>2370mm</b>	
<b>740 N/m</b>	<b>N/A</b>	<b>N/A</b>	<b>950mm</b>	<b>1690mm</b>	
<b>Design Load Criteria</b>	<b>Upright Height 1100mm</b>				
<b>360 N/m</b>	<b>400mm</b>	<b>871mm</b>	<b>1398mm</b>	<b>2205mm</b>	
<b>740 N/m</b>	<b>N/A</b>	<b>N/A</b>	<b>730mm</b>	<b>1400mm</b>	



The most flexible safety solution for **HANDRAILS** COMPLIANT WITH THE EQUALITY ACT



# Handrails for People with Disabilities

## Key Features

KEE ACCESS components are used to create safety handrails and barriers compliant with disability legislation. The KEE ACCESS range of cast iron fittings was developed to help satisfy the requirements of the Equality Act 2010.

Under the terms of the Equality Act, reasonable adjustments need to be made to public and commercial establishments to overcome physical barriers which prevent disabled access. The Building Regulations recommend an outside diameter tube size for installations of between 40mm - 45mm. KEE ACCESS components are specifically designed to give a smooth and continuous handrail with size 7 tube (outside diameter 42.4mm) ensuring compatibility with the regulations.

All fittings can be powder coated in a choice of RAL colours to meet the visibility and 'not cold to the touch' requirements of the building regulations. These fittings are ideal as a retrofit solution, because the range includes an "Add-on" offset fitting to allow a new handrail to be added onto an existing structure of appropriate size.

## Compliance

- Conforms to regulatory requirements of the Equality Act
- Meets the requirements of Building Regulations Part M and British Standard BS 8300

## Features & Benefits

- Meet the requirements of the Equality Act 2010 and Building Regulation Approved Document M
- Combining 42.2mm handrail with 48.3mm uprights ensures a rigid, sturdy installation
- Add-on components allow non-compliant systems to be upgraded
- Available in all RAL colours to contrast with the surroundings
- A flexible system that can accommodate on site variations
- Cost effective to install - no welding, threading or bolting required

## Technical Information

KEE ACCESS fittings are designed to suit BS EN 10255 (ISO 65) steel tubes. Fittings are made of galvanised cast iron to BS EN ISO 1461 for long term maintenance.





Upright  
**PROTECTORS**  
FOR WAREHOUSES  
Modular. Easy to  
install. Hi-vis.



# Warehouse Barriers

## Key Features

Avoid machinery collisions into walls, corners, racking units, posts and pipes with our range of upright protectors.

Suitable for warehouses, factories, public buildings or office blocks, the range can be used both indoors and outdoors. Made of hot dipped galvanised steel for durability, our uprights are also powder coated in RAL 1021 (Rape Seed Yellow) for extra visibility.

The KWIK KIT range of warehouse protectors has been designed and tested in accordance with the BS EN 15512:2009. The standard states that an upright protector should be positioned at the end of each run of racking between cross-aisles and at uprights, which are positioned at aisle and gangway intersections. The KWIK KIT uprights are all a minimum of 400mm tall, and dynamic tests have been conducted to ensure that the minimum energy absorption of 400Nm is achieved. All KWIK KIT barriers are manufactured from size 8 (48.300mm) KEE KLAMP fittings and tubing with a 3.2mm wall.

## Compliance

- BS EN 15512:2009

## Applications

- An upright protector with a min height of 400 mm needs to be positioned at the end upright of each run of racking between cross-aisles.
- An upright protector shall be positioned at those uprights positioned at all aisle and gangway intersections.
- The upright protector will absorb an energy of at least 400Nm in any direction at any height between 100 and 400mm.

### Warehouse Corner Protector

Part No	Height (mm)	Width (mm)	Depth (mm)
CB0500PC	500	500	500



### Pipe Protection Barrier

Part No	Height (mm)	Width (mm)	Depth (mm)
PB1000PC	1000	300	300
PB1500PC	1500	300	300



### Racking Protection Barrier

Part No	Height (mm)	Width (mm)	Depth (mm)
RB0750PC	750	750	n/a
RB1000PC	1000	750	n/a
RB1250PC	1250	750	n/a



### Service Protection Barrier

Part No	Height (mm)	Width (mm)	Depth (mm)
SB0500PC	500	500	500
SB0750PC	750	500	500



### Structural Protection Barrier

Part No	Height (mm)	Width (mm)	Depth (mm)
ST0500PC	500	500	500
ST1000PC	1000	500	500
ST1500PC	1500	500	500



### Vertical Protection Barrier

Part No	Height (mm)	Width (mm)	Depth (mm)
VB1000PC	1000	300	300
VB1500PC	1500	300	300





**Kee<sup>®</sup>  
Gate**



**FULLY  
ADJUSTABLE  
GATES** for varying  
widths cut/adjustable  
on site during  
install



# Self Closing Safety Gates

## Key Features

KEE GATE self closing safety gates are ideal for protecting access and egress on rooftops and in industrial environments. The gates have been designed to easily fit to new or existing structures wherever a gate is required. Each safety gate is spring loaded so it automatically closes behind the user. This overcomes the potential for human error that is often associated with traditional forms of protection such as chains or bars where incorrect usage can lead to the creation of a hazardous void.

KEE GATE self closing safety gates are made from galvanised steel and **can be cut down to size to fit into the required opening**. The gates can be supplied powder coated in RAL 1021 (Rape Seed Yellow) for extra visibility.

## Compliance

The KEE GATE range has been independently tested to ensure the gates comply with international standards such as EN 13374 and EN 14122 Parts 3 and 4.

## Applications

- Single width gates for openings up to 1m
- Double width gates for larger openings greater than 1m wide
- Full height gates for ladders, designed to comply with EN 4211: specification for Permanently Fixed Ladders



No.	Part Name	Part Code
<b>SINGLE WIDTH GATES</b>		
1	Single EU Gate - Galvanised	SGEUGV2
1	Single EU Gate - Powder Coated	SGEUPC2
<b>DOUBLE WIDTH GATES</b>		
2	Double Gate - Galvanised	SGEUDGV2
2	Double Gate - Powder Coated	SGEUDPC2
<b>FULL HEIGHT GATE</b>		
3	Single Full Height EU Gate - Galvanised	SGEUFGV
3	Single Full Height EU Gate - Powder Coated	SGEUFPC

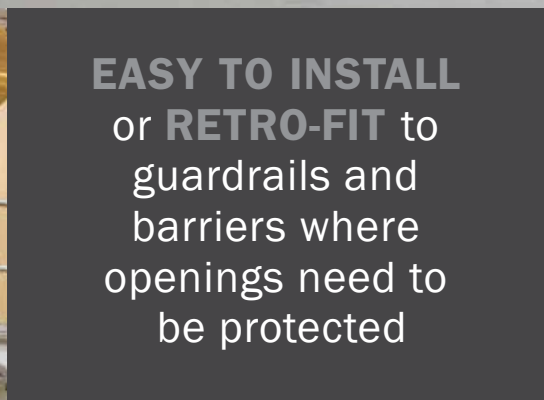

**EASY TO INSTALL**  
or **RETRO-FIT** to  
guardrails and  
barriers where  
openings need to  
be protected

# Pallet Gates

## Key Features

Kee Safety's pallet gates have been designed specifically to allow goods to be moved safely up or down from mezzanines or raised working surfaces.

The range is easy to install or retro-fit to guardrails and barriers where openings need to be protected, such as on mezzanines in warehouses and logistics centres. Each gate is counterbalanced for a positive open and close action, adding to the gate's ease of operation.

KEE GATE pallet gates are fully adjustable in width and are available in four different models to accommodate the type of operation required.

## Compliance

- EN ISO 14122 Part 3 : 2016

## Features & Benefits

- Available in Galvanised Steel or Aluminium
- Constructed from KEE KLAMP and KEE LITE fittings
- Cycle tested for 50,000 openings for guaranteed durability
- Salt spray tested for corrosion resistance
- Supplied part assembled for ease of on-site installation

No.	Part Name	Part Code
1	Pallet Gate Type A - Galvanised (1.48m x 1.40m) 91Kg	SGPGTYAGV
1	Pallet Gate Type A - Powder Coated (1.48m x 1.40m) 91Kg	SGPGTYAPC
2	Pallet Gate Type B - Galvanised (1.48m x 1.40m) 85Kg	SGPGTYBGV
2	Pallet Gate Type B - Powder Coated (1.48m x 1.40m) 85Kg	SGPGTYBPC
3	Pallet Gate Type C - Galvanised (1.48m x 1.40m) 125Kg	SGPGTYCGV
3	Pallet Gate Type C - Powder Coated (1.48m x 1.40m) 125Kg	SGPGTYCPC
4	Pallet Gate Type D - Aluminium (1.9m x 1.4m) 77Kg	SGPGTYDAL
5	Pallet Gate Type F - Galvanised (Max load depth: 1.50m; Max load width: 2.00m; Max load height: 2.50m) 180Kg	SGPGTYFGV

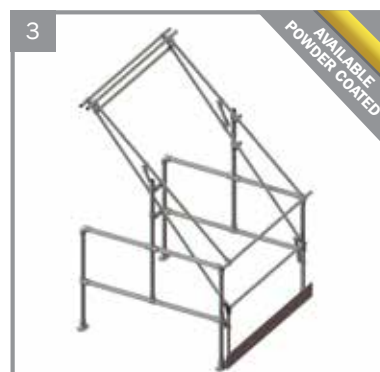

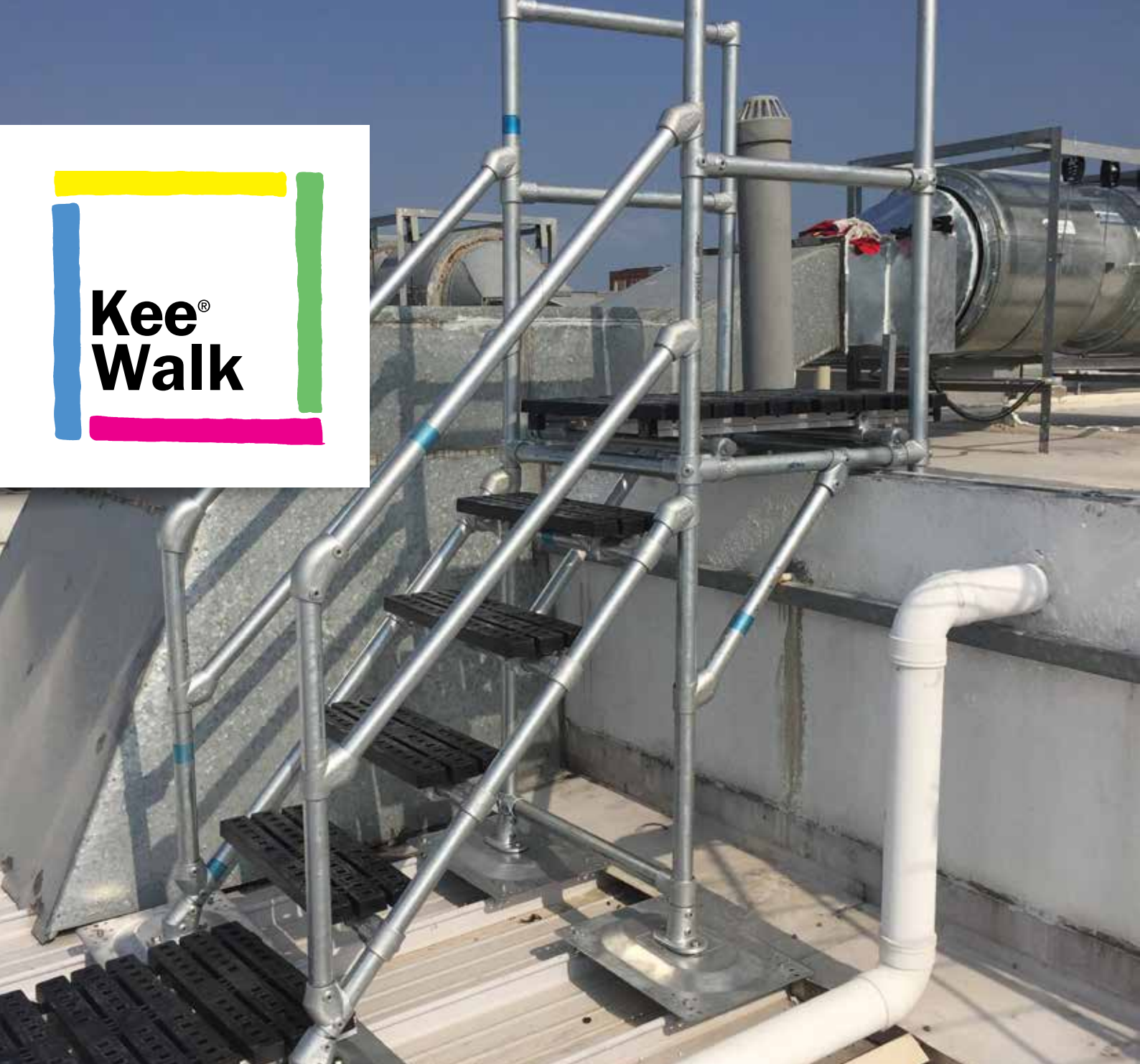

A range of off the shelf or bespoke access platforms\* that provide a **SAFE MEANS OF ACCESS WHERE OBSTRUCTIONS EXIST** or **WHERE A SAFE SOLUTION FOR WORKING AT HEIGHT** at sites with awkward layouts is needed.

\*For bespoke access platforms, please call us on 01384 632 188 or email [sales@keesafety.com](mailto:sales@keesafety.com)





# Safe Access Platforms

## Key Features

A range of off-the-shelf or bespoke access platforms that provide a safe means of access where obstructions exist on a roof such as pipework, plant equipment and conduits or where a safe solution for working at height for sites with awkward layouts is needed.

**Step Overs are available in kit format**, supplied flat packed with full assembly instructions to allow quick and easy installation. The kits are suitable for use on a variety of roof types and surfaces including concrete, membrane, metallic and composite. The standard off-the-shelf kits can accommodate clearance heights of 200mm, 400mm, 600mm, 800mm, 1000mm, 1200mm and 1400mm.

**Bespoke work platforms** and step overs for metal and standing seam roofs can be designed to the specific site requirements and are used for safe access, maintenance and repair in many industries. Please call us on 01384 632 188 or email sales@keesafety.com to discuss your project details.

## Compliance

- BS EN 14122 Part 3
- BS EN 516 for mini step modules

## Features & Benefits

- Step overs suitable for use on all types of roofs
- Also suitable for use in warehouses and factories
- Kits offered in a range of standard sizes
- Bespoke platforms designed to specific site requirements
- Various customised options available (mobile or static; aluminium or steel or GRP; any width and height; for indoor or outdoor; modular or fabricated)
- Supplied flat packed with full assembly instructions

## MINI STEP KIT

Freestanding or fixed.

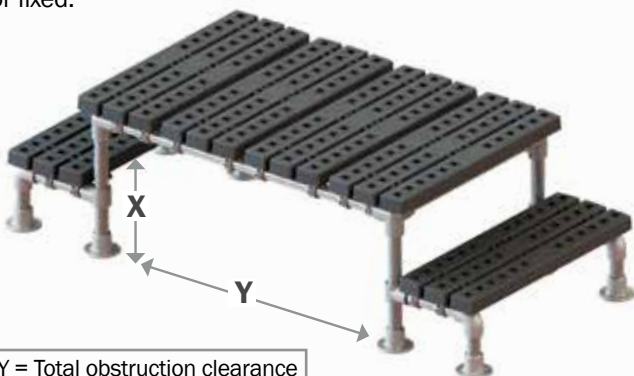

X and Y = Total obstruction clearance

Product Code	Description with obstruction clearance (X&Y)	Total unit Length	Total unit Height
<b>FREESTANDING MINI STEP MODULES + 52kg WEIGHTS</b>			
STMFS2003	Freestanding - 200mm x 240mm	720mm	275mm
STMFS2004	Freestanding - 200mm x 490mm	970mm	275mm
STMFS2005	Freestanding - 200mm x 740mm	1220mm	275mm
STMFS4003	Freestanding - 400mm x 420mm	1161mm	490mm
STMFS4004	Freestanding - 400mm x 670mm	1411mm	490mm
STMFS4005	Freestanding - 400mm x 913mm	1661mm	490mm
<b>MINI STEP MODULES FIXED</b>			
STMFX2003	Fixed - 200mm x 463mm	720mm	275mm
STMFX2004	Fixed - 200mm x 713mm	970mm	275mm
STMFX2005	Fixed - 200mm x 963mm	1220mm	275mm
STMFX4003	Fixed - 400mm x 463mm	1161mm	490mm
STMFX4004	Fixed - 400mm x 713mm	1411mm	490mm
STMFX4005	Fixed - 400mm x 963mm	1661mm	490mm
<b>FREESTANDING STEP OVERS + 112KG WEIGHTS</b>			
STMB600	600mm x 1000mm	3265mm	1900mm
STMB800	800mm x 1000mm	3685mm	2100mm
STMB1000	1000mm x 1000mm	4105mm	2300mm
STMB1200	1200mm x 1000mm	4525mm	2500mm
STMB1400	1400mm x 1000mm	5361mm	2700mm
STMB1212	1200mm x 1200mm	5180mm	2500mm
STMB1414	1400mm x 1400mm	5850mm	2700mm
<b>FIXED STEP OVER</b>			
STCR600	600mm x 1000mm	3265mm	1900mm
STCR800	800mm x 1000mm	3685mm	2100mm
STCR1000	1000mm x 1000mm	4105mm	2300mm
STCR1200	1200mm x 1000mm	4525mm	2500mm
STCR1400	1400mm x 1000mm	5361mm	2700mm
STCR1212	1200mm x 1200mm	4775mm	2500mm
STCR1414	1400mm x 1400mm	5445mm	2700mm

## STEP OVER KIT

Each kit includes a double handrail and toe-boards for added safety.



Call us on **01384 632 188** or email [sales@keesafety.com](mailto:sales@keesafety.com)

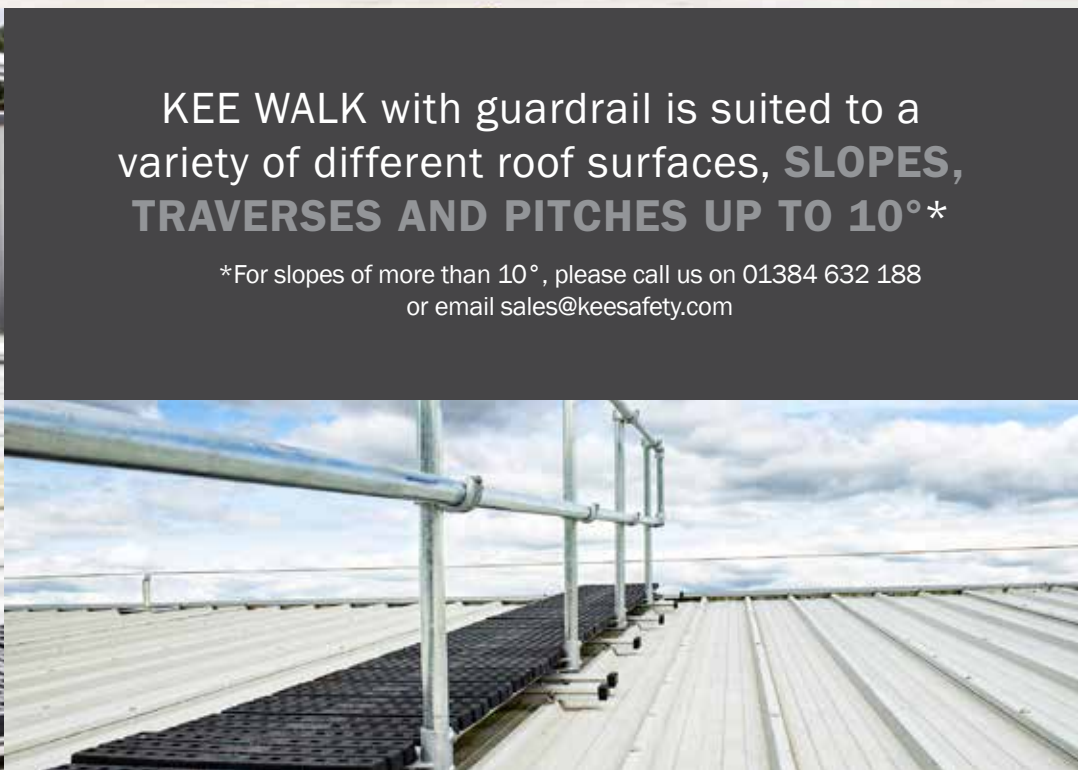

KEE WALK with guardrail is suited to a variety of different roof surfaces, **SLOPES, TRAVERSES AND PITCHES UP TO 10°\***

\*For slopes of more than 10°, please call us on 01384 632 188 or email [sales@keesafety.com](mailto:sales@keesafety.com)

# KEE WALK with Guardrail

## Key Features

The KEE WALK with Guardrail system from Kee Safety is a fall protection solution consisting of walkway and guardrail which can be installed quickly and easily on a wide variety of roofs.

It is a safe, compliant and modular approach to guardrail protection and eliminates the fall hazard typically present when workers are exposed to an unprotected edge whilst accessing or egressing a roof top.

## Compliance

- Guardrail compliant to BS EN 14122-3, BS EN 13374 & OSHA requirements
- Kee Walk Walkway compliant to Pre-Fabricated Accessory EN 516 – Class 1-C

## Features & Benefits

- KEE WALK walkway with guardrail offers a complete safe and cost-effective, non-corrosive protection of the highest order whilst maintaining simple and quick installs
- Can be used in conjunction with our range of steps, platforms and step-overs when negotiating changes in level
- Manufactured in the UK
- Designed for use on all major roofing systems and up to 35° roof pitch
- Slip resistant

No.	Part Name	Part Code
<b>KEE WALK GUARDRAIL MODULES</b>		
1	3m <b>Traverse</b> module with single sided rail	KWGR1S3MT
2	3m <b>Traverse</b> module with double sided rail	KWGR2S3MT
3	3m <b>Longitudinal</b> module with single sided rail	KWGR1S3ML
4	3m <b>Longitudinal</b> module with double sided rail	KWGR2S3ML
<b>HORIZONTAL STEEL TUBE</b>		
5	Rail Tube Sold per m (Typically sold 6.4m or 3.2m)	8-6-G
<b>KEEGUARD - TOE-BOARD</b>		
6	Toe Board (Typically sold 6m)	TB150
7	Straight Connector	TB2
8	Right Angle Connector	TB2C
9	Fixing Pack	TBFP1
<b>KEE KLAMP - COMMON FITTINGS</b>		
10	Straight Coupling	14-8
11	Elbow	15-8
12	Adjustable Elbow	BC53-88
13	Wall Flange	61-8
14	Ladder Clamp	SL109C
<b>KEE WALK – END DETAIL</b>		
15	Corner	WWGRCRN10
16	Single D-Return	WWGRRTS10
17	Double D-Return	WWGRRTD10
18	Single End	WWGRENS10
19	Double End	WWGREND10
<b>KEE WALK FIXING PACK</b>		
20	Metal profile roof fixing pack	WW760FP10
21	Standing seam roof fixing pack	WW764FP10





The safety solution for **FREE-STANDING ROOF EDGE PROTECTION**

# Free Standing Edge Protection

## Key Features

A free-standing fall protection solution that works on a proven counterweight system. KEEGUARD has been designed to provide permanent roof edge protection for areas where regular access for maintenance and inspection is required. **The system does not penetrate the roof membrane.**

By using a KEEGUARD system you can ensure the safety of anyone who has access onto a flat roof. The system is supplied in modular kit format, with a minimum number of assemblies so is quick and easy to install.

KEEGUARD is suitable for use on concrete, asphalt, PVC membrane and felt roof surfaces, up to a 10° pitch.

## Compliance

- EN 13374 Class A / EN ISO 14122 Part 3 / BS 13700 : 2021



No.	Part Name	Part Code
<b>KEEGUARD - UPRIGHT ASSEMBLIES</b>		
1	Upright EN 13374	KGU29
2	Upright with Toe Board bracket (Toe Board separate)	KGU29T
<b>KEEGUARD - UPRIGHT ASSEMBLIES</b>		
3	Upright EN 14122	KGU35
4	Upright with Toe Board bracket (Toe Board separate)	KGU35T
<b>HORIZONTAL STEEL TUBE</b>		
5	Rail Tube Sold per m (Typically sold 6.4m or 3.2m)	8-6-G
<b>KEEGUARD - COUNTER-BALANCE ASSEMBLIES</b>		
6	Intermediate Counterbalance Weight Assembly	CB1P
7	End Counterbalance Assemblies	CB2P
8	End Counterbalance Assemblies	CB3P
9	End Counterbalance Assemblies	CB4P
10	End Counterbalance Assemblies	CB5P
<b>KEEGUARD - TOE-BOARD</b>		
11	Toe Board (Typically sold 6m)	TB150
12	Straight Connector	TB2
13	Right Angle Connector	TB2C
14	Fixing Pack	TBFP1
<b>KEE KLAMP - COMMON FITTINGS</b>		
15	Straight Coupling	14-8
16	Elbow	15-8
17	Adjustable Side Outlet Tee	19-88
18	Wall Flange	61-8
19	Plastic Cap	77-8
20	Adjustable Elbow	BC53-88
21	D-Return	DRET
22	Ladder Clamp	SL109C
<b>KEEGUARD - ELASTOMERIC PADS</b>		
23	400 x 300 x 5 For KGU Mineral Felt	K435
24	400 x 300 x 10 For KGU Asphalt	K4310
25	500 x 500 x 10 For 440 Asphalt	K5510
26	500 x 500 x 5 For 440 Mineral Felt	K5505



# Kee® Guard

Continued...

### Features & Benefits

- Provides collective fall protection for anyone working at heights
- Meets the requirements of the 'Work at Height Regulations'
- Suitable for use on concrete, asphalt, PVC membrane and felt roof surfaces
- Designed to work on roofs up to a 10° pitch
- Wind loading in accordance with AS/NZS 1170.2
- Elastomer pads under the weights prevent damage to the roof surface
- Design load of 300 N/m applied horizontally along the top rail
- Open cup fitting for quick installation
- Sections can be added to and changed on-site

SL109C



Page 29

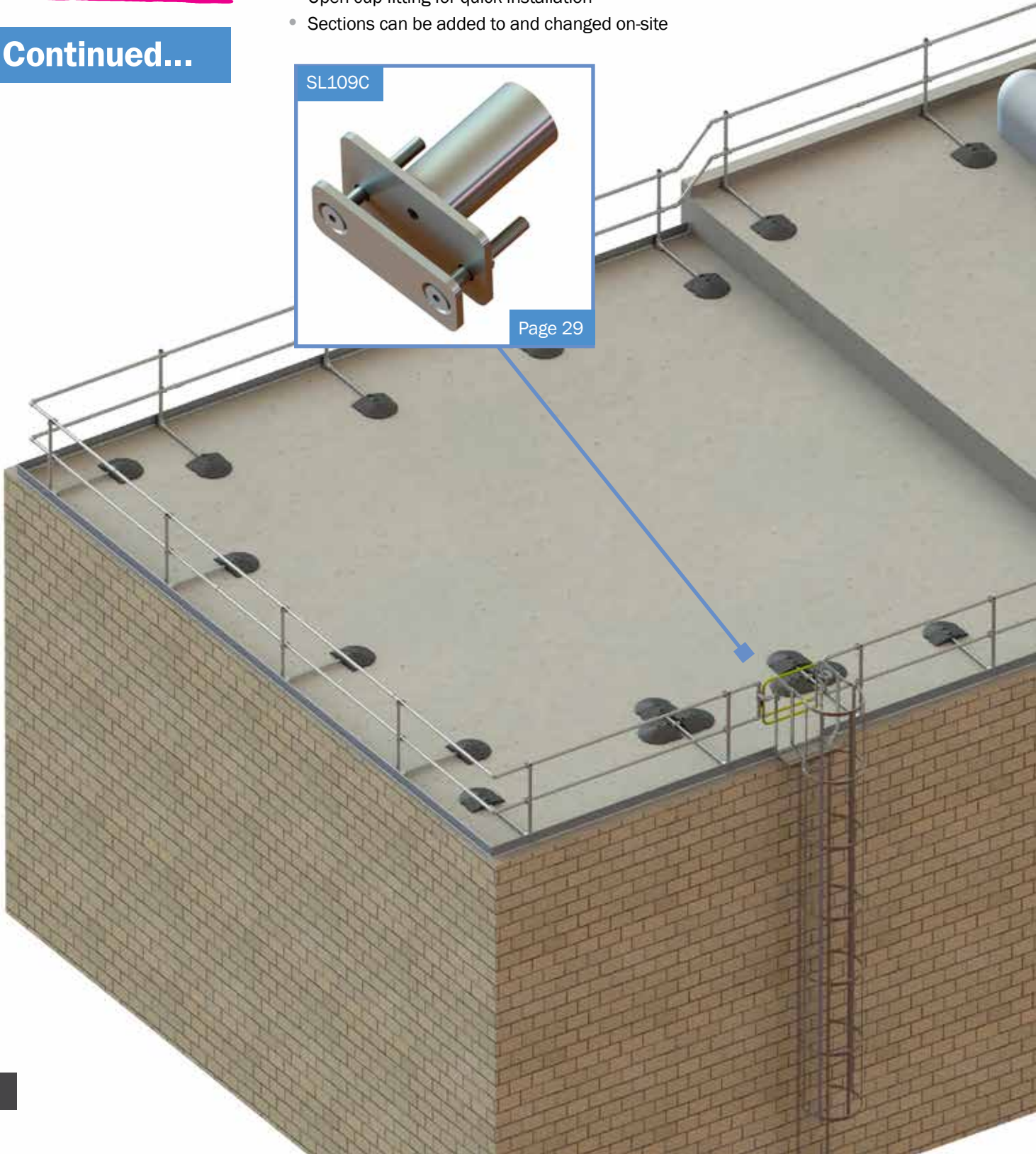

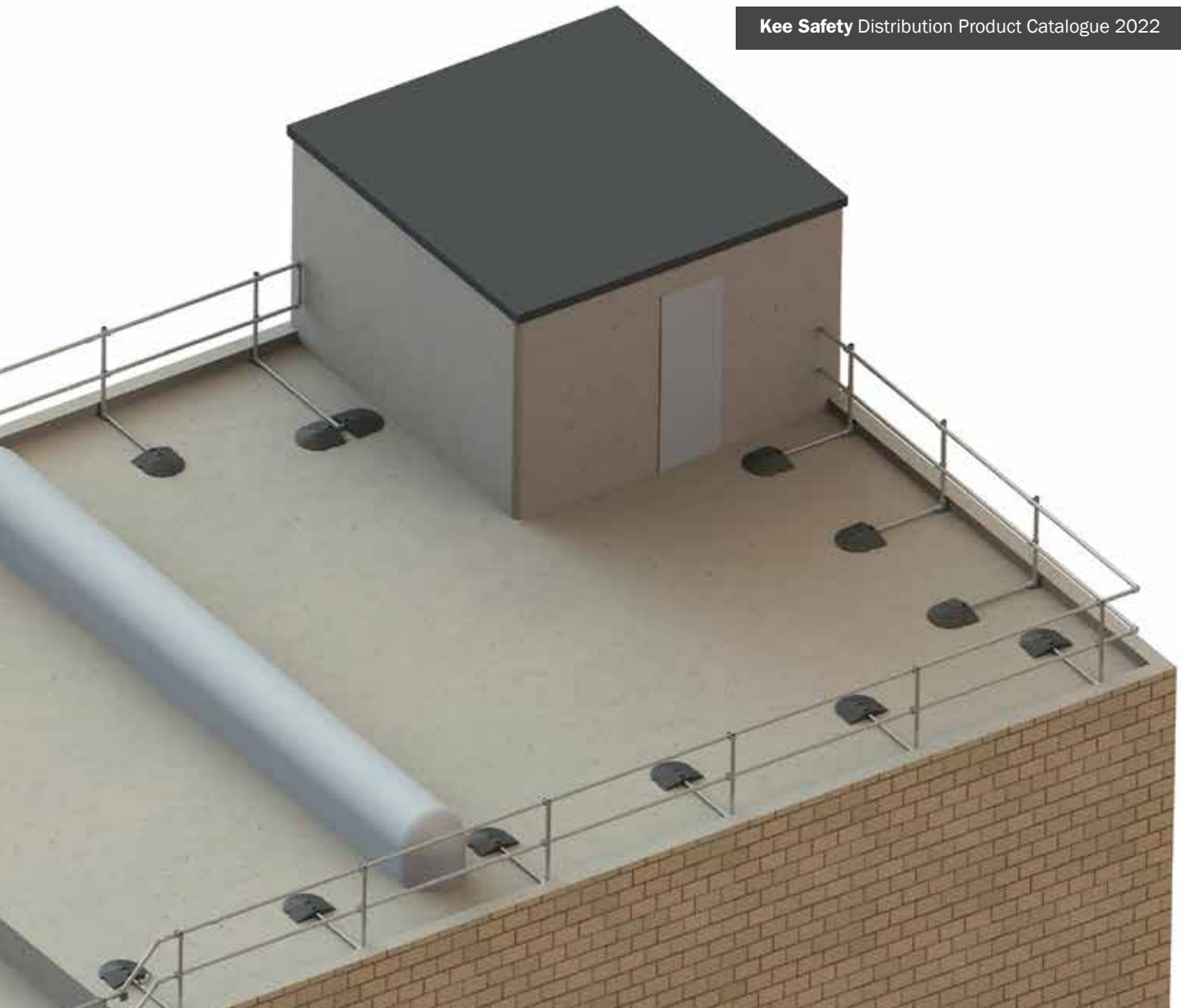

### EN 13374 & BS 13700

Roof Type	MAX Pitch	Tube Size	Tube Thickness	End Counter Balance No.'s	MAX Bay Centres	Intermediate Counter Balance No.'s
<b>Mineral Grade Felt</b>						
Restrained	10°	8	2.9mm	CB2	3m	1
UnRestrained	10°	8	2.9mm	CB3	3m	1
<b>PVC Membrane</b>						
Restrained	10°	8	2.9mm	CB2	3m	1
UnRestrained	10°	8	2.9mm	CB7	3m	1
UnRestrained	5°	8	2.9mm	CB5	3m	1

### EN 14122-3 & NF E85-003

Roof Type	MAX Pitch	Tube Size	Tube Thickness	End Counter Balance	MAX End Bay Length	Intermediate Counter Balance No.'s	MAX Subsequent Bay Lengths
<b>Mineral Grade Felt</b>							
UnRestrained	3°	8	3.2mm	CB4	2m	1	2.4m



**KeeGuard<sup>®</sup>  
Lite**



The aluminium safety solution for **FREE-STANDING ROOF EDGE PROTECTION**



# Aluminium Roof Edge Protection

## Key Features

KEEGUARD Lite provides permanent edge protection for areas where regular access to the roof for maintenance and inspection is required. The system is ideal for harsh environments due to its high corrosion resistance. It can also be used in situations when aesthetics are important.

KEEGUARD Lite incorporates aluminium uprights and tube, and maintains its stability by using a steel base fitting, steel counterbalance arm and a 25Kg weight. As this is a free-standing system, it does not require any physical fixing into the roof's structure/membrane.

## Compliance

- EN 13374 Class A
- EN ISO 14122 Part 3
- BS 13700

## Features & Benefits

- Safe, reliable and versatile collective fall protection solution
- Does not penetrate the roof fabric
- Lightweight & corrosion resistant
- Minimal long-term maintenance keeps on-going costs down
- Available for standard, raked and raked uprights
- Wind loading in accordance with AS/NZS 1170.2

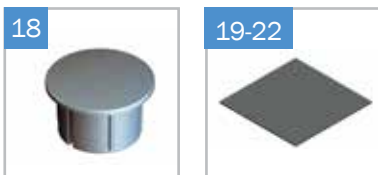

No.	Part Name	Part Code
<b>KEEGUARD LITE - UPRIGHT ASSEMBLIES</b>		
1	Vertical Upright	KGU285
2	Vertical Upright with Toeboard Bracket	KGU285T
<b>TUBE</b>		
3	Rail Tube Aluminum Sold per m (Typically sold 6m or 3m)	8-4-A
<b>COUNTER-BALANCE ASSEMBLIES</b>		
4	Free End Counter Balance Assembly c/w 25kg	CB1P-25
5	Free End Counter Balance Assembly c/w 50kg	CB2P-25
6	Free End Counter Balance Assembly c/w 75kg	CB3P-25
7	Free End Counter Balance Assembly c/w 100kg	CB4P-25
<b>KEEGUARD - TOE-BOARD</b>		
8	Toe Board (Typically sold 6m)	TB150
9	Straight Connector	TB2
10	Right Angle Connector	TB2C
11	Fixing Pack	TBFP1
<b>KEE LITE - COMMON FITTINGS</b>		
12	Single Socket Tee	L10-8
13	Straight Coupling	L14-8
14	Three Socket Tee	L25-8
15	Three Socket Cross	L26-8
16	Adjustable Elbow	LB54-88
17	Wall Flange	L61-8
18	Aluminium Cap	L84-8
<b>KEEGUARD - ELASTOMERIC PADS</b>		
19	400 x 300 x 5 For KGU Mineral Felt	K435
20	400 x 300 x 10 For KGU Asphalt	K4310
21	500 x 500 x 10 For 440 Asphalt	K5510
22	500 x 500 x 5 For 440 Mineral Felt	K5505



Portable  
**FREE-STANDING  
ROOF EDGE**  
protection system

# Portable Roof Edge Protection

## Key Features

KEEGUARD Premium provides an innovative and unrivalled approach to guardrail systems. It is ideal for roofs with limited space such as those where solar panels have been installed.

Designed as a modular free-standing system, a key benefit of KEEGUARD Premium is that it does not require counter weights along the full run of the system. This provides the ideal solution for areas where traditional counter weights are unsuitable or potential trip hazards.

The system is suitable for both temporary and permanent applications on roofs of up to 10° pitch.

## Compliance

- EN 13374 Class A
- BS 13700

## Features & Benefits

- Free standing edge protection
- Ideal for roofs with limited space
- Smaller footprint than counterweighted systems
- Can be used as temporary or permanent protection
- Quick and easy to install
- Wind loading in accordance with AS/NZS 1170.2

No	Part Name	Part Code
<b>KEEGUARD PREMIUM</b>		
1	Upright Assembly Excluding Base	KGUC
2	PVC Base weight 40kg	220-8
<b>COUNTER-BALANCE ASSEMBLIES</b>		
3	End Counterbalance Assemblies	CB3P
<b>STEEL TUBE</b>		
4	Rail Tube Sold per m (Typically sold 6.4m or 3.2m)	8-6-G
<b>KEEGUARD - TOE-BOARD</b>		
5	Toe Board (Typically sold 6m)	TB150
6	Straight Connector	TB2
7	Right Angle Connector	TB2C
8	Fixing Pack	TBFP1
9	Premium Toeboard Plate	TB255
<b>KEE KLAMP - COMMON FITTINGS</b>		
10	Straight Coupling	14-8
11	Elbow	15-8
12	Adjustable Side Outlet Tee	19-88
13	Wall Flange	61-8
14	Plastic Cap	77-8
15	Adjustable Elbow	BC53-88
16	D-Return	DRET
17	Ladder Clamp	SL109C





Roof edge  
protection for  
**STANDING SEAM  
AND CLADDED  
ROOFS**

# Edge Protection for Cladded Roofs

## Key Features

KEEGUARD Topfix provides collective roof edge protection specifically for metal profile and standing seam roofs up to 45° pitch. The system features a base plate with multiple fixing centres which is fixed directly to the profile sheeting via rivets or non-penetrative two-part clamps. The unique plate design allows the system to be fitted to a wide range of profile sheet centres.

The plate also provides the support for the vertical standard leg which can be adjusted from 0° to 11°. The horizontal rails are then simply fitted to the open saddle fittings to provide a complete collective solution.

## Compliance

- EN 13374 Class A / EN ISO 14122 Part 3

## Fixing Centres

- For standing seam roofs: 305, 400 and 500mm
- For trapezoidal profile roof panels: 310, 333, 400 and 500mm

## Features & Benefits

- Suits a wide range of metal profile and standing seam roofs
- Modular off-the-shelf system
- Available in galvanised steel or aluminium finish
- Non-penetrative on standing seam roofs
- Watertight fixings for metal profile roofs maintain the roof's integrity

No.	Part Name	Part Code
<b>KEEGUARD TOPFIX</b>		
1	Upright assembly (c/w baseplate)	KGTF29
2	Upright with Toe Board (Toe Board separate)	KGTFLEG
<b>KEEGUARD TOPFIX - FIXINGS</b>		
3	Keeline 20mm x 3mm Butyl Sealing Strip 15mtr Roll	TA-SEAL
4	7.7 Buld Title Rivit EPDM Sealing Washer Qty 100	KL2RIVIT
5	Standing Seam Clamps Pack of 4	WFP6
<b>STEEL TUBE</b>		
6	Rail Tube - sold per m (Typically sold 6.4m or 3.2m)	8-6-G
<b>KEEGUARD - TOE-BOARD</b>		
7	Toe Board (Typically sold 6m)	TB150
8	Straight Connector	TB2
9	Right Angle Connector	TB2C
10	Fixing Pack	TBFP1
<b>KEE KLAMP - COMMON FITTINGS</b>		
11	Straight Coupling	14-8
12	Elbow	15-8
13	Adjustable Side Outlet Tee	19-88
14	Wall Flange	61-8
15	Plastic Cap	77-8
16	Adjustable Elbow	BC53-88
17	D-Return	DRET





**UNOBTRUSIVE  
EDGE PROTECTION**  
can be folded down  
when not in use



# Folding Free-standing Edge Protection

## Key Features

When collective protection is the preferred method of providing a safe working environment but it is not desirable to have railings permanently visible on the roofline of a building, KEEGUARD Foldshield provides an ideal solution.

Designed for use on slopes up to 10° the system is suitable for use on asphalt, concrete, mineral felt or PVC sheet covered roofs.

The unique hinged base foot enables the guardrail to be quickly and easily lifted into place when work is being carried out, then simply folded back down again when the work is completed.

## Compliance

- EN 13374 Class A / EN ISO 14122 Part 3
- BS 13700

## Features & Benefits

- Collapsible collective protection system
- Base fitting can only pivot in one direction
- System can be raised and lowered in sections
- Recycled PVC feet do not penetrate the roof's membrane
- Wind loading in accordance with AS/NZS 1170.2

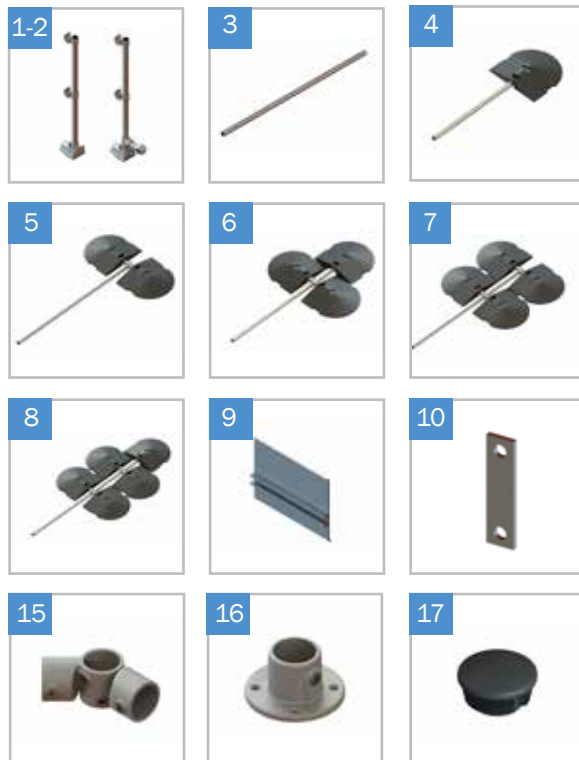

No.	Part Name	Part Code
<b>KEEGUARD FOLDSHIELD - UPRIGHTS</b>		
1	Upright Assembly	KFU1
2	Upright Assembly With Prop	KFU2
<b>STEEL TUBE</b>		
3	Rail Tube - sold per m (Typically sold 6.4m or 3.2m)	8-6-G
<b>COUNTER-BALANCE ASSEMBLIES</b>		
4	Intermediate Counterbalance Weight Assembly	CB1P
5	End Counterbalance Assemblies	CB2P
6	End Counterbalance Assemblies	CB3P
7	End Counterbalance Assemblies	CB4P
8	End Counterbalance Assemblies	CB5P
<b>KEEGUARD - TOE-BOARD</b>		
9	Toe Board (Typically sold 6m)	TB150
10	Straight Connector	TB2
11	Right Angle Connector	TB2C
12	Fixing Pack	TBFP1
<b>KEE KLAMP - COMMON FITTINGS</b>		
13	Straight Coupling	14-8
14	Elbow	15-8
15	Adjustable Side Outlet Tee	19-88
16	Wall Flange	61-8
17	Plastic Cap	77-8
18	Adjustable Elbow	BC53-88
19	D-Return	DRET
20	Ladder Clamp	SL109C
<b>KEEGUARD - ELASTOMERIC PADS</b>		
21	400 x 300 x 5 For KGU Mineral Felt	K435
22	400 x 300 x 10 For KGU Asphalt	K4310
23	500 x 500 x 10 For 440 Asphalt	K5510
24	500 x 500 x 5 For 440 Mineral Felt	K5505



**KeeGuard<sup>®</sup>  
Ladder Kit**



**ROOF TOP  
LADDER  
ACCESS**

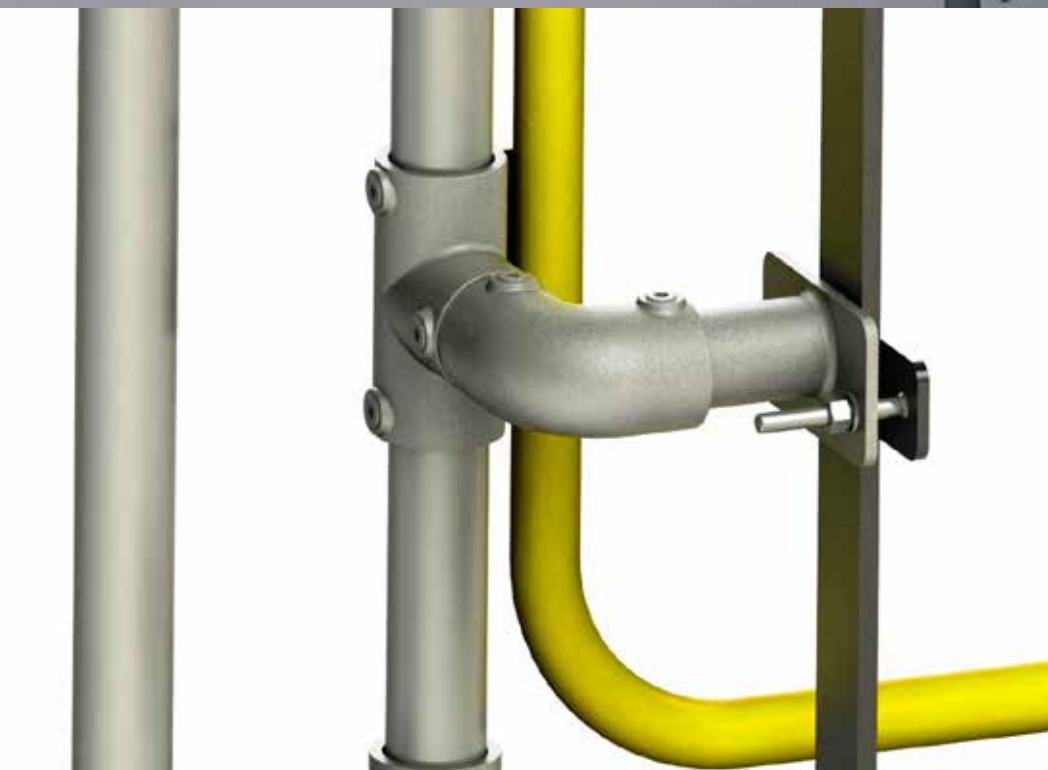



# Guardrail Kit for Roof Top Ladders

## Key Features

KEEGUARD Ladder Kit provides permanently fixed guardrail either side of an existing fixed ladder and a self-closing swing gate, permitting safe roof access for the purpose of inspection or maintenance work on roofs.

The kit has been designed specifically to provide a 'retro-fit' solution to existing cat/fixed ladders and has been independently tested & CE approved to BS EN 14122-4. Fixing is quick and easy; the kit has been developed to simply clamp on to the existing ladder. The unique fitting, which connects the guardrail to the ladder, has been designed to clamp around both flat and tubular stringers with a maximum diameter/width of 75mm.

## Compliance

- BS EN 14122-4

## Features & Benefits

- Permanently fixed guardrail either side of an existing fixed ladder with a self-closing swing gate
- Provides safe access to roofs from fixed ladders and prevents falls down either side of the ladder
- Counter balanced system so no damage to the roof membrane or building structure
- Can be "retro-fitted" to existing fixed ladders/ cat ladders
- Easily clamps to most types of ladders

No.	Part Name	Part Code
	<b>KEEGUARD LADDER KIT</b>	
1	Ladder Gate Kit - Galvanised Gate	KLKGV
	Ladder Gate Kit - Powder Coated Gate	KLKPC



More options available. Please call us on 01384 632 188 or email [sales@keesafety.com](mailto:sales@keesafety.com)



**Kee<sup>®</sup>  
Dome**



The safety  
solution for  
**SKYLIGHTS**



# Skylight Fall Protection

## Key Features

KEE DOME is a modular system designed specifically to prevent falls through skylights. Recycled PVC bases lock the posts into position around the perimeter of the rooflight. KEE KLAMP fittings and standard length tubes (1.5, 2.0 & 3.2m) are used to construct a rigid frame around the skylight.

Where building aesthetics are a concern, the KEE DOME MINI provides a less obtrusive solution due to its reduced size. This product can be used on skylights from 1.2m x 1.2m up to 1.8m x 1.8m. This version features smaller recycled PVC bases, tubes and fittings to construct a rigid frame around the rooflight.

No.	Part Name	Part Code
<b>KEE DOME KITS</b>		
1	KEE DOME Hatch Guard With Gate 1.5m Max x 3.2m Max	KDH1
2	KEE DOME Smoke Extractor Guard 1.5m Max x 3.2m Max	KDH2
3	KEE DOME Hatch Guard Short With Gate 2.0m x 1.5m	KDH3
4	KEE DOME KWIK KIT For 2.0m x 2.0m	KDK2
5	KEE DOME KWIK KIT For 2.0m x 3.2m	KDK3
<b>KEE DOME - MINI</b>		
6	KEE DOME Mini KWIK KIT 1.2m x 1.2m	KDK4
7	KEE DOME Mini KWIK KIT 1.8m x 1.8m	KDK5

## Compliance

- EN ISO 14122 Part 3

## Features & Benefits

- Minimise the risk of falling through glazed areas or open hatches
- Recycled PVC feet do not penetrate the roof membrane
- Suitable for use on all roof surfaces with a maximum pitch of 3°
- Rapid assembly around the designated area





**ROOFLIGHT  
PROTECTION**  
designed specifically  
for use on metal  
profile roofs

# Rooflight Protection

## Key Features

The KEE COVER range of rooflight protection has been designed specifically for use on metal profile roofs and provides effective protection without blocking the light into the building.

KEE COVER is a component based system, allowing ease of transport of components to the roof and assembly on site. Standard mesh panels are supplied 2m long by 1m wide and sit onto the metal frame which is constructed from KEE KLAMP fittings. 2m (or 1m) long by 1m wide extension panels are available for larger rooflights and skylights.

KEE COVER is available in two formats, one that sits virtually flat on the roof surface, and one that is mounted onto small legs to raise it above the rooflight or skylight.

## Compliance

- Tested to EN ISO 1873: 2014 Part 2
- Complies with the ACR Red Book

## Features & Benefits

- Adaptable solution for covering rooflights on trapezoidal and standing seam roofs
- Mesh panels do not block out light, keeping the building illuminated
- Variable height caters for different shaped roof lights
- Extension panels available for larger roof lights and skylights
- All components and mesh panels are hot dip galvanised for enhanced durability
- Frame can be colour coated for improved visibility

No.	Part Name	Part Code
1	<b>KEE COVER - STD MODULES - 1M WIDE</b>	
	KEE COVER 2 x 1m Primary Module - Std	KC21PMST1
	KEE COVER 2 x 1m Extension Module - Std	KC21XMST1
2	<b>KEE COVER - STD MODULES - 2M WIDE</b>	
	KEE COVER 1 x 2m Primary Module Wide - Std	KC12PMST2
	KEE COVER 1 x 2m Extension Module - Std	KC12XMST2
3	<b>KEE COVER - RAISED MODULES - 1M WIDE</b>	
	KEE COVER 2 X 1 Primary Module - Raised	KC21PMRA1
	KEE COVER 2 X 1 Extension Module - Raised	KC21XMRA1
4	<b>KEE COVER - RAISED MODULES - 2M WIDE</b>	
	KEE COVER 1 x 2 Primary Module - Raised	KC12PMRA2
	KEE COVER 1 X 2 Extension Module - Raised	KC21XMRA2
5	<b>KEE COVER – TRAVERSE PRIMARY</b>	
	KEE COVER 3.6m x 1m Primary Panel - Std	KC361TPST
	KEE COVER 2.4m x 1m Primary Panel - Std	KC241TPST
	KEE COVER 2m x 1m Primary Panel - Std	KC021TPST
	KEE COVER 1.5m x 1m Primary Panel - Std	KC151TPST
	KEE COVER 1.2m x 1m Primary Panel - Std	KC121TPST
6	<b>KEE COVER – TRAVERSE EXTENSION</b>	
	KEE COVER 3.6m x 1m Extension Panel - Std	KC361TEST
	KEE COVER 2.4m x 1m Extension Panel - Std	KC241TEST
	KEE COVER 2m x 1m Extension Panel - Std	KC021TEST
	KEE COVER 1.5m x 1m Extension Panel - Std	KC151TEST
	KEE COVER 1.2m x 1m Extension Panel - Std	KC121TES

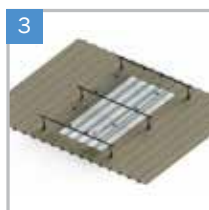



**PORTABLE  
DEADWEIGHT  
ANCHOR** device for  
use on roofs of up to  
5 degrees pitch

# Portable Deadweight Anchor

## Key Features

WEIGHTANKA, a part of the KEE ANCHOR range, is a portable deadweight anchor device for use on roofs of up to 5 degrees pitch. The system has been specifically designed to provide short term safety for low frequency operations where guardrails are not provided, such as for maintenance of flat roofs or plant and equipment installed at roof level.

The portable deadweight anchor is extremely compact, easy to assemble and weighs only 250kg, with no single item weighting greater than 25kg.

WEIGHTANKA is suitable for use on all roof surfaces including single-ply membrane, asphalt, concrete, stone chippings and mineral felt. The system provides fall protection for a single worker and fall restraint for two people when working at least 500mm away from a fall hazard.

## Compliance

- EN 795: 1997

## Features & Benefits

- Short term safety for low frequency work
- System for up to two users for restraint
- Does not penetrate the roof surface
- Compact design for ease of transportation

Type of Roof Surface	Quantity of Galvanised weights
<b>BITUMINOUS</b>	
Asphalt Total Mass - 250kg (551lb 3oz)	6
Mineral Felt Total Mass - 250kg (551lb 3oz)	6
<b>SINGLE PLY MEMBRANE</b>	
(Flat, Smooth) Total Mass - 300kg (661lb 6oz)	8
(Embossed) Total Mass - 400kg (881lb 13oz)	12
<b>LOOSE STONES (ALL LOOSE STONES TO BE BRUSHED)</b>	
On Asphalt Base Total Mass - 250Kgs	6
On Mastic Base Total Mass - 250Kg (551lb 3oz)	6
<b>CONCRETE</b>	
Total Mass - 250kg (551lb 3oz)	6
<b>STEEL CLADDING</b>	
Total Mass - 300kg (551lb 3oz)	8

No.	Part Name
<b>WEIGHTANKA</b>	
1	250Kg - WEIGHTANKA Assembly
2	300Kg - WEIGHTANKA Assembly
3	50mm EN795-A1 Anchor - Sheradized (1-off) Used only when two users are connected to the system
4	Tommy Bar for Weightanka
5	25Kg Galv Weight
6	Polywash 38mm O/D. Sealing Washer
7	P.P.E Warning Disc - Fall Arrest
8	P.P.E Warning Disc - Fall Restraint



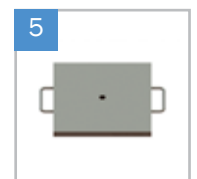
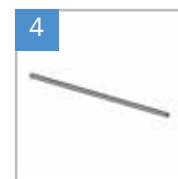

**SAFETY SIGNS** help ensure a safer environment for workers





# Safety Signs Range

## Key Features

The KEE SIGN range of safety signs helps ensure a safer environment for workers and members of the public by clearly indicating potential hazards, restricting access to dangerous areas or reminding workers of mandatory actions such as wearing safety harnesses.

The safety signs can be mounted onto most roofs thanks to a variety of fixing kit options, and can also be installed indoors. The signs themselves are made from solid, impact resistant aluminium plate with a high-quality screen printed design for maximum durability and UV resistance.

## Fixing Signs

Kee Safety's signs can be fixed using various different methods:

- An aluminium L-shaped bracket fixing pack for attaching signs to metal roofs.
- A nylon base fixing pack which can be attached to a flat roof using a suitable adhesive
- The A13 KEE KLAMP Add-on Safety Sign fitting

## Compliance

- ISO710

No.	Part Name	Part Code
<b>MANDATORY SIGNS</b>		
1	Personnel Only	SENNP1
2	No Pedestrian Access	SENNA1
<b>WARNING SIGNS</b>		
3	Danger Drop	SENDD1
4	Danger Fragile Roof	SENFR1
5	Danger Slippery Surface	SENSS1
6	Danger Trip Hazard	SENTH1
7	Harness Must Be Worn	SENHA1
8	Pedestrians Must Use This Route	SENPM1
<b>KEE KLAMP SIGN FITTING</b>		
9	KEE KLAMP Sign Fitting 42.4 O/D	A13-7
10	KEE KLAMP Sign Fitting 48.3 O/D	A13-8
<b>FIXING BRACKET</b>		
11	Aluminium L Bracket	SLBFP1
<b>PVC PLASTIC BASE</b>		
12	Nylon Base	SMBFP1

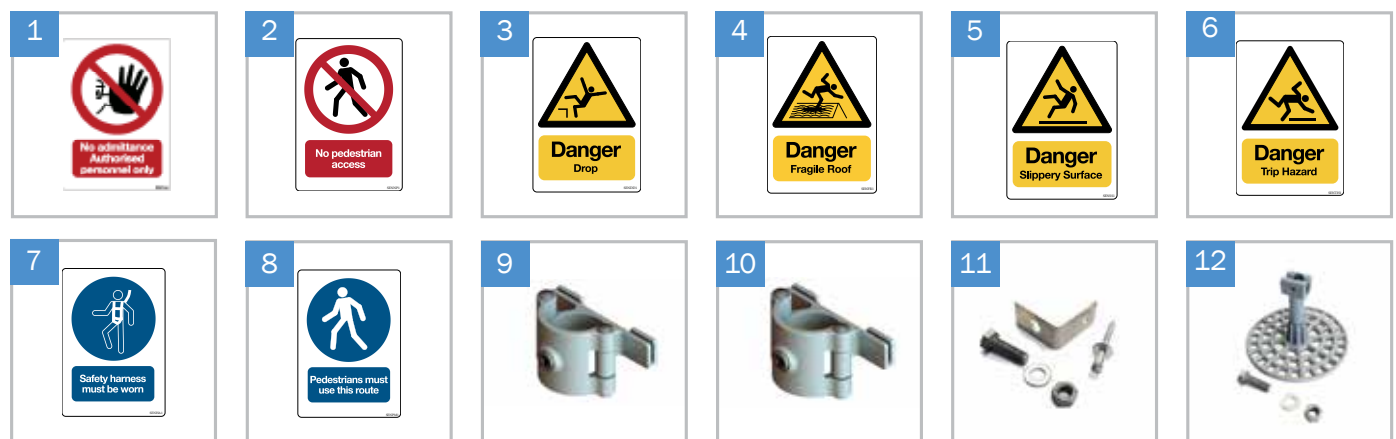

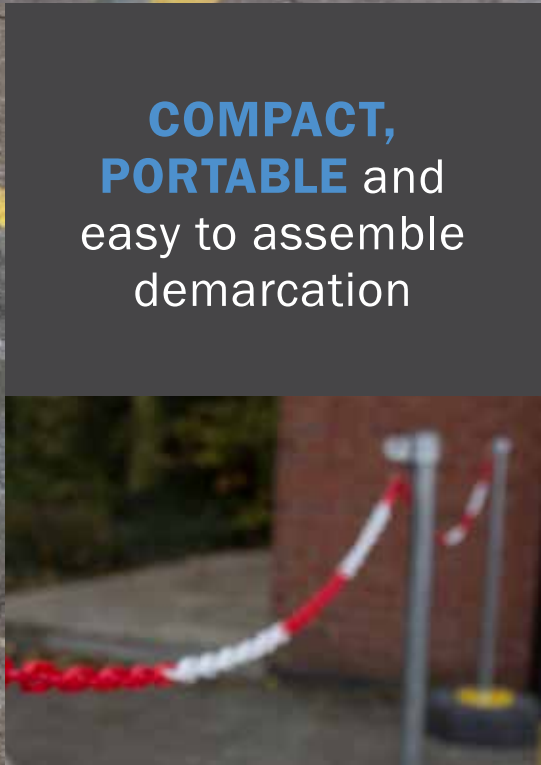

**COMPACT,**  
**PORTABLE** and  
easy to assemble  
demarcation

# Free-standing Demarcation

## Key Features

Kee Safety's high visibility, maintenance free demarcation system is ideal for providing demarcation around plant, equipment and fragile materials or as an economical solution to guardrail, providing it is placed at least 2m from the roof edge.

The system is compact making it portable and easy to assemble. The unique post design with a heavy duty PVC base weighing 25kg prevents the system from falling during severe weather conditions. Kee Safety's demarcation system is further enhanced by a high visibility, two colour, polyurethane chain which links between the support posts.

No.	Part Name	Part Code
<b>KEE MARK - UPRIGHTS</b>		
1	Kee Marcation Upright - Single Chain	KMUP1
2	Kee Marcation Upright - Twin Chain	KMUP2
<b>KEE MARK - BASE</b>		
3	Base For Kee Marcation Upright	KMBASE200
<b>KEE MARK - CHAIN</b>		
4	6mm Plastic Chain (Sold per 25m)	KMC
5	6mm Steel Chain (Sold per 100m)	KMCS

## Features & Benefits

- High visibility demarcation system
- Cost-effective
- Quick and easy to install
- Durable, maintenance free system
- Compact design provides ease of transportation and storage

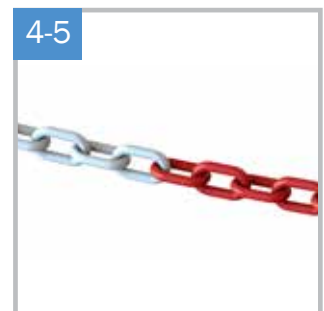

# Box Bolt®

A KEE SAFETY PRODUCT



# Blind Cavity Fixing

## Key Features

BOXBOLT is a fully tested and approved blind fixing solution for connecting in to a steel cavity, whether it be hollow section steelwork or where access is restricted to one side only. The system provides an economical solution to making blind connections, when compared with traditional methods such as welding or bolting through.

BOXBOLT is suitable for use with rectangular, square and even circular hollow sections. It is a perfect fixing solution for when installation time needs to be kept to a minimum. BOXBOLT is available in three finishes; zinc plated for the less aggressive environments, hot dip galvanized for the more aggressive environments, and stainless steel for the most demanding of applications.

## Compliance

- CE marked
- Approved for use by Lloyds Register (LR) type approval

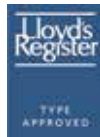

## BOXBOLT Technical Information

BOXBOLT is often used on high profile projects where the aesthetics of the building are essential. It is for this reason the BOXBOLT can be adapted to suit the requirements of the client and the architect to make the connection pleasing to the eye. The most common versions we can offer are shown here. Should you require a different style then please contact our technical department.

## Features

- No access to both sides of the connection required
- No need for close tolerance holes or tapping
- No special tools required - two spanners only
- Installation by semi-skilled labour
- Only BOXBOLT head visible when installed
- Approved for use by Lloyds Register Type and CE Mark
- Exceptional shear loading performance
- AISC and Eurocode 3 Method for designing connections
- BOXSOK rapid installation tool

## Advantages

- Connection can be made blind for connections into hollow section or where access is restricted
- New holes can be drilled quickly on-site if required
- No hire/purchase of specialist equipment or the need to move around heavy equipment
- Connections can be made much quicker without special skills or equipment
- Third party accreditation for use in tensile and shear applications
- Less BOXBOLT fixings can be used to make shear connections
- Provides a simple to follow design procedure that is the same as standard bolted connections
- Unique installation tool for speeding up installation time

## Benefits

- No through bolting or strapping required reducing fabrication work
- Flexibility and reduced on-site installation time
- Reduction in installation cost and administration
- Reduction in labour and hire costs
- Flexibility in architectural design
- Confidence that the connection will perform as stated without site proof testing required
- Flexibility in design and possible cost reductions
- Designers easily recognise the method and can save costs on competitive methods
- Reduction in on-site labour costs

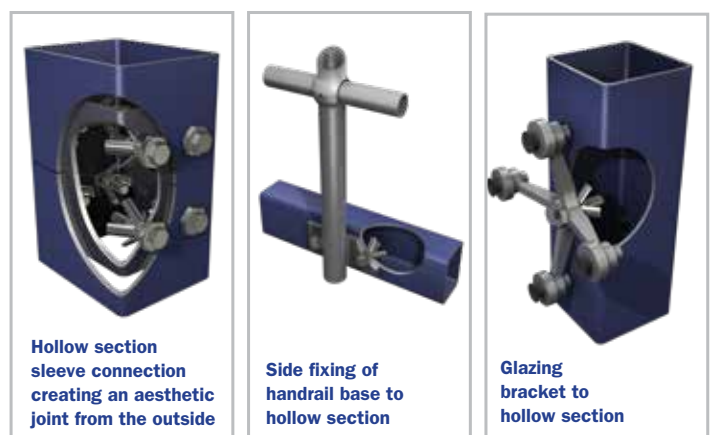
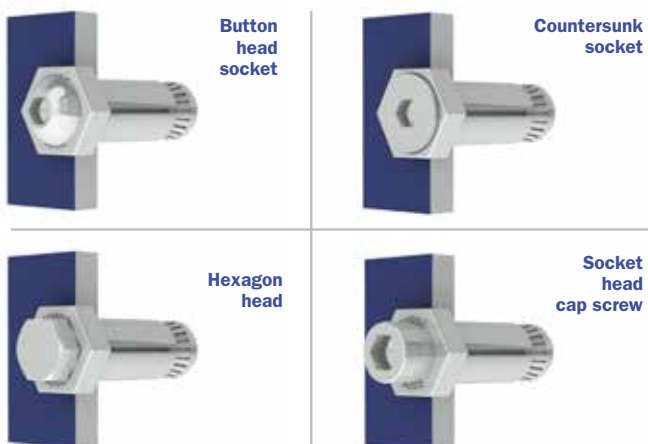

## BOXBOLT Hollow Section Fixings

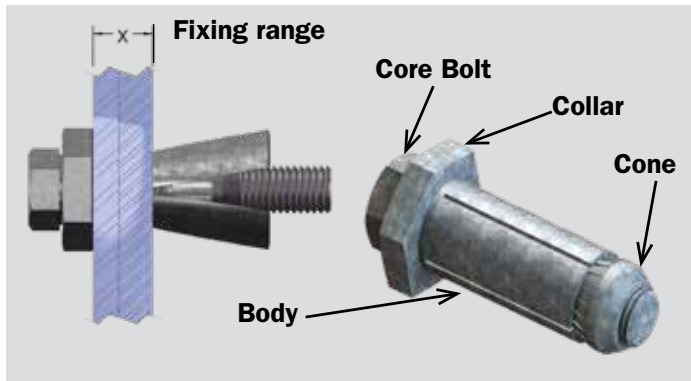

### Diameter and positioning of holes

Dia.	Dim A	Dim B	Dim C	Tolerance
M06	30	11	11	+1,00, -0,25
M08	35	13	14	+1,00, -0,25
M10	40	15	18	+1,00, -0,25
M12	50	18	20	+1,00, -0,25
M16	55	20	26	+2,00, -0,25
M20	70	25	33	+2,00, -0,25

Note: Min edge distance = Dim B plus the thickness of hollow section

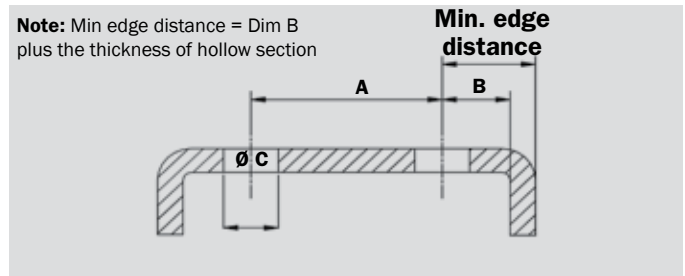

### Materials

Mild steel to **BS EN 10083** Grade **1.1151**

Stainless steel to **BS EN 10088** Grade **1.4401**

### Finishes

Zinc plated to **BS EN 12329** : Class **Fe//Zn8//A**

Hot Dip Spun Galvanised to **BS EN ISO 1461**

\* BQ1Z06 is tested at an external test house but is not approved by LR type or DIBT.

Select the type of finish you require on the **BoxBolt** by replacing the \_ in the code with a **Z** for zinc plated, a **G** for Hot Dip Galvanised or an **S** for Stainless Steel. Example: **BQ2G12** is a **M12 BoxBolt** size **2** in **Hot Dip Galvanised** Finish.

## BOXBOLT Technical Data

Part Number & description			Dimensional information							Technical		Load information			
BoxBolt	Product code	Size	Setscrew length (mm)	Fixing range (dim x)		Across Flats of collar (mm)	Collar thickness (mm)	Dim A (mm)	Dim B (mm)	Hole size (mm)	Torque (Nm)	Galvanised/ Zinc Plated		Stainless Steel	
				Min	Max							Tensile (kN)	Shear (kN)	Tensile (kN)	Shear (kN)
M06	BQ1Z06*	1	45	4	24	17	5	30	11	11 +1.0,-0.25	13	5.71	16.21	/	/
M08	BQ1_08	1	50	5	26	22	6	35	13	14 +1.0,-0.25	25	12.86	21.07	13.29	26.14
	BQ2_08	2	70	18	46	22	6	35	13	14 +1.0,-0.25	25	12.86	21.07	13.29	26.14
	BQ3_08	3	90	30	66	22	6	35	13	14 +1.0,-0.25	25	12.86	21.07	13.29	26.14
M10	BQ1_10	1	50	5	23	24	7	40	15	18 +1.0,-0.25	45	24.07	37	21.07	47.07
	BQ2_10	2	70	18	43	24	7	40	15	18 +1.0,-0.25	45	24.07	37	21.07	47.07
	BQ3_10	3	90	35	63	24	7	40	15	18 +1.0,-0.25	45	24.07	37	21.07	47.07
M12	BQ1_12	1	55	5	25	26	8	50	18	20 +1.0,-0.25	80	29.43	48.29	30.64	59.86
	BQ2_12	2	80	20	50	26	8	50	18	20 +1.0,-0.25	80	29.43	48.29	30.64	59.86
	BQ3_12	3	100	40	70	26	8	50	18	20 +1.0,-0.25	80	29.43	48.29	30.64	59.86
M16	BQ1_16	1	75	5	35	36	9	55	20	26 +2.0,-0.25	190	52.29	88.21	57.07	108.57
	BQ2_16	2	100	30	60	36	9	55	20	26 +2.0,-0.25	190	52.29	88.21	57.07	108.57
	BQ3_16	3	120	55	80	36	9	55	20	26 +2.0,-0.25	190	52.29	88.21	57.07	108.57
M20	BQ1_20	1	100	8	42	46	11	70	25	33 +2.0,-0.25	300	92	145.36	89.07	181.79
	BQ2_20	2	120	35	72	46	11	70	25	33 +2.0,-0.25	300	92	145.36	89.07	181.79
	BQ3_20	3	150	65	102	46	11	70	25	33 +2.0,-0.25	300	92	145.36	89.07	181.79

The above loads are working loads that have the following Factor of Safety (FOS) Applied: Tensile = 1.925 to 1 Shear = 1.54 to 1

The loads stated above are based on our CE Mark approval document Z-14.4-482. The loads shown above are working loads based on the rated loads factored by 1.4 which is an average value between 1.35 used for static loading and 1.5 used for live loads. The rated loads stated in our approval already have a 1.375 factor for tensile and 1.1 factor for shear applied to them. This therefore means that the above loads have a  $1.375 \times 1.4 = 1.925$  to 1 FOS in tensile and  $1.1 \times 1.4 = 1.54$  FOS in shear.

The **BoxBolt** is tested and approved by CE Mark which complies with the DIN 18800 and Eurocode 3 design methods for bolted steel connections. A design guide and calculator is available when using these methods, please ask our technical team for more information.

The **BoxBolt** is also Lloyds Register type approved for use, should you require a copy of the approval certificate our technical team will be able to assist. The strength of the material our **BoxBolt** is connecting into should be checked for structural capacity by a structural engineer.

# Help Desk

## Dedicated Account Manager

Our experienced sales team and a dedicated Account Manager strive to deliver a professional and personal service to support you and your company. The Account Manager will support your day-to-day requirements and build long-term relationships with your team.

## Unrivalled Technical Support Services

Whether it is a ground-based railing structure or a fall protection project, Kee Safety can advise you on project costs and help with specifying products. You can send us a sketch of the structure you are working on and we will detail all products you need to fulfil your client's requirements. We will also make sure that the recommended solution is compliant with current building regulations and safety requirements.

Keel Safety has CAD facilities and design software which enable us to create detailed drawings for your requirements, if needed.

## Joint Site Surveys

When you work on bigger, or more complicated projects, please contact us and we will be happy to help. If required, we can support you in carrying out a joint site survey.

- Wide range of safety products
- Expert industry knowledge
- Dedicated Account Manager
- Technical advice and support
- Quotation and specification service
- Joint site surveys if needed
- Design solutions in CAD



### Contact Kee Safety Help Desk

**Tel** 01384 632 188  
**Fax** 01384 632 192  
**Email** sales@keesafety.com



**Kee Safety Ltd**

Cradley Business Park  
Overend Road, Cradley Heath  
West Midlands, B64 7DW

T: +44 (0) 1384 632 188

F: +44 (0) 1384 632 192

E: [sales@keesafety.com](mailto:sales@keesafety.com)

[keesafety.co.uk](http://keesafety.co.uk)



KEE KLAMP, KEE LITE, KEE ACCESS, KEEGUARD, KEE DOME, KEE GATE, KEE COVER, KEE ANCHOR, WEIGHTANKA, KEE MARK, KEE WALK and KWIK KIT are trademarks of Kee Safety Limited. and BOXBOLT is a registered trademark of Access Technologies Ltd, a subsidiary of Kee Safety Group Ltd. Whilst every effort has been made to ensure the accuracy of the information contained in this brochure Kee Safety Group Ltd and/or its subsidiaries cannot be held responsible for any errors or omissions. Kee Safety Group Ltd and/or its subsidiaries reserve the right to alter or withdraw products without prior notice. Kee Safety Group Ltd and/or its subsidiaries accepts no responsibility for any loss or damage arising from improper use of their products.

©2022 Kee Safety Limited Ltd. All Rights Reserved.  
KS/DISTR\_uk\_v5\_10/22