



SEPARATING PEOPLE FROM HAZARDS

Safety Components Catalogue



- FLEXIBLE SOLUTIONS FOR ALL TYPES OF SAFETY BARRIERS AND STRUCTURES
- NO WELDING OR THREADING
- HIGH CORROSION RESISTANCE
- WIDEST PRODUCT RANGE AVAILABLE





KEE SAFETY is a leading global supplier of components and bespoke safety systems. Our systems are quick and easy to design and install, and are very cost effective due to the modularity of their parts. The principle is simple yet highly effective, proven over 75 years in thousands of completed projects across the globe.

Whether you need to separate people from hazards or protect your equipment on site, **KEE SAFETY** offers the most cost effective, flexible and safe solutions to your barrier requirements.

Safety

KEE SAFETY regularly monitors all new safety standards and directives to ensure the highest protection. Our systems not only meet but also exceed the current safety requirements and our components comply with the latest UK Building Regulations and European Standards.

Quality

Quality is the overriding priority when manufacturing **KEE SAFETY** components. Fittings are manufactured to strict specifications and TÜV certified for strength, manufacturing quality and consistency.

Solutions

From simple protection for loading bays or safety walkways in factories, to safety barriers in aggressive coastal environments or the protection of road bridges and culverts, **KEE SAFETY** provides the strategic integrated solution to give you absolute confidence in your safety requirements.



An innovative product for the construction of steel tubular structures. **KEE KLAMP** fittings are pre-galvanised cast iron for strength and corrosion resistance.



Fittings manufactured from a polished high grade aluminium alloy for the construction of lightweight tubular structures. **KEE LITE** fittings offer superior corrosion resistance, strength and durability.



A range of galvanised cast iron fittings suitable for stairs, ramps and walkways specially designed for disabled access, meeting the requirements of Building Regulations part 'M' and the Equality Act.



Contents

Technical Information	04
KEE KLAMP Components	06
KEE LITE Components	26
KEE ACCESS Components	34
Accessories	39
Safety Barrier Systems	40
Meeting Safety Standards	43
Assembly and Installation	44
Load Tables	52
Vibration Test	54



Galvanised Steel

KEE KLAMP and **KEE ACCESS** components are supplied hot dip galvanised to BS EN ISO 1461.

Powder Coating

Durable, polyester coating applied to already galvanised/polished products; available in any RAL colour.

Aluminium

KEE LITE components are made from high grade Aluminium Silicon Magnesium Alloy.

Anti-Bacterial Coating

Defence against the growth of potentially harmful invisible bacteria and fungi; this powder coating can be applied in a wide range of RAL colours.

RAL Colours

The broad colour range offers a variety of visual contrast options. These colours will enhance any handrail, guardrail, balustrade or a multitude of applications.

Tube for your Structure

KEE SAFETY components are produced in a range of standard sizes to suit steel tubing to BS EN 10255 (ISO 65), medium and heavy gauge, from 17.5mm to 60.3mm outside diameter; also equivalent sizes of tubing in other materials.

Tubing of other specifications can be used, providing the steel is compatible with BS EN 10255 (ISO 65) and wall thickness is not less than 3.2mm.

KEE KLAMP tube size	Tube diameter (mm o.d.)	Nominal bore* (mm)
3	17.5	10
4	21.3	15
5	26.9	20
6	33.7	25
7	42.4	32
8	48.3	40
9	60.3	50

*Nominal bore is an arbitrary dimension, because the bore varies with the wall thickness of the tubes.

TÜV Approval

KEE SAFETY components are approved by TÜV, Europe's leading independent testing house. The maximum load of each fitting type is as stated on the TÜV Certificate, a copy of which is available upon request. For an up-to-date TÜV listing see our website at www.keesafety.co.uk.



Note:

KEE SAFETY can provide general guidance on the use of the fittings detailed in this catalogue. However, the nature of the product means that the ultimate responsibility for selecting the correct fitting for an application rests with the customer.

The customer should also ensure that any existing structure to which a **KEE SAFETY** component is being secured is of sufficient strength to support both the weight of the **KEE SAFETY** construction and the imposed loads applied, including wind loads, snow loads and any other superimposed loads.

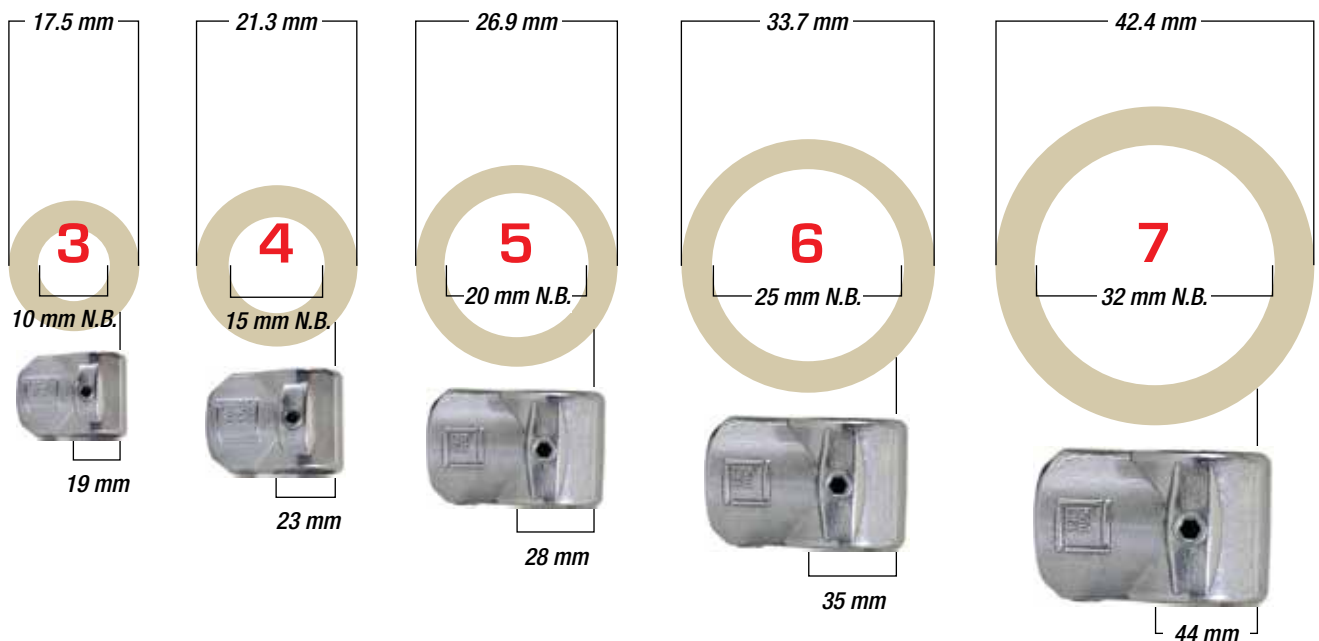

Selecting Kee Safety Components

Every fitting is illustrated and accompanied by a table of sizes and weights. Each fitting has a simple numerical code reference, which is unique and differentiates it from every other fitting. The code defines the type of fitting and the tube size or sizes it is designed to receive.

_____ component type, name and description _____

25 Three Socket Tee

Most commonly used as the 90° joint between the top rail and an intermediate upright on safety railing. As there are two socket screws in the sleeve, this fitting can be used where a join is required in the horizontal tube. The Type 10 fitting can be used as an alternative when a join in the tube is not required.

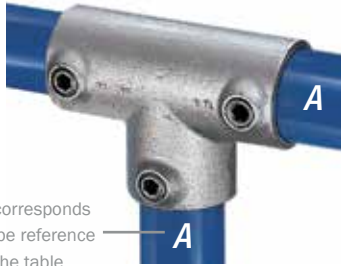

letter corresponds with tube reference in the table

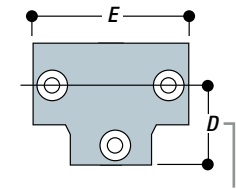

each letter in the drawing has a corresponding measurement in the table

first number preceding the dash identifies the component type

Type	Tube reference			Measurement (mm)			Weight (Kg)
	A	B	C	D	E	F	
25-4	4			34	67		0.18
25-5	5			41	82		0.37
25-6	6			46	92		0.49
25-7	7			60	120		0.85
25-8	8			68	136		1.09
25-9	9			84	168		1.74

the single digit following the dash defines the tube size. (Two digits after the dash indicate that the fitting is designed to receive two sizes of tube, and likewise with three digits.) See below for tube reference digits related to actual tube dimensions

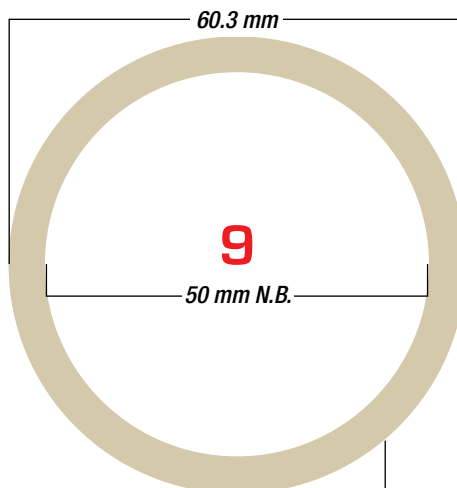
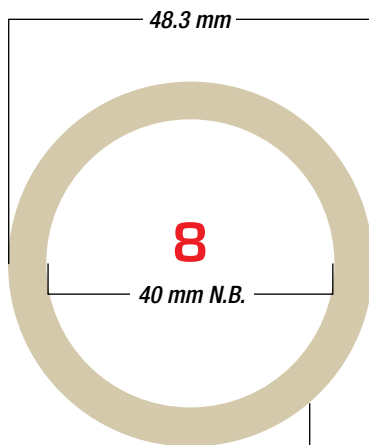

Specifying Components

05 52 00 METAL RAILINGS

PART 1-1 GENERAL

- 1.1 SCOPE
- 1.2 RELATED WORK
- 1.3 RAILING STRUCTURAL REQUIREMENTS
- 1.4 SUBMITTALS
- 1.5 QUALITY ASSURANCE

PART 2-2 PRODUCTS

2.1 SUPPLIER

- A.** Manufacturer of handrail, guardrail or railing systems shall be the following except where otherwise noted on the Drawings:

Kee Safety Limited
Cradley Business Park
Overend Road
Cradley Heath, B64 7DW
Tel. +44 (0) 1384 632 188

2.2 SYSTEMS

- A.** Handrails and Guardrails: Provide tube, **KEE KLAMP**, **KEE LITE** or **KEE ACCESS** fittings and accessories as indicated or required to match the design indicated in the Drawings.

2.3 METALS

- A.** Tube
 1. Steel Tube: BS EN 10255 (ISO 65).
 2. Aluminium Tube: BS EN 755.
- B.** Fittings and Castings
 1. Cast Iron Fittings or Castings to comply with BS EN 1562 & 1563.
 2. Hot Dip Galvanised finish to comply with BS EN ISO 1461.
 3. Aluminium Alloy Fittings or Castings conforming to A356-T6
 4. Brackets, Flanges and Anchors: Cast or formed metal of same material and finish as supported rails.

2.4 OTHER MATERIALS

2.5 FABRICATION-GENERAL

PART 3-3 EXECUTION

- 3.1 EXAMINATION AND PREPARATION
- 3.2 INSTALLATION
- 3.3 JOB CLOSE OUT

A brief three part specification for **KEE SAFETY** components is shown above for quick reference. The full specification is available for download on the **KEE SAFETY** website at www.keesafety.co.uk.

Steel tube is an inherently efficient structural component. It is strong, has no sharp corners, and is readily available worldwide. The difficulty in using steel tube to form structures arises when joining. Threaded tube must be supplied in set lengths making for zero flexibility in installation. Welding is labour intensive, requires a highly skilled workforce, and specialised equipment.

The answer is **KEE KLAMP** components. The underlying principle is simple but highly effective: use slip-on components to create versatile and rigid tubular structures. The **KEE KLAMP** principle has been developed and refined for more than 75 years resulting in an extensive range of components suited for any need.

Engineering

The engineering principle behind the **KEE KLAMP** component is the foundation of the most versatile tube connection system available. We provide the versatility needed to achieve virtually any structure configuration.

KEE KLAMP fittings are iron castings manufactured to the requirements of BS EN 1562 & 1563. We have engineered a range of components to suit seven different sizes of tube. Hexagon socket set screws firmly lock the component to the tube. Set screws are manufactured in case hardened steel and are protected against corrosion with **KEE KOAT**; alternatively, stainless steel screws are available. This, combined with the **THREDKOAT** factory applied coating for the threaded recess, ensures that tubular structures achieve longer life and better corrosion resistance.

A **KEE KLAMP** component (size 5 to 9) can support an axial load of 900Kg per set screw with the set screw tightened to a torque of 4Kgm (39 Nm or 29lbs/ft); rating includes a safety factor of 2:1. This is normally obtained when the set screw is fully tightened using a ratchet wrench.



Fittings by Function

Base Fittings

- 62.....Standard Railing
- 63.....Angle Base
- 363.....Angle Base Flange 11° - 30°
- 64.....Vertical Railing
- 65.....Horizontal Railing
- 66.....Ground
- 67.....Angle
- 68.....Wall
- 69.....Rail w/ Toe Adaptor
- 115.....Wall
- 262.....Round Flange
- 265.....Offset Rail Wall
- 316.....Parapet

Clips

- 79.....Sheeting
- 81.....Single Sided
- 82.....Double Sided
- 105.....Sheeting w/o hardware

Couplings

- 14.....Straight
- 18.....Internal
- 145.....Crossover

Crosses

- 26.....Two Socket
- A26.....Split Two Socket
- 326.....Level to Sloping Down or Up 30° - 45°
- 328.....Two Socket Cross 11° - 30°
- 30.....Adjustable 30° - 45°
- 35.....Three Socket

- A35.....Split Three Socket
- 40.....Four Socket
- A40.....Split Four Socket
- 89.....Two Socket Angle
- 91.....PGR Two Socket Cross

Crossovers

- 17.....Clamp-on
- 45.....Crossover
- A45.....Split
- 46.....Combination Socket Tee
- 121.....Corner

Elbows

- 15.....90°
- 20.....Side Outlet
- BC53.....Swivel
- 55.....Obtuse Angle
- 55A.....Variable 11° - 30°
- 56.....Acute Angle
- 56A.....Acute Angle 11° - 30°
- 87.....Angle
- 92.....PGR

- 320LH...Left hand level to Sloping Down Side 30° - 45°
- 320RH...Right hand level to Sloping Down Side 30° - 45°

Flanges

- 31.....Pallet
- C58.....Swivel
- P58.....Double Central Flange
- 59.....Spigot
- 60.....Extra Heavy

- 61.....Flange

- 70.....Rail Support

Swivel Sockets

- C50.....Single Combination
- F50.....Female Single
- M50.....Male Single
- MH50.....Male Single Horizontal
- C51.....Double
- M51.....Male Double Member
- MH51.....Male Double Horizontal Member
- C52.....Corner
- M52.....Male Corner
- C53.....Adjustable Three Way
- M53.....Variable Angle Double
- M58.....Swivel Flange Plate
- 78/83.....Gate Hinge Set

Tab Panels

- P50.....Offset Sing. w/ Slot
- P51.....Offset Double w/ Slot
- P57.....Single w/ Slot
- P57E.....Modified P57
- P58.....Double w/ CSH

Tees/Sockets

- 10.....Single Socket
- A10.....Split Single Socket
- 12.....Single Socket 45°
- A12.....Split Single Socket 45°
- 16.....Clamp-on
- 19.....Adjustable Side Outlet
- 21.....90° Side Outlet
- A21.....Split 90° Side Outlet
- 25.....Three Socket

- 327.....Three Socket 11° - 30°
- 427.....Three Socket Tee 30° - 45°
- 29.....Single Socket 30° - 60°
- 329.....Single Socket Tee 11° - 30°
- 46.....Combination Crossover
- 86.....Angle
- 88.....Three Socket Angle
- 90.....PGR Three Socket
- 93.....Pedestrian Guard Rail
- 114.....Swivel
- 321 LH...Left hand level to Sloping Down Side Outlet 30° - 45°
- 321 RH...Right hand level to Sloping Down Side Outlet 30° - 45°
- 325.....Level to Sloping Down 30° - 45°
- 325A.....Level to Sloping Up 30° - 45°

Plugs

- 77.....Plastic
- 84.....Malleable

Miscellaneous

- 71.....Weather Cap
- 72.....Stair Tread Support
- 75.....Collar
- 76.....Hook
- 95.....PGR Internal Spigot
- 97.....Set Screw
- 99.....Hex Key
- 100.....Plastic Set Screw Caps
- S115.....Packer Plate for Type 115
- 118.....Rose Cover
- 350.....Eaves Fitting
- 351.....Ridge Fitting

10 Single Socket Tee

Designed to give a 90° perpendicular joint between two tubes most commonly where the middle rail of a guardrail meets an end upright where the guardrailing is flat and level. Also used for base ties on racking. This fitting cannot be used to join tube; a Type 25 should be used when a join in the tube is necessary.

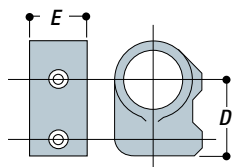
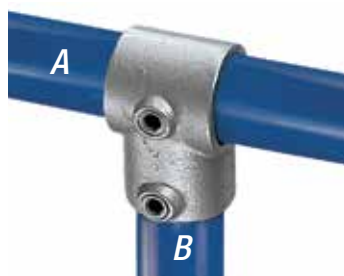

TYPE	Tube ref.		mm		Kg
	A	B	D	E	
10-3	3	3	29	25	0.07
10-4	4	4	34	32	0.13
10-5	5	5	41	37	0.19
10-6	6	6	46	47	0.29
10-65	6	5	44	37	0.25
10-67	6	7	55	55	0.43
10-7	7	7	60	55	0.45
10-75	7	5	57	37	0.32
10-76	7	6	57	46	0.39
10-78	7	8	73	60	0.63
10-8	8	8	68	60	0.53
10-87	8	7	63	55	0.50
10-9	9	9	84	73	0.97
10-98	9	8	74	64	0.65

12 Single Socket Tee (45°)

Engineered to create 45° angles. This component is most frequently used for bracing and struts.

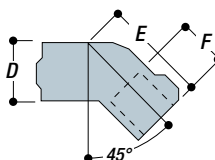

TYPE	Tube ref.	mm			Kg
	A	D	E	F	
12-5	5	35	72	35	0.30
12-6	6	44	85	35	0.43
12-7	7	55	94	40	0.63
12-8	8	60	108	40	0.77

A12 Split Single Socket Tee (45°)

The unique hinge and pin system of this fitting enables existing structures to be easily extended without the need for dismantling. This fitting is most frequently used for bracing and struts.

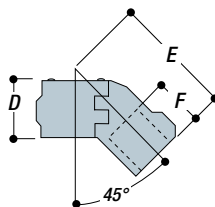
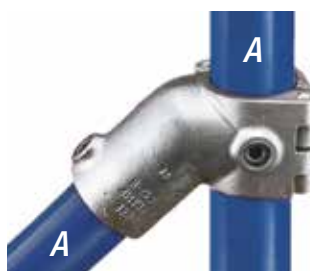

TYPE	Tube ref.	mm			Kg
	A	D	E	F	
A12-8	8	60	122	52	0.77

A10 Split Single Socket Tee

Designed to allow additions or extensions to existing structures without the need for dismantling. Tube must not be joined within the fitting. Fitting has strength and function comparable to Type 10 components.

Note: The A10-8 differs from the picture because it uses parts of the A21/A26 fittings to form it.

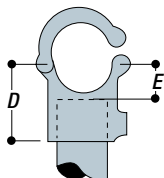
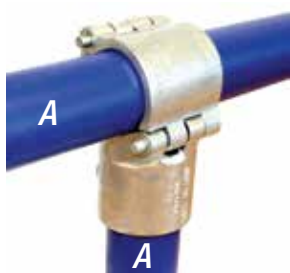

TYPE	Tube ref.	mm		Kg
	A	D	E	
A10-7	7	60	28	0.57
A10-8	8	88	33	0.89

14 Straight Coupling

Designed to form an in-line joint between two pieces of tube of the same size. Where a constant diameter is required along the outside of the tube (such as disabled access handrail or garment storage) an internal spigot (Type 18) should be considered.

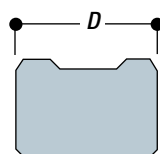

TYPE	Tube ref.	mm	Kg
	A	D	
14-4	4	58	0.14
14-5	5	77	0.23
14-6	6	89	0.39
14-7	7	102	0.52
14-8	8	104	0.57
14-9	9	124	1.08

15 Elbow (90°)

A 90° elbow joint, most frequently used as an end joint for the top rail of safety railing on a level site.

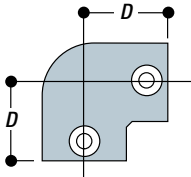
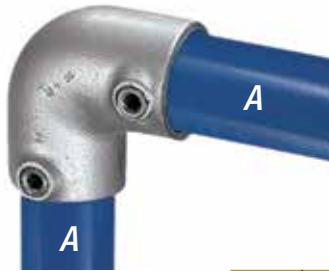

TYPE	Tube ref.		mm		Kg
	A	D	D		
15-4	4		34		0.13
15-5	5		41		0.27
15-6	6		46		0.37
15-7	7		60		0.52
15-8	8		68		0.77
15-9	9		85		1.28

18 Internal Coupling

An internal spigot providing a flush joint between two tubes of the same diameter. Not as strong as Type 14 and must not be used where a direct tensile load is applied. This fitting can only be used with 3.2mm thick tube.



Note: This fitting can only be used with tube wall thickness 3.2 mm



WARNING: Type 18 coupling must not be used as a load bearing joint.

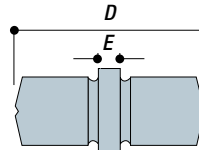

TYPE	Tube ref.		mm		Kg
	A	D	E		
18-6	6	76	20		0.18
18-7	7	76	20		0.27
18-8	8	76	20		0.35

16 Clamp-on Tee

Widely used for adding to and modifying existing structures. This performs the same function as a Type 10, but because of its open socket, it can be added to a complete structure. For alternative fitting, see Type A10. The hex head bolt is for retaining purposes only. Torqued up to 15Nm.

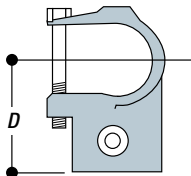
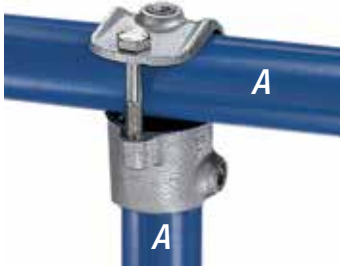

TYPE	Tube ref.		mm		Kg
	A	D	D		
16-5	5		50		0.29
16-6	6		53		0.45
16-7	7		67		0.59
16-8	8		77		0.81
16-9	9		90		0.98

19 Adjustable Side Outlet Tee

Used in pairs to form variable angle joints between 90° and 180°. When calculating cutting lengths for tube, dimension 'E' should be subtracted to give true tube length. N.B. Type 19-85 can produce an angle range between 60° and 180°.



Note: Pairs sold and priced separately in UK, France, and Germany.

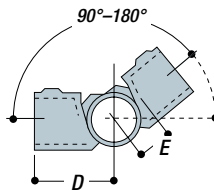

TYPE	Tube ref.		mm		Kg
	A	B	D	E	
19-5	5	5	60	31	0.20
19-6	6	6	58	33	0.29
19-7	7	7	73	40	0.41
19-8	8	8	90	55	0.53
19-85	8	8	90	55	0.65
19-8T	8	8	90	59	0.64
19-9	9	9	110	49	0.92

17 Clamp-on Crossover

Designed to provide a 90° crossover joint. Can be added to an existing structure. Tube should not be joined within this fitting. For an alternative fitting, see Type 45 or Type A45.

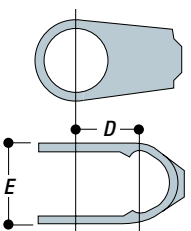
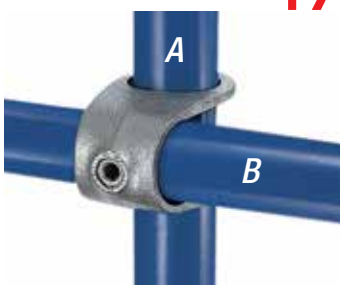

TYPE	Tube ref.		mm		Kg
	A	B	D	E	
17-5	5		27	40	0.15
17-6	6		34	48	0.33
17-7	7		43	58	0.43
17-8	8		49	65	0.70
17-9	9		61	78	0.90

20 Side Outlet Elbow

A 90° corner joint most frequently used for the top rail of safety railing. It can also be considered for the corner joint of benches, work tables, and other rectangular structures.

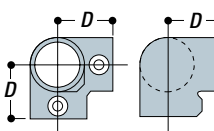
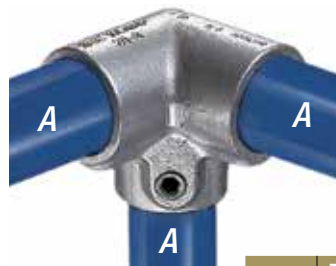

TYPE	Tube ref.		mm		Kg
	A	D	D		
20-4	4		34		0.26
20-5	5		41		0.38
20-6	6		46		0.48
20-7	7		60		0.70
20-8	8		68		0.99
20-9	9		84		1.82

21 Side Outlet Tee (90°)

Most frequently paired with Type 20 to give a 90° corner joint for the middle rail of safety railing and other rectangular structures. The upright passes through the fitting.

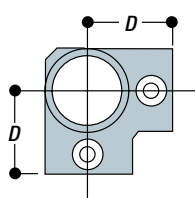
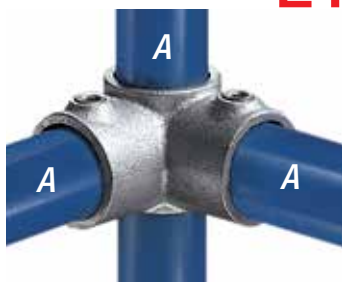

TYPE	Tube ref.		mm		Kg
	A	B	D	E	
21-4	4		34		0.14
21-5	5		41		0.28
21-6	6		46		0.41
21-7	7		60		0.55
21-8	8		68		0.73
21-9	9		85		1.36

26 Two Socket Cross

Usually paired with Type 25 to give a 90° joint between the middle rail and an intermediate upright on safety railing. The upright passes through the fitting.

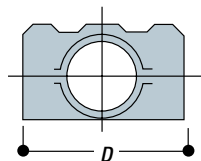
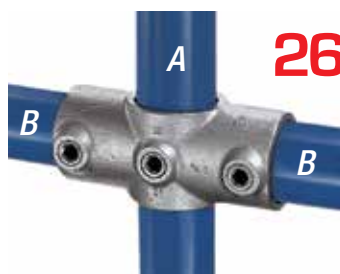

TYPE	Tube ref.		mm		Kg
	A	B	D	E	
26-4	4	4	68		0.13
26-5	5	5	81		0.27
26-6	6	6	92		0.40
26-7	7	7	120		0.65
26-8	8	8	136		0.71
26-87	8	7	126		0.67
26-9	9	9	172		1.46

A21/A26 Split Two Socket Cross/Side Outlet Tee (90°)

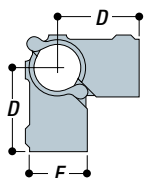
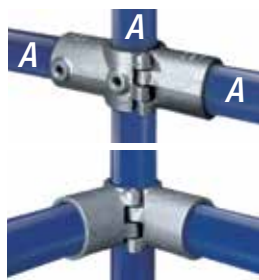

This fitting performs the same function as either Type 21 or Type 26, but because of its unique hinge and pin system, it can be added to an existing tubular assembly. Type A21/A26 fittings are supplied and priced as a kit including two casting and two taper pins, which can be assembled in either configuration.

TYPE	Tube ref.		mm		Kg
	A	B	D	E	
A21/A26-8	8		88	60	1.17

327 Three Socket Tee (11°-30°)

This fitting is used on Safety Railing with slopes between 11°-30° and fixes the top rail to a vertical intermediate upright.

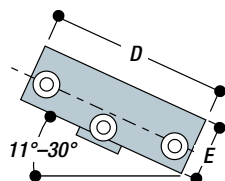
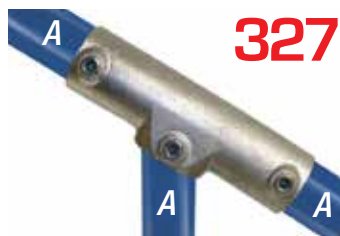

TYPE	Tube ref.		mm		Kg
	A	B	D	E	
327-7	7		180	35	1.10
327-8	8		216	40	1.40

25 Three Socket Tee

Most commonly used as the 90° joint between the top rail and an intermediate upright on safety railing. As there are two socket set screws in the sleeve, this fitting can be used where a joint is required in the horizontal tube. The Type 10 fitting can be used as an alternative when a joint in the tube is not required.

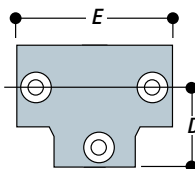

TYPE	Tube ref.		mm		Kg
	A	B	D	E	
25-4	4		34	67	0.18
25-5	5		41	82	0.37
25-6	6		46	92	0.49
25-7	7		60	120	0.85
25-8	8		68	136	0.98
25-9	9		84	168	1.57

427 Three Socket Tee (30°-45°)

This fitting is used on a safety railing with slopes between 30° and 45° and fixes the top rail to a vertical intermediate upright.

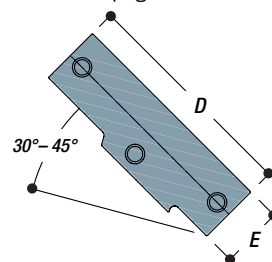

TYPE	Tube ref.		mm		Kg
	A	B	D	E	
427-7	7		180	55	0.95
427-8	8		216	60	1.22

328 Two Socket Cross (11°–30°)

This fittings is used on Safety Railing with slopes between 11°–30° and fixes the mid rail to a vertical intermediate upright.

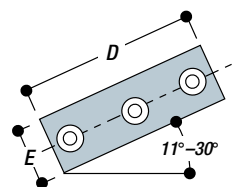
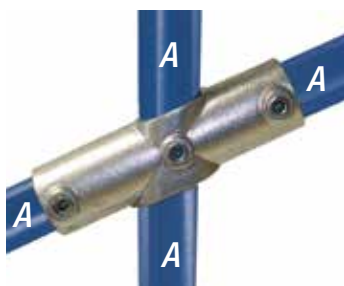

TYPE	Tube ref. A	mm		Kg
		D	E	
328-7	7	180	55	1.07
328-8	8	216	60	1.20

30 Adjustable Cross (30°–45°)

This adjustable fitting can be used for railing on staircases between the mid-rail and an intermediate upright which is required to remain vertical. It may be used at any selected angle between 30° and 45°.

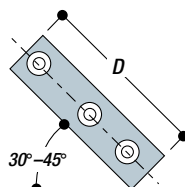

TYPE	Tube ref. A	mm		Kg
		D	E	
30-6	6	146		0.64
30-7	7	178		0.97
30-8	8	216		1.30

29 Single Socket Tee (30°–60°)

Designed as an alternative to Type 12, this adjustable fitting is most frequently used for bracing and struts. It may be used at any selected angle between 30° and 60°. See diagram on page 45.

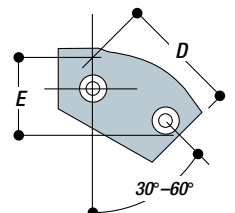
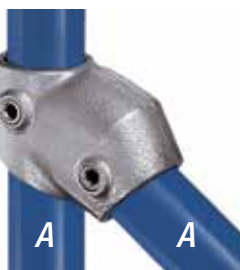

TYPE	Tube ref. A	mm		Kg
		D	E	
29-6	6	73	64	0.44
29-7	7	89	74	0.63
29-8	8	102	68	0.71

31 Pallet Flange

This fitting has been designed for the construction of post pallets. Incorporates sockets for the upright and side tubes, and a locating bell for stacking pallets. (Special order only.)

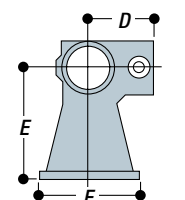

TYPE	Tube ref. A	mm			Kg
		D	E	F	
31-8	8	76	127	115	1.80

329 Single Socket Tee (11°–30°)

Designed as an alternative to Type 12, this adjustable fitting is most frequently used for bracing and struts and for terminating the mid-rail on sloping guardrails into the end upright. It may be used at any selected angle between 11° and 30°.

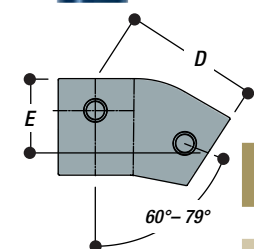
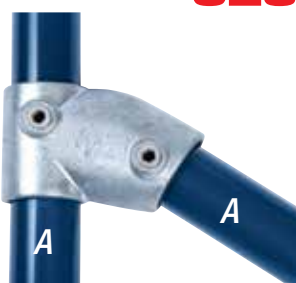

TYPE	Tube ref. A	mm		Kg
		D	E	
329-7	7	99	54	0.73
329-8	8	109	59	0.86

35 Three Socket Cross

Most frequently used to tie uprights with horizontal tubes in three directions, all at 90° to the upright. The upright passes through the fitting.

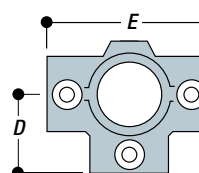
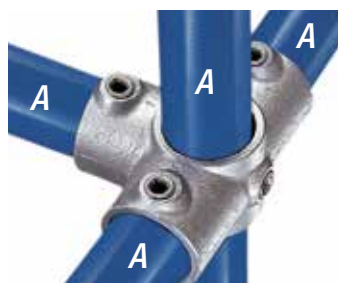

TYPE	Tube ref. A	mm		Kg
		D	E	
35-4	4	34	67	0.20
35-5	5	41	82	0.35
35-6	6	46	92	0.45
35-7	7	60	120	0.77
35-8	8	68	136	0.93
35-9	9	85	170	1.68

A35 Split Three Socket Cross

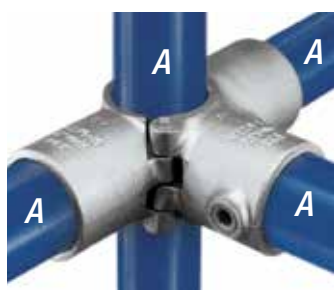

The unique hinge and pin system of this fitting enables existing structures to be easily extended without the need for dismantling. This fitting has been designed to tie an upright with horizontal tubes in three directions, all at 90° to the upright. The upright passes through the fitting.

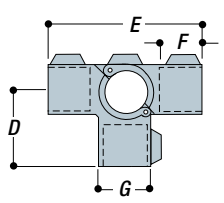

TYPE	Tube ref.	mm				Kg
		A	D	E	F	
A35-8	8	88	176	55	60	1.57

45 Crossover

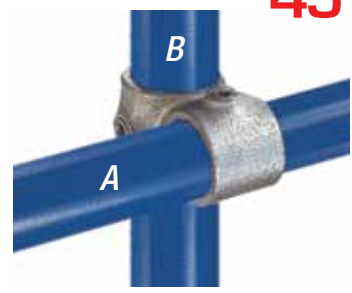

Designed to give a 90° crossover joint. Frequently used on safety railing where, to reduce cost by minimising the tube cuts, a continuous horizontal rail is used. Tube cannot be joined within this fitting. It may also be used to give intermediate levels on racks, etc. when horizontal ties between uprights are not required.

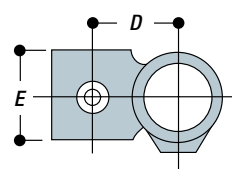

Note: Where dimension 'E' indicates two figures, the first figure refers to socket 'A' and the second refers to socket 'B' in the table.

TYPE	Tube ref.		mm			Kg
	A	B	D	E		
45-3	3	3	21	25	-	0.07
45-4	4	4	25	28	-	0.15
45-5	5	5	34	31	-	0.20
45-6	6	6	40	38	-	0.34
45-65	6	5	36	41	37	0.29
45-7	7	7	55	46	-	0.48
45-76	7	6	45	46	38	0.45
45-8	8	8	55	50	-	0.59
45-86	8	6	48	51	38	0.45
45-87	8	7	51	51	46	0.55
45-9	9	9	67	61	-	0.91
45-98	9	8	60	75	73	1.09

40 Four Socket Cross

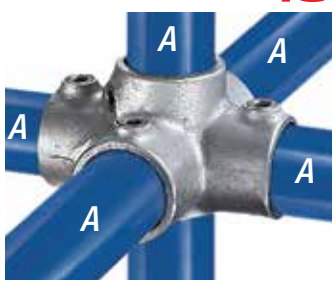

Most frequently used in multiple upright structures to tie a centre upright with horizontal tubes in four directions. The upright passes through the fitting.

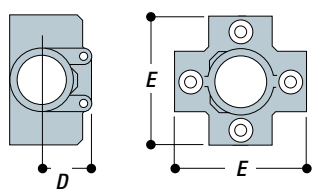

TYPE	Tube ref.	mm		Kg
		A	D	
40-4	4	34	67	0.27
40-5	5	32	82	0.40
40-6	6	37	92	1.01
40-7	7	43	120	1.29
40-8	8	53	136	1.90
40-9	9	62	168	2.04

A45 Split Crossover

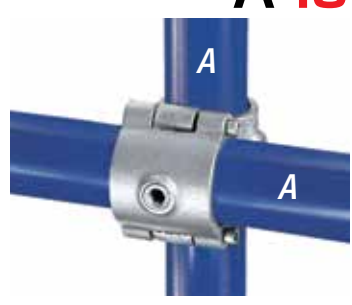

The unique hinge and pin system of this fitting enables existing structures to be easily extended without the need for dismantling. This fitting is designed to give a 90° offset crossover joint. Tube should not be joined within the fitting. Type A45 function is comparable to Type 45 fitting.

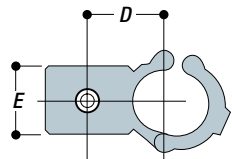

TYPE	Tube ref.	mm		Kg
		A	E	
A45-7	7	49	46	0.65
A45-8	8	55	50	0.79

A40 Split Four Socket Cross

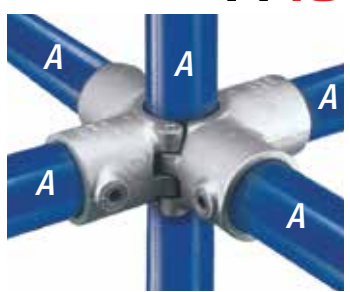

The unique hinge and pin system of this fitting enables existing structures to be easily extended without the need for dismantling. This fitting is most frequently used in multiple upright structures to tie a centre upright with horizontal tubes in four directions. The upright passes through the fitting.

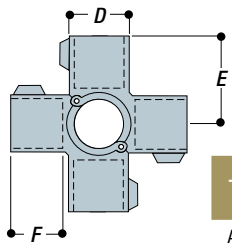

TYPE	Tube ref.	mm			Kg
		D	E	F	
A40-8	8	60	88	55	1.82

46 Combination Socket Tee and Crossover

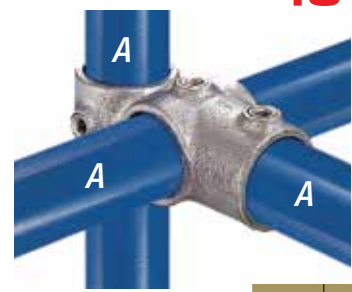

Used on racking to join horizontal carrying rails to the upright, leaving the socket to take a horizontal tie across the section. For shelved racking it is usual to have the horizontal tube outside the upright. On pallet racking it is preferable to have the carrying rails inside the upright.

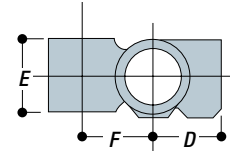

TYPE	Tube ref.	mm			Kg
		D	E	F	
46-4	4	34	28	25	0.15
46-5	5	41	31	34	0.30
46-6	6	46	38	40	0.49
46-7	7	60	46	49	0.69
46-8	8	68	51	55	0.91
46-9	9	85	61	67	1.37

Swivel Fittings

Types F50, M50, MH50, M51, MH51, M52, M53 and M58 are known as swivel fittings and can be assembled as Types C50, CH50, C51, C52, C53 and C58, or supplied as separate items. They are frequently used for bracing but can also overcome problems where joints are required at angles other than those achieved by fixed angle fittings. For economical use of tubing, when making 'C' fittings, or combination fittings, Types F50 (sizes 5 to 9 only) can be combined with different sizes of Types M50, MH50, M51, MH51, M52, M53 and M58. F50-4 and M50-4 will only combine with each other. **WARNING: An entire structure should not be constructed from swivel fittings, as they would not provide sufficient stability or rigidity in the structure.** Types M50, MH50, M51, M52, M53 and M58 can also be used separately to secure various types of in-fill panel. These fittings are not designed to take bending moments.

M50 Male Single Swivel Socket Member



One part of combination fitting C50. This can also be used for attaching flat panels to tubular structures. \emptyset indicates the diameter of the fixing hole.

Note: Type M50-4 will only mate with a Type F50-4.

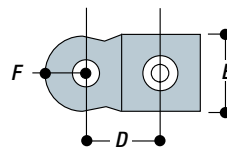

TYPE	Tube ref.	mm				Kg
		A	D	E	F	
M50-4	4	28	20	11	6.5	0.06
M50-5	5	40	38	19	10	0.24
M50-6	6	43	38	19	10	0.27
M50-7	7	48	38	19	10	0.36
M50-8	8	54	47	19	10	0.36
M50-9	9	62	45	19	10	0.54

C50 Single Swivel Socket

Complete combination fitting. Reducing combinations of Type C50 are available for sizes 5 to 9. See Types F50 and M50 for individual fitting specifications. See 'Swivel Fittings' at bottom of this page for more information.

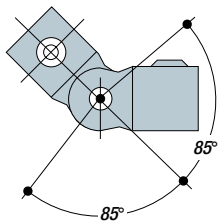
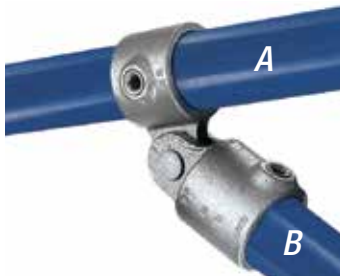

TYPE	Tube ref.		Kg
	A	B	
C50-44	4	4	0.15
C50-55	5	5	0.56
C50-66	6	6	0.64
C50-77	7	7	0.80
C50-88	8	8	0.91
C50-99	9	9	1.22

MH50 Male Single Horizontal Swivel Socket Member

This fitting can be used for attaching flat panels to tubular structures. Specially designed for retail shelving applications. Can also be used as part of a Type CH50 combination fitting. \emptyset indicates the diameter of the fixing hole.

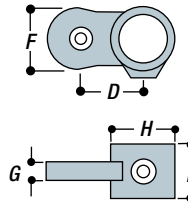

TYPE	Tube ref.	mm						Kg
		A	D	E	F	G	H	
MH50-6	6	43	38	38	11	46	10	0.30

F50 Female Single Swivel Socket Member

One part of combination fitting C50. The Type F50 in size 4 has only one ear, while Type F50 in sizes 5 to 9 has two ears. \emptyset indicates the diameter of the fixing hole.

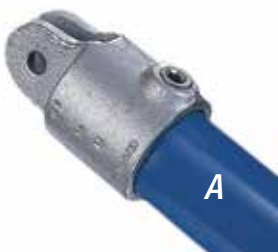

Note: Type F50-4 will only mate with a Type M50-4.

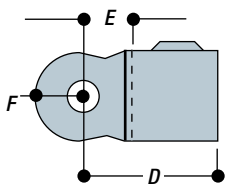

TYPE	Tube ref.	mm				Kg
		A	D	E	F	
F50-4	4	38	14	11	6.5	0.07
F50-5	5	60	25	19	10	0.28
F50-6	6	60	21	19	10	0.34
F50-7	7	68	21	19	10	0.42
F50-8	8	76	25	19	10	0.52
F50-9	9	83	21	19	10	0.65

P50 Modified M50-8 with Offset Slot

Designed for the securing of various types of panels and flooring to tube structures (i.e. plywood, plastic sheeting, wood planking, etc.). This fitting has one offset flange to allow the flush attachment of panels to tube. Often used with Type P51. See also Type P57.

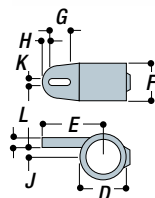

TYPE	Tube ref.	mm								Kg
		A	D	E	F	G	H	J	K	
P50-8	8	61	80	47	32	8	10	11	13	0.48

C51 Double Swivel Socket

Complete combination fitting. Type C51 is made by combining two Type F50 fittings and one Type M51. For dimensions refer to Type F50 and Type M51. See 'Swivel Fittings' on page 12 for more information.

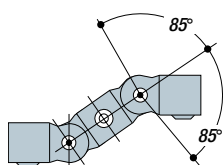
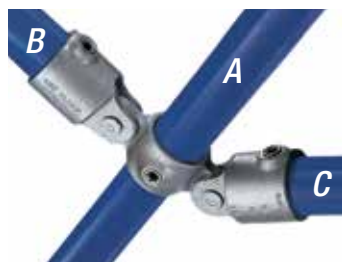

TYPE	Tube ref.			Kg
	A	B	C	
C51-555	5	5	5	0.87
C51-666	6	6	6	1.11
C51-777	7	7	7	1.35
C51-888	8	8	8	1.57
C51-999	9	9	9	2.06

P51 Modified M51-8 with Offset Slots

Designed for the secure fitting of various types of panels and flooring to tube structures (i.e. plywood, plastic sheeting, wood planking, etc.) This fitting has two offset flanges to allow the flush attachment of panels to tube.

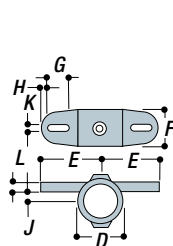

TYPE	Tube ref.	mm								Kg
		A	D	E	F	G	H	J	K	
P51-8	8	61	81	47	32	8	10	11	13	0.59

M51 Male Double Swivel Socket Member

One part of a Type C51 combination fitting. This fitting can also be used for attaching flat panels to tubular structures. \emptyset indicates the diameter of the fixing hole.

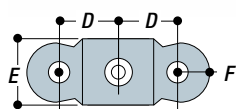
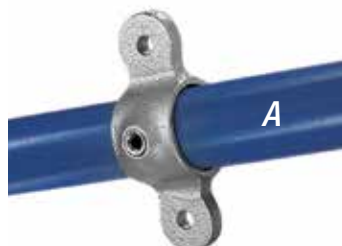

TYPE	Tube ref.	mm				Kg
		A	D	E	F	
M51-5	5	40	38	19	10	0.33
M51-6	6	43	38	19	10	0.38
M51-7	7	48	45	19	10	0.46
M51-8	8	54	45	19	10	0.48
M51-9	9	62	52	19	10	0.71

C52 Corner Swivel Socket

Complete combination fitting. Reducing combinations of Type C52 are available sizes 5 to 8. For dimensions refer to Type F50 and Type M52. See 'Swivel Fittings' (top of page 12) for more information.

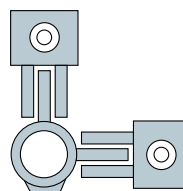
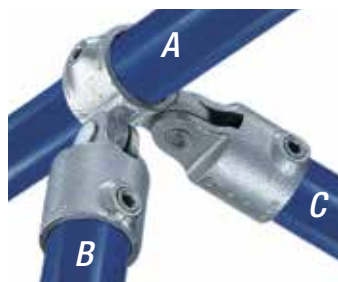

TYPE	Tube ref.			Kg
	A	B	C	
C52-555	5	5	5	0.97
C52-666	6	6	6	1.12
C52-777	7	7	7	1.34
C52-888	8	8	8	1.55

MH51 Male Double Horizontal Swivel Socket Member

This fitting can be used for attaching flat panels to tubular structures. Specially designed for retail shelving applications, the MH51 can be used as part of a CH51 combination fitting. \emptyset indicates the diameter of the fixing hole.

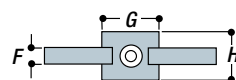
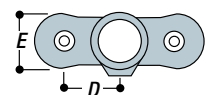

TYPE	Tube ref.	mm						Kg
		A	D	E	F	G	H	
MH51-6	6	43	38	11	46	38	10	0.44

M52 Male Corner Swivel Socket Member

One part of a Type C52 combination fitting. This can also be used for attaching flat panels to tubular structures. \emptyset indicates the diameter of the fixing hole.

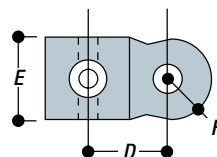

TYPE	Tube ref.	mm				Kg
		A	D	E	F	
M52-5	5	40	38	19	10	0.37
M52-6	6	43	38	19	10	0.39
M52-7	7	50	45	19	10	0.45
M52-8	8	54	47	19	10	0.46

BC53 Swivel Elbow

Type BC53 fitting has been designed as a variable angle in-line connection, adjustable through 202°.



WARNING! An entire structure should not be constructed from Type BC53-88 or any other swivel fitting, as these would not provide sufficient stability or rigidity in the structure due to the free rotation of the fitting.

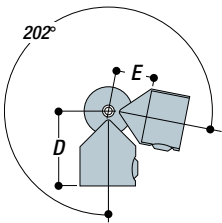

TYPE	Tube ref.	mm		Kg
	A	D	E	
BC53-66	6	60	33	0.51
BC53-77	7	73	36	0.81
BC53-88	8	83	45	1.14

55 Obtuse Angle Elbow

The Type 55 is an ideal fitting to use as an alternative to bending, or when a junction between a sloping tube and an end post is required, i.e. guardrail and staircases. (Refer to page 45 for more information.)

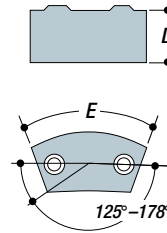

TYPE	Tube ref.	mm		Kg
	A	D	E	
55-6	6	46	116	0.51
55-7	7	55	154	0.81
55-8	8	60	153	0.85

C53 Adjustable Three Way Swivel Socket

Complete combination fitting. Type C53 is made by combining two Type M53 and two Type F50 fittings. For dimensions refer to Type F50 and type M53. See 'Swivel Fittings' on page 12 for more information. Ø indicates the diameter of the fixing hole.

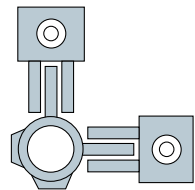

TYPE	Tube ref.	mm			Kg
	A	B	C	Ø	
C53-888	8	8	8	10.5	1.54

55A Variable Elbow (11°-30°)

The Type 55A is an ideal fitting to use as an alternative to bending or when a junction between a sloping tube and an end post is required.

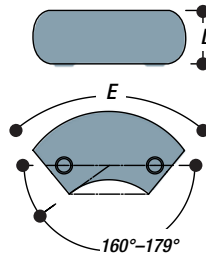

TYPE	Tube ref.	mm		Kg
	A	D	E	
55A-7	7	55	115	1.00
55A-8	8	60	150	1.28

M53 Variable Angle Double Swivel Socket Member

A part of a Type C53 combination fitting. Type C53 is made by combining two Type M53 and two Type F50 fittings. Ø indicates the diameter of the fixing hole.

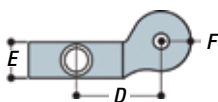
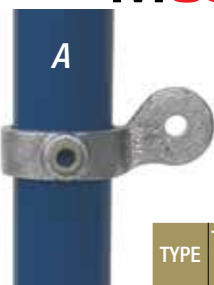

TYPE	Tube ref.	mm				Kg
	A	D	E	F	Ø	
M53-8	8	54	23	19	10.5	0.25

56 Acute Angle Elbow (30°-45°)

Type 56 is an ideal fitting to use as an alternative to bending, or when a junction between a sloping tube and an end post is required, i.e. guardrail and staircases. (Refer to page 45 for more information.)

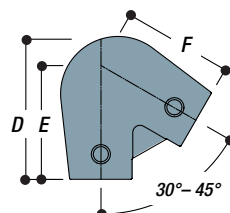
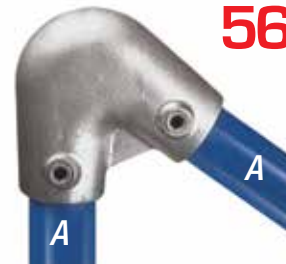

TYPE	Tube ref.	mm			Kg
	A	D	E	F	
56-7	7	105	99	99	0.98
56-8	8	134	112	112	1.29

56A Acute Angle Elbow (11°–30°)

Type 56A is an ideal fitting to use as an alternative to bending, or when a junction between a sloping tube and an end post is required i.e. guardrail on staircases between 11° and 30°

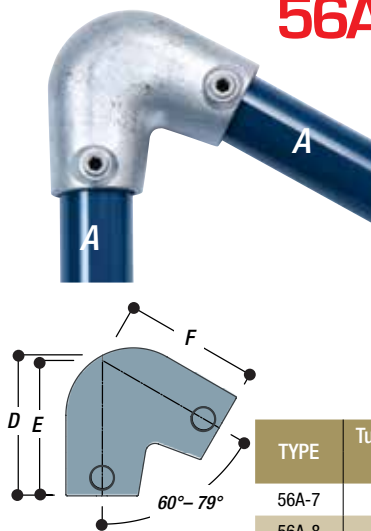

TYPE	Tube ref.	mm			Kg
	A	D	E	F	
56A-7	7	120	108	108	0.94
56A-8	8	125	112	112	1.12

C58 Swivel Flange

A swivel fitting for attachment of angled tubing to a flat surface. For dimensions refer to Type F50 and Type M58.

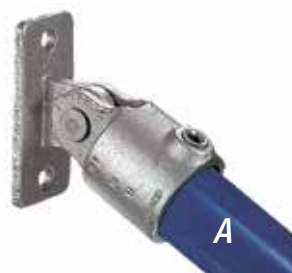

WARNING! C58 is not recommended for use as a base flange to support guardrail, balustrades or other types of structure.

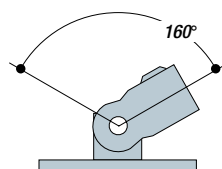

TYPE	Tube ref.	Kg
	A	
C58-5	5	0.70
C58-6	6	0.76
C58-7	7	0.84
C58-8	8	0.94
C58-9	9	0.98

P57 Modified M50-8 with Slot

Designed for the securing of various types of panels and flooring to tube structures (i.e. plywood, plastic sheeting, wood planking, etc.). This fitting has a single offset flange to allow for the attachment of panels to tube. See Type P50.

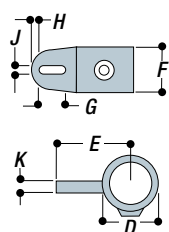

TYPE	Tube ref.	mm						Kg	
	A	D	E	F	G	H	J	K	
P57-8	8	61	77.5	32	22.5	9	10	11	0.30

M58 Swivel Flange Plate

This fitting may be considered for various wall and brace fixings. It is often combined with Type F50 to give an adjustable angle fitting Type C58. The diameter of the attachment bolt hole is 10mm. Ø indicates the diameter of the fixing hole.

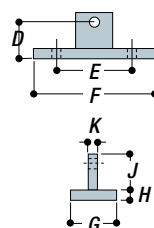

TYPE	mm						Kg		
	D	E	F	G	H	J	K	Ø	
M58	35	84	112	51	6	45	9	11	0.37

P57E Modified P57

This fitting is similar to the P57-8 but has an elongated offset flange with a fixing hole rather than a slot.

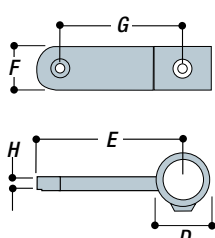
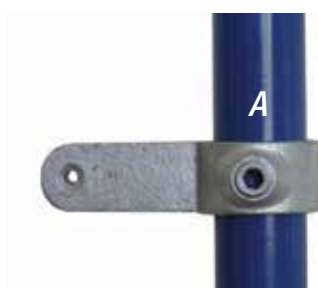

TYPE	Tube ref.	mm					Kg	
	A	D	E	F	G	H	Ø	
P57E-7	7	55	103	32	86	11	6	0.37

P58 Double Central Flange Fitting

This fitting is designed for securing various types of panels and flooring to tubular structures. It has central flanges with fixing holes.

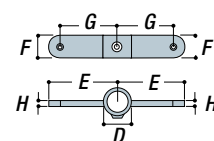
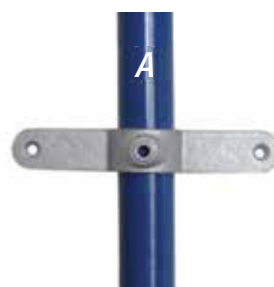

TYPE	Tube ref.	mm					Kg	
	A	D	E	F	G	H	Ø	
P58-7	7	55	103	32	86	11	6	0.56

59 Spigot Flange



A spigot flange which fits inside the tube and is not secured by a socket screw. Type 59 can only be used with a tube wall thickness of 3.2 mm and in light, self supporting structures.

Note: No fixing holes are provided in this fitting.

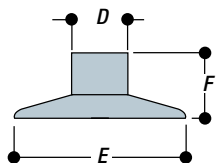

TYPE	Tube ref.		mm				Kg
	A	D	E	F			
59-5	5	18	81	28		0.33	
59-6	6	24	87	32		0.40	
59-7	7	32	98	35		0.60	
59-8	8	38	103	41		0.85	
59-9	9	49	110	48		1.00	

62 Standard Railing Flange

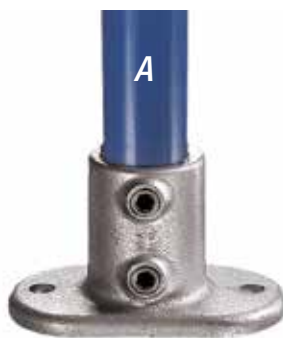

Ideal when a structural fixing is required for guard rail and balustrades. The holes are of sufficient diameter to ensure proper fixing with either a mechanical or chemical anchor. The two set screws in the vertical socket give greater side-load stability to the upright. It is recommended that the fixing holes in the flange should be in line with the applied load (refer to table on page 49). Ø indicates the diameter of the fixing hole.

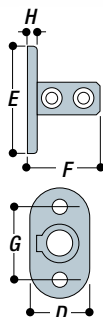

TYPE	Tube ref.		mm					Kg
	A	D	E	F	G	H	Ø	
62-5	5	64	116	76	76	8	11	0.59
62-6	6	76	128	89	89	8	14	0.73
62-7	7	75	140	89	102	10	14	0.97
62-8	8	85	155	89	115	10	14	1.12
62-9	9	102	165	127	127	10	18	1.76

60 Extra Heavy Flange



Heavy duty flange with wide base for spreading loads over a large surface area. Holes provided for countersunk flat head screw fixings only, for use on structures where the fixing required is positional only. Frequently used as a wall fixing bracket (refer to table on page 49).

WARNING! This fitting is not recommended for use as a base flange to support guardrail or balustrades (see Type 62).

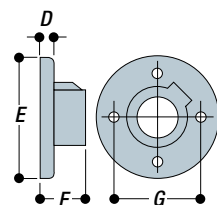

TYPE	Tube ref.		mm					Kg
	A	D	E	F	G	Ø		
60-5	5	14	130	64	79	8	0.89	
60-6	6	14	140	64	86	8	1.15	
60-7	7	14	149	64	95	8	1.30	
60-8	8	14	156	64	102	8	1.48	

262 Round Base Flange



Sleek round base flange. A single fixing hole is hidden to create a more aesthetic look. The two set screws in the vertical socket give greater upright stability. Ø indicates diameter of fixing hole.

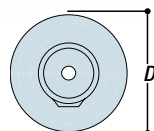

TYPE	Tube ref.		mm				Kg
	A	D	E	F	Ø		
262-8	8	116	89	10	14	0.96	

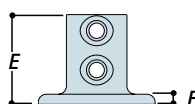

61 Flange

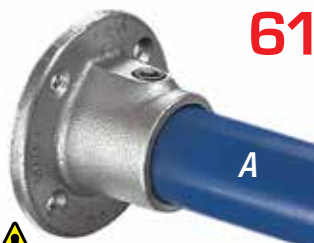

Used on structures where the fixing required is positional only. Frequently used as a wall fixing bracket (refer to table on page 49). Holes provided for countersunk flathead screw fixings only. Ø indicates the diameter of the fixing hole.



WARNING! It is not recommended for use as a base flange to support guardrail or balustrades (see Type 62).

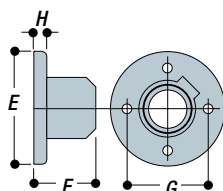

TYPE	Tube ref.		mm					Kg
	A	E	F	G	H	Ø		
61-3	3	70	32	47	6	6.5	0.19	
61-4	4	76	39	54	6	6.5	0.23	
61-5	5	80	40	57	6	6.5	0.33	
61-6	6	90	48	64	6	6.5	0.50	
61-7	7	102	51	76	7	6.5	0.44	
61-8	8	114	59	89	8	6.5	0.67	
61-9	9	127	63	95	10	10	1.08	

63 Angle Base Flange (45°-60°)



Similar to Type 62, but used to set up the upright at an angle between 45° to 60°. This fitting should only be subjected to light loads which cannot be positioned at 90° to the applied load. For greater loads or other tube sizes, a Type 62 flange is used and the upright bent to the required angle (refer to table on page 49). Ø indicates the diameter of the fixing hole.

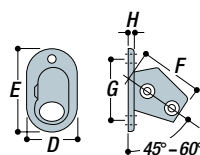

TYPE	Tube ref.		mm					Kg
	A	D	E	F	G	H	Ø	
63-6	6	76	127	92	95	8	14	0.91
63-7	7	76	138	95	106	10	14	1.17
63-8	8	89	155	100	115	10	14	1.53

363 Angle Base Flange (11°–30°)



Similar to a type 63, it is used to set the upright at an angle between 11°–30°. This fitting should only be subjected to light loads which cannot be positioned at 90° to the applied load. For greater loads or other tube sizes a type 62 flange should be used with the upright bent to the required angle (refer to tables on page 49). Ø indicates the diameter of the fixing hole.

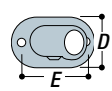
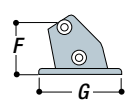

TYPE	Tube ref.	mm					Kg
		A	D	E	F	G	
363-7	7	76	114	85	146	14	0.98
363-8	8	89	124	95	164	14	1.31

265 Offset Rail Wall Flange



Side fixing for guardrail and balustrades to walls, parapets, steps and ramps. Upright cannot drop through the socket. Designed for installations of rail that are offset from which it is being fixed. Ø indicates diameter of fixing hole.

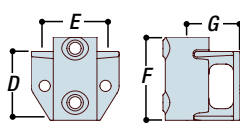

TYPE	Tube ref.	mm					Kg
		A	D	E	F	G	
265-7	7	86	76	104	66	14	1.35
265-8	8	86	94	119	74	14	1.56

64 Standard Vertical Railing Base



Designed for fixing guardrail and balustrades to walls, parapets, steps and ramps. The upright cannot drop through the socket. Access to the top fixing hole is restricted by the position of the flange to the barrel. When selecting a hexagon head bolt or similar bolt fixing, the maximum length of the bolt (including the head) must not exceed 25mm (refer to table on page 49). Ø indicates the diameter of the fixing hole.

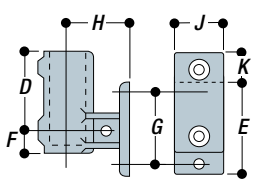

Note: Should an upright be required to pass through the fitting, the base can be bored out to order.

TYPE	Tube ref.	mm								Kg
		A	D	E	F	G	H	J	K	
64-6	6	86	95	22	67	57	45	39	14	0.77
64-7	7	84	108	30	72	64	50	30	14	1.12
64-8	8	89	121	32	89	70	58	28	14	1.54

66 Ground Socket



A ground socket fitting for setting in concrete. The posts may either be permanent or removable as required. It incorporates a socket set screw fixing and can be supplied with a plug to fill the hole when the tube is removed (refer to table on page 49).

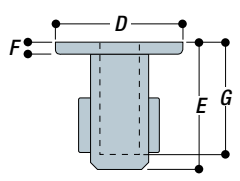

TYPE	Tube ref.	mm				Kg
		A	D	E	F	
66-6	6	127	122	10	115	1.87
66-7	7	140	135	10	127	1.44
66-8	8	140	135	10	127	1.43

65 Standard Horizontal Railing Base



This fitting is designed for palm fixing guardrailing and balustrading to walls, parapets, steps and ramps. The upright cannot drop through the socket (refer to table on page 49). Ø indicates the diameter of the fixing hole.

Note: Should an upright be required to pass through the fitting, the base can be bored out to order.

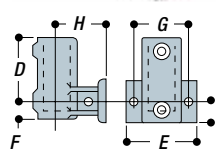

TYPE	Tube ref.	mm							Kg
		A	D	E	F	G	H	J	
65-6	6	83	96	22	67	57	22	14	0.88

67 Angle Flange



Type 67 has been designed to allow the upright to pivot in the barrel, providing an angular displacement from 3° up to a maximum of 11°, measured from the vertical. Ideal to secure balustrade and guardrail systems on access ramps or other types of slopes (refer to table on page 49). Ø indicates the diameter of the fixing hole.

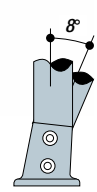

Note: It is generally recommended that, when installing the 67-8, the fixing holes in the base should be in line with the applied load.

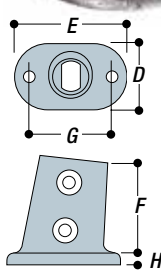

TYPE	Tube ref.	mm					Kg
		A	D	E	F	G	
67-7	7	83	140	79	102	10	1.13
67-8	8	96	155	80	115	10	1.30



68 Wall Flange

Side fixing for guardrailing and balustrading to walls, parapets, steps and ramps. The upright cannot drop through the socket (refer to table on page 49). Ø indicates the diameter of the fixing hole.

Note: If the upright is required to pass through the fitting by machining out the base stop, the bottom fixing hole will be unusable.

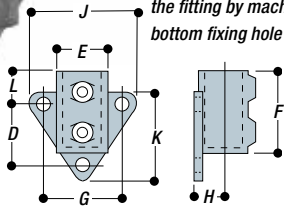

TYPE	Tube ref.	mm									Kg
		A	D	E	F	G	H	J	K	L	
68-6	6	63	45	77	71	24	96	103	25	11	0.62
68-7	7	72	55	83	83	28	108	109	25	11	0.80
68-8	8	78	60	89	86	31	111	116	25	11	0.87

71 Weather Cap

Designed for roof guardrailing to ensure a weathertight seal for base fixing flanges. The weather cap is secured to the upright by means of a combined sealant adhesive.

A separate information sheet detailing fixing instructions is available on request.

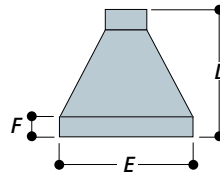

TYPE	Tube ref.	mm			Kg
		A	D	E	
71-6	6	125	143	25	0.24
71-7	7	150	154	25	0.32
71-8	8	155	167	25	0.36



69 Railing Flange with Toeboard Adaptor

Designed for guardrail and balustrade applications with the added benefit of attaching a toeboard to the base. The base plate holes are sufficient diameter to allow for attachment with either a mechanical or chemical anchor. The side plates have slotted holes to allow for a degree of sideways movement for ease of installation. (See page 39 for Toeboard). Ø indicates the diameter of fixing holes.

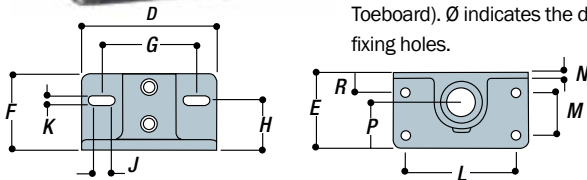

TYPE	Tube ref.	mm											Kg		
		A	D	E	F	G	H	J	K	L	M	N		P	R
69-6	6	130	75	89	95	58	15	10	100	35	7	45	25	11	1.62
69-7	7	145	80	90	97	58	20	10	115	40	7	47	25	11	1.87
69-8	8	160	90	90	112	58	20	10	130	50	7	54	25	11	2.30

72 Stair Tread Support

Suitable for most types of stair tread, including timber, open steel and checker plate. Fixing of the tread is by two bolt holes in each fitting. (Special order only.) Ø indicates the diameter of fixing holes.

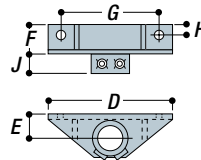

TYPE	Tube ref.	mm								Kg
		A	D	E	F	G	H	J	#	
72-8	8	203	39	51	153	20	33	12	1.25	

WARNING! If Type 72 fittings are to be used for a permanent application or subjected to high loads, the stair tread support tube which is located at its ends should be drilled and pinned to avoid rotational slip.



70 Rail Support

Designed to carry handrails along walls or to fix structures back to walls. The tube passes through the fitting and cannot be joined with the fitting. Type 70 is also used to attach toeboards to the base of guardrail uprights. Holes provided for countersunk flat head screw fixings only.

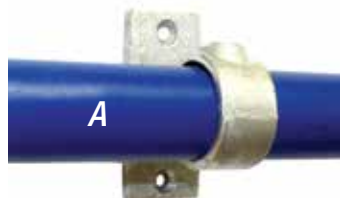

WARNING! Type 70 fittings are not designed to be used as base flanges for full height guardrails or handrails.

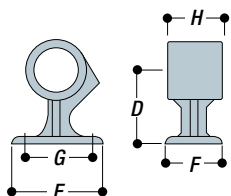

TYPE	Tube ref.	mm						Kg
		A	D	E	F	G	H	
70-5	5	54	76	46	57	30	8	0.36
70-6	6	57	82	44	63	30	8	0.46
70-7	7	63	102	44	76	34	8	0.57
70-8	8	67	108	48	85	34	8	0.62

75 Collar

Commonly used to support another fitting if the latter is required to be left untightened, such as gate hinges. Type 75 is also useful when the loading on a structure exceeds the maximum permitted slip load for a socket set screw, as it provides additional support.

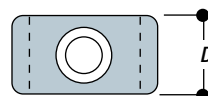

TYPE	Tube ref.	mm	Kg
		D	
75-4	4	22	0.05
75-5	5	25	0.09
75-6	6	26	0.13
75-7	7	25	0.15
75-8	8	25	0.19

76 Hook

A fitting normally used for attachment of chains.

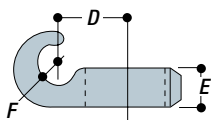

TYPE	Tube ref.	mm			Kg
	A	D	E	F	
76-5	5	28	25	28	0.17
76-6	6	35	25	13	0.21
76-7	7	40	25	40	0.23
76-8	8	41	25	13	0.24

77 Plastic Plug

A grey plastic plug to fit open ended tubes. See also Type 84. Suitable for medium and heavy tubing only.



TYPE	Tube ref.	Kg
	A	
77-4	4	0.001
77-5	5	0.008
77-6	6	0.010
77-7	7	0.010
77-8	8	0.016
77-9	9	0.024

78 Eye Fitting

Used in conjunction with Type 83 fitting for gate hinges. \emptyset indicates diameter of pivot hole.

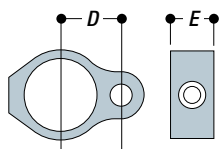

TYPE	Tube ref.	mm			Kg
	A	D	E	\emptyset	
78-5	5	30	25	14	0.21
78-6	6	33	26	14	0.25
78-7	7	38	26	14	0.26
78-8	8	41	26	14	0.28

79 Sheeting Clip

This fitting is used to attach profiled sheeting material to tube. The fitting is supplied with the following hardware: one M6 x 50mm roofing bolt, on M6 square nut, and one M6 lock washer. BZP finish. \emptyset indicates diameter of bolt hole.

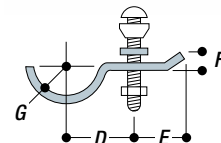

TYPE	Tube ref.	mm					Kg
	A	D	E	F	G	\emptyset	
79-7	7	46	34	8	21	8	0.08

81 Single Sided Clip

For attaching wire mesh infill. For economy, it is possible to use Type 81 clips without the safety attachment to secure various types of infill panels (plyboard, perspex, etc.) up to a thickness of 10mm. All clips are supplied with hexagonal head fixing bolts, M6 x 35mm long and nut. The primary clip has a slot measuring 8 x 15mm. \emptyset indicates diameter of the safety attachment bolt hole.

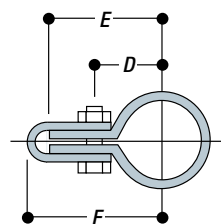
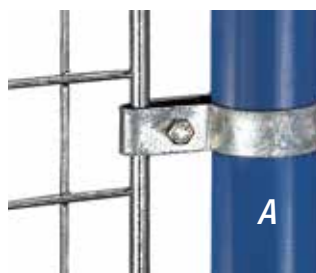

Note: For D and E dimensions the figures are given for the respective minimum and maximum dimensions allowed by the slotted hole.

TYPE	Tube ref.	mm				Kg
	A	D	E	F	\emptyset	
81-5	5	24	39	56	7.5	0.07
81-6	6	27	42	59	7.5	0.08
81-7	7	32	47	64	7.5	0.08
81-8	8	34	49	66	7.5	0.09
81-9	9	40	55	72	7.5	0.10

82 Double Sided Clip

For attaching wire mesh infill. For economy it is possible to use Type 82 clips without the safety attachment, to secure various types of infill panels (plyboard, perspex, etc.) up to a thickness of 10mm. All clips are supplied with hexagonal head fixing bolts, M6 x 35mm long, and nut. The primary clip has a slot measuring 8mm x 15mm. \emptyset indicates diameter of the safety attachment bolt hole.

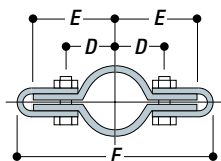
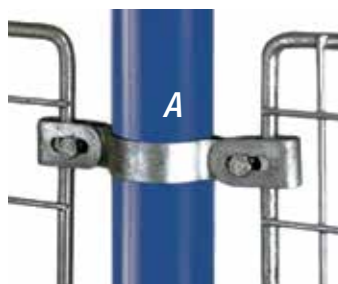

Note: For D and E dimensions the figures are given for the respective minimum and maximum dimensions allowed by the slotted hole.

TYPE	Tube ref.	mm				Kg
	A	D	E	F	\emptyset	
82-5	5	24	39	112	7	0.11
82-6	6	27	42	118	7	0.12
82-7	7	32	47	128	7	0.13
82-8	8	34	49	132	7	0.14
82-9	9	40	55	144	7	0.14

83 Pin Fitting

This fitting is used in conjunction with Type 78 for gate hinges.

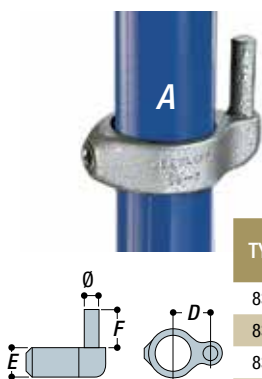

TYPE	Tube ref.	mm				Kg
	A	D	E	F	Ø	
83-5	5	30	26	38	13	0.20
83-6	6	33	25	38	13	0.25
83-7	7	38	25	38	13	0.29
83-8	8	41	26	38	13	0.30

87 Angle Elbow (0°–11°)

Used to join the top rail to an end upright on a guardrail on a slope from 0° to 11°. Tube cannot be joined within this fitting.

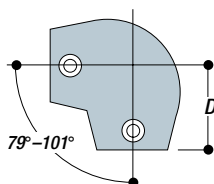
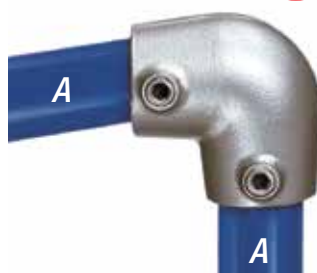

TYPE	Tube ref.	mm		Kg
	A	D		
87-7	7	60		0.70
87-8	8	68		0.90

84 Malleable Plug

A metal drive-in plug which is difficult to remove when installed. For an alternative in plastic, see Type 77.

Note: This fitting can only be used with EN 10255 (ISO 65) medium weight tubing.

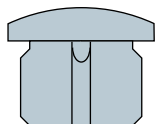

TYPE	Tube ref.	Kg
	A	
84-5	5	0.05
84-6	6	0.10
84-7	7	0.12
84-8	8	0.17
84-9	9	0.29

88 Three Socket Angle Tee (0°–11°)

Used to join the top rail to an intermediate upright on a guardrail on a slope from 0° to 11°. As there are two socket set screws in the sleeve, this fitting can be used to join two ends of rail.

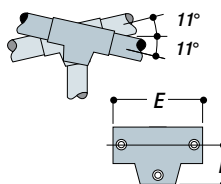
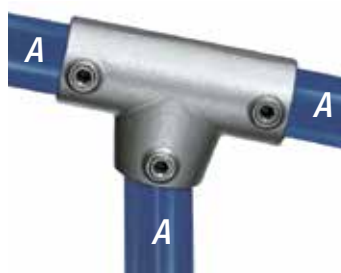

TYPE	Tube ref.	mm		Kg
	A	D	E	
88-7	7	60	144	1.02
88-8	8	68	158	1.24

The Slope Range (86–89)

The slope range of fittings consists of fitting Types 86, 87, 88, 89. These fittings are designed to facilitate in-line railings with vertical posts on slopes with angles between 0° and 11°. They can be used to construct railings on access ramps for people with disabilities when used in conjunction with the **KEE LITE** Type L160 fitting.

86 Angle Tee (0°–11°)

Used to join the middle rail to an upright on a guardrail on a slope from 0° to 11°. Tube cannot be joined within this fitting.

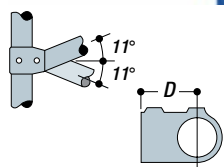
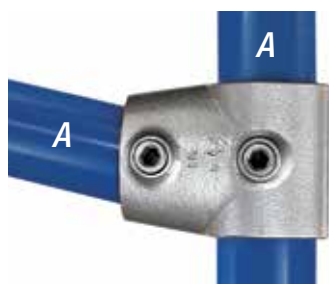

TYPE	Tube ref.	mm	Kg
	A	D	
86-7	7	60	0.55
86-8	8	68	0.63

89 Two Socket Angle Cross (0°–11°)

Used to join the middle rail to an intermediate upright on a guardrail on a slope from 0° to 11°. The upright passes through the fitting.

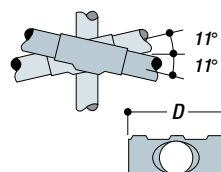

TYPE	Tube ref.		mm	Kg
	A	B	D	
89-7	7	7	144	0.70
89-8	8	8	158	0.85
89-87	8	7	155	0.76

The PGR Range (90–95)

These are known as Pedestrian Guardrail (PGR) fittings and are used as an alternative to Types 10, 15, 25 and 26 when the site is not straight and level. There is sufficient play within the fitting to negotiate a slope up to 7 degrees or a radius greater than 6 metres, when the uprights are 2 metre centres, using straight tube. They also allow damaged rails to be removed without dismantling the adjacent structure. The 90 to 95 range of fittings is available in size 8.



90 PGR Three Socket Tee

Type 90 is used to join the top rail to an intermediate upright.

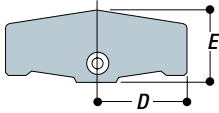

TYPE	Tube ref.	mm		Kg
	A	D	E	
90-8	8	99	88	1.56

91 PGR Two Socket Cross

Type 91 is used to join the mid-rail to an intermediate upright.

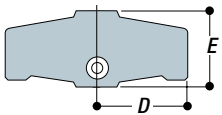

TYPE	Tube ref.	mm		Kg
	A	D	E	
91-8	8	99	89	1.48

92 PGR Elbow

Type 92 is used to join the top rail to an end post.

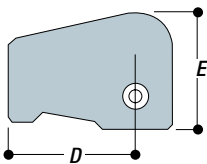
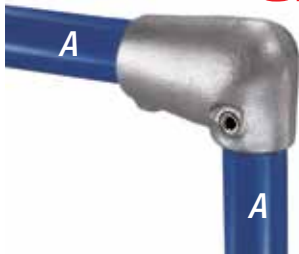

TYPE	Tube ref.	mm		Kg
	A	D	E	
92-8	8	99	89	1.29

93 PGR Tee

Type 93 is used to join the mid-rail to an end post.

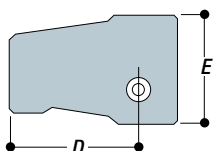
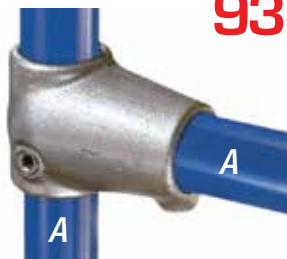

TYPE	Tube ref.	mm		Kg
	A	D	E	
93-8	8	99	89	1.20

95 PGR Internal Spigot

Internal spigot designed to prevent sagging of bends when using the 90 to 95 range of fittings.

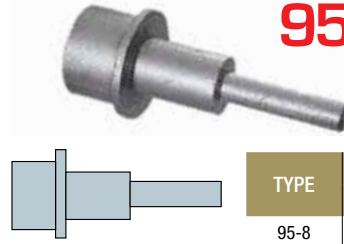

TYPE	Tube ref.	Kg
95-8	8	0.46

97 Set Screws

Socket set screws are supplied and inserted in all **Kee Safety** fittings as standard, the case hardened set screws that are fitted to **KEE KLAMP** and **KEE ACCESS** components are coated with **KEE KOAT**. This unique **Kee Safety** product ensures at least four times the corrosion resistance of bright zinc plated alternatives. **KEE LITE** components are all supplied and fitted with grade 1.4301 Stainless Steel set screws.



TYPE	To suit tube sizes	Size	Finish
97-3	3	5/16" BSF	BZP
97-4	4	3/8" BSF	BZP
97-56	5 6	ISO 228 1/4"	KEE KOAT
97-789	7 8 9	ISO 228 3/8"	KEE KOAT
97-56050	5 6	ISO 228 1/4"	Grade 1.4301 Stainless Steel
97-78950	7 8 9	ISO 228 3/8"	Grade 1.4301 Stainless Steel

99 Hex Key

Simple hex key. A/F refers to the dimension across the flats.

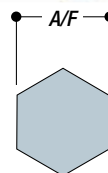

TYPE	To suit tube sizes	A/F
99-3	3	5/32"
99-4	4	3/16"
99-56	5 6	1/4"
99-789	7 8 9	5/16"

100 Plastic Set Screw Cap

Grey plastic set screw caps provide the perfect finishing touch to galvanised **KEE KLAMP** fittings. Secure push-in-fit application.



TYPE	To suit tube sizes	mm		
		D	E	
100-56	5 6	6	16	To fit 97-5 and 97-6 set screws
100-789	7 8 9	6	16	To fit 97-7, 97-8 and 97-9 set screws

105 Sheetling Clip without Hardware

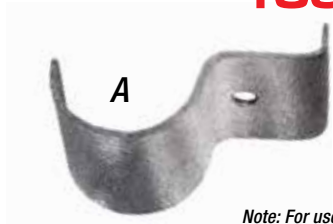

This clip is used to attach profiled or flat sheeting. It is supplied with fixings. \emptyset indicates diameter of bolt hole.

Note: For use where fixing required is positional only. Clip is not intended to bear substantial load.

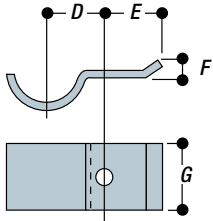

TYPE	Tube ref.	mm					Kg
		A	D	E	F	G	
105-6	6	32	38	13	50	9	0.14
105-7	7	38	40	13	50	9	0.16
105-8	8	40	40	13	50	9	0.18
105-9	9	48	40	13	50	9	0.23

S115 Packer Plate for Type 115



Type S115 allows the Type 115 fitting to be positioned in channels, slots and other offset areas. \emptyset indicates diameter of fixing holes.

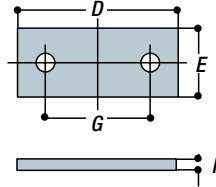

TYPE	mm					Kg
	D	E	F	G	\emptyset	
S115	150	65	12	100	14	0.87

114 Swivel Tee

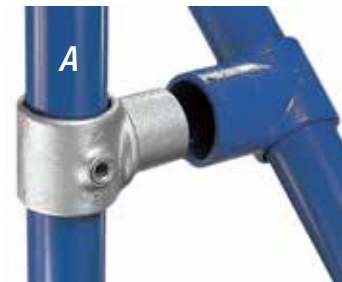

An internal swivel fitting, designed to accommodate varying angles on handrailing to staircases, ramps or bracing. Used in conjunction with Types 10, 15, 25 or 45.

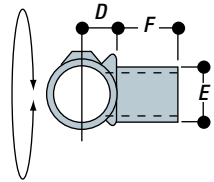

TYPE	Tube ref.	mm			Kg
		A	D	E	
114-6	6	23	33	29	0.36
114-7	7	27	42	36	0.47
114-8	8	30	49	41	0.58

118 Cover Flange



This fitting slips over uprights to finish below ground post installations. The fitting is secured to the upright tube with a single recessed set screw.

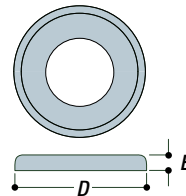

TYPE	Tube ref.	mm		Kg
		D	E	
118-8	8	100	15	0.40

115 Horizontal Railing Base



Type 115 is designed for palm fixing of guardrail and balustrades to walls, parapets, steps and ramps. The upright cannot drop through the socket. Packer plates, Type S115, are available to allow the fitting to be positioned in channels, slots and other offset areas. \emptyset indicates diameter of fixing hole.

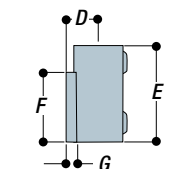
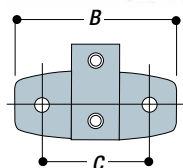

TYPE	Tube ref.	mm							Kg
		A	B	C	D	E	F	G	
115-6	6	150	100	30	90	65	10	14	1.08
115-7	7	150	100	35	90	65	10	14	1.23
115-8	8	150	100	41	90	65	13	14	1.42

121 Corner Crossover

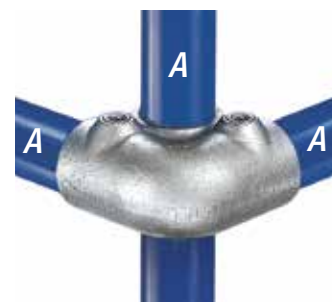

This fitting is designed to provide a 90° offset corner joint. When calculating the cutting lengths for tubing, dimension 'G' should be subtracted to give the tube length for the rails and dimension 'H' should be added to give the tube length for the upright.

Note: To obtain the true height of the upright the allowance for the base fittings must be included.

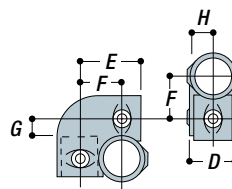

TYPE	Tube ref.	mm					Kg
		A	D	E	F	G	
121-7	7	55	72	49	22	28	0.92

145 Crossover Coupling

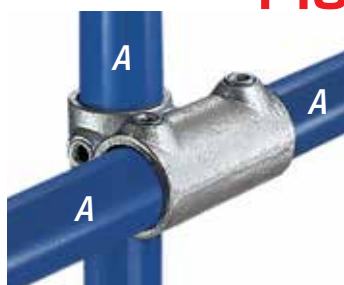

Designed to give a 90° offset crossover. As there are two socket set screws in the sleeve, this **KEE KLAMP** fitting can be used where a join is required in the horizontal tube. For economy, it is possible to use a Type 45 in place of the 145, using the 145 only where a join in the tube occurs. When calculating the cutting lengths for tube, dimension 'G' should be added to give the tube length for the upright.

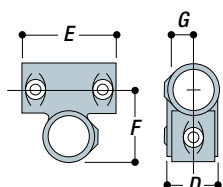

Note: To obtain the true height of the upright the allowance for the base fittings must be included.

TYPE	Tube ref.		mm					Kg
	A	D	E	F	G	H		
145-7	7	55	72	49	22	28	0.92	

The Slope Range (320-427)

This slope range of fittings is designed specifically for use on steeper gradients and consists of fitting Types 320, 321, 325, 326, 427. These fittings are designed to facilitate in-line railings with vertical posts where the slope is greater than 30°.

316 Parapet Flange

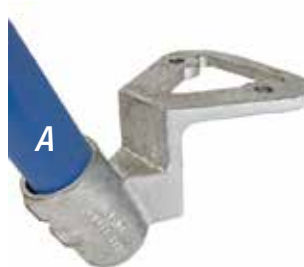

A component designed to retrofit onto roof parapets that are at an unsafe height. Upright tube is angled 25 degrees from the vertical so that the building's visage is unaffected by the installed Guardrailing. Two holes are located in the top mounting bracket for fixing directly into the parapet. The two set screws in the vertical socket give greater side-load stability to the angled upright. Engineered weep hole allows water to drain. Ø indicates diameter of fixing hole.

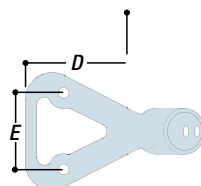

TYPE	Tube ref.		mm			Kg
	A	D	E	Ø		
316-7	7	170	100	14	1.88	
316-8	8	170	100	14	2.05	

199 Single Sided Fixing Bracket



The Type 199 is used as an attachment point for flat sheets or boards and comes supplied with a drilled hole.

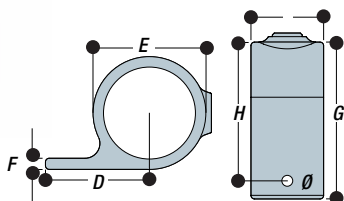

TYPE	Tube ref.		mm						Kg
	A	D	E	F	G	H	Ø		
199-6	6	45	73	5	60.5	25	8.5	0.27	
199-7	7	53	80.5	6	53	40	6	0.36	
199-8	8	56	86.5	6	56	40	6	0.36	

200 Double Sided Fixing Bracket

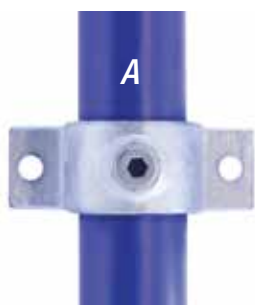

The Type 200 is used as an attachment point for flat sheets or boards and comes supplied with a drilled hole.

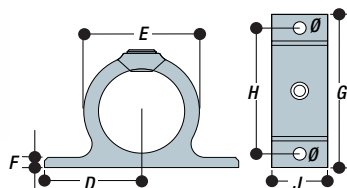

TYPE	Tube ref.		mm							Kg
	A	D	E	F	G	H	J	Ø		
200-6	6	45	45	5	90	70	25	6.5	0.18	
200-7	7	53	55	6	106	86	40	11.5	0.38	
200-8	8	56	66.7	6	112	92	40	11.5	0.59	

320LH Left hand level to Sloping Down Side Outlet Elbow (30° -45°)

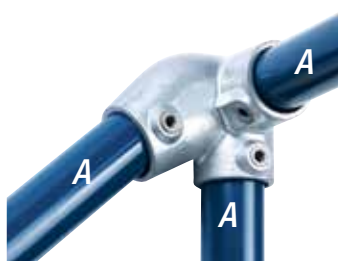

Left Hand Side Outlet Elbow fitting designed for the top rail on guardrail on slopes and staircases between 30° and 45° at the junction where the handrail changes from level to sloping down the stairs

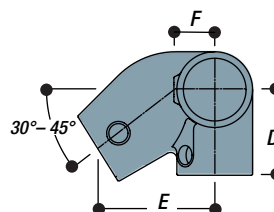

TYPE	Tube ref.		mm			Kg
	A	D	E	F		
320LH-7	7	60	86	29	1.08	
320LH-8	8	68	93	32	1.28	

320RH Right hand level to Sloping Down Side Outlet Elbow (30° –45°)

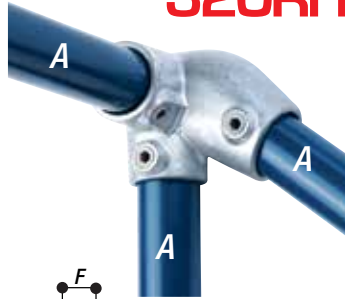

Right Hand Side Outlet Elbow fitting designed for the top rail on guardrail on slopes and staircases between 30° and 45° at the junction where the handrail changes from level to sloping down the stairs

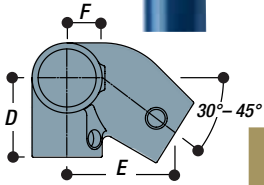

TYPE	Tube ref.	mm			Kg
	A	D	E	F	
320RH-7	7	60	86	29	1.08
320RH-8	8	68	93	32	1.28

325 Level to Sloping Down Tee (30° –45°)

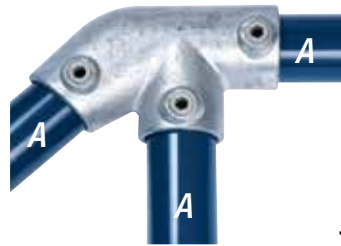

Tee fitting designed for the top rail on guardrail on slopes and staircases between 30° and 45° at the junction where the handrail changes from level to sloping down the stairs

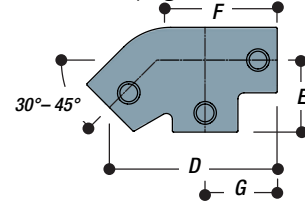

TYPE	Tube ref.	mm				Kg
	A	D	E	F	G	
325-7	7	142	60	89	60	1.02
325-8	8	154	68	100	68	1.12

321LH Left hand level to Sloping Down Side Outlet Tee (30° –45°)

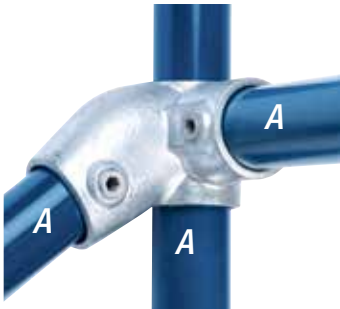

Left Hand Side Outlet Tee fitting designed for the mid rail on guardrail on slopes and staircases between 30° and 45° at the junction where the handrail changes from level to sloping down the stairs

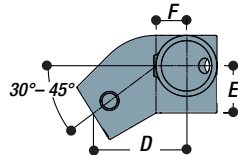

TYPE	Tube ref.	mm			Kg
	A	D	E	F	
321LH-7	7	86	27	29	0.96
321LH-8	8	92	30	32	1.12

325A Level to Sloping Up Tee (30° –45°)

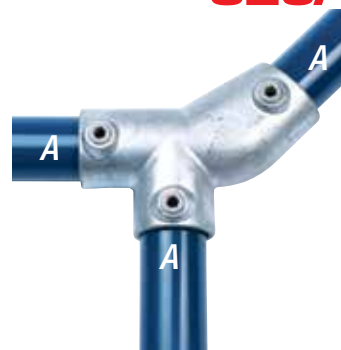

Tee fitting designed for the top rail on guardrail on slopes and staircases between 30° and 45° at the junction where the handrail changes from level to sloping up the stairs

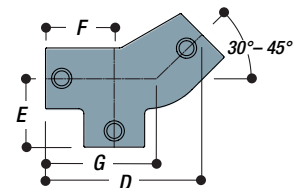

TYPE	Tube ref.	mm				Kg
	A	D	E	F	G	
325A-7	7	142	60	60	89	1.02
325A-8	8	155	68	68	100	1.12

321RH Right hand level to Sloping Down Side Outlet Tee (30° –45°)

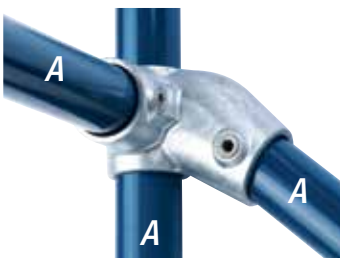

Right Hand Side Outlet Tee fitting designed for the mid rail on guardrail on slopes and stair-cases between 30° and 45° at the junction where the handrail changes from level to sloping down the stairs

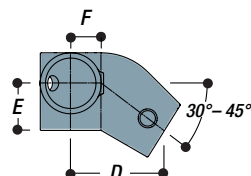

TYPE	Tube ref.	mm			Kg
	A	D	E	F	
321RH-7	7	86	27	29	0.96
321RH-8	8	92	30	32	1.12

326 Level to Sloping Down or Up Cross (30° –45°)

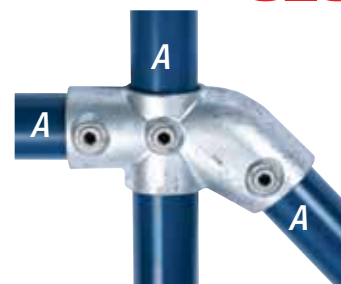

Cross fitting designed for the mid rail on guardrail on slopes and staircases between 30° and 45° at the junction where the handrail changes from either level to sloping down or level to sloping up the stairs

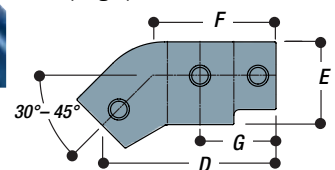

TYPE	Tube ref.	mm				Kg
	A	D	E	F	G	
326-7	7	142	68	89	60	0.82
326-8	8	154	74	100	68	0.95

350 Eaves Fitting

The Type 350 fitting has been designed for small structural building applications and provides for significant load rating. When used with the Type 351 ridge fitting a truss arrangement for additional support can be achieved. Double set screws are provided on the truss outlet to provide additional pull out resistance to hold structures firmly together.

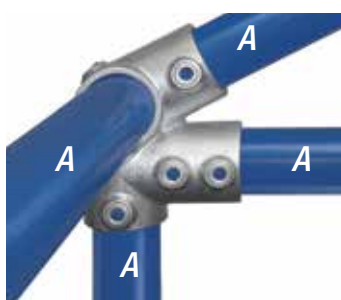

351 Ridge Fitting

Designed for small structural building applications and provides for significant load rating. When used with the Type 350 eaves fitting a truss arrangement for additional support can be achieved. Double set screws are provided on the downward truss outlet to provide additional pull out resistance and extra strength to the structure.

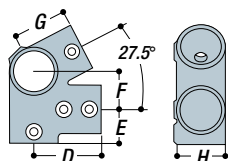
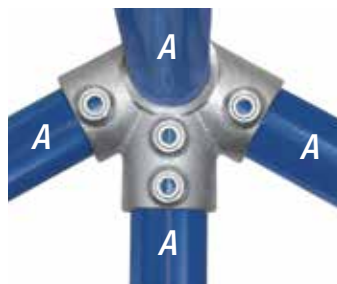

TYPE	Tube ref.	mm					Kg
350-8	A	D	E	F	G	H	1.24

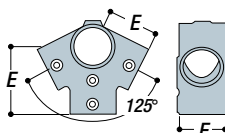

TYPE	Tube ref.	mm			Kg
351-8	A	D	E	F	0.92





Aluminium Safety Components

KEE LITE components are made from a high grade Aluminium Silicon Magnesium Alloy. The components are strong yet light, and extremely durable – even in harsh environments. They are only one-third the weight of iron fittings, with about 75% of comparable tensile strength. **KEE LITE** fittings are designed to suit BS EN755 tube.

KEE LITE components offer flexibility and can be used in a variety of applications, from contemporary to industrial: your imagination is the only limitation.

Because **KEE LITE** can be easily installed with a hex tool and tube cutters, there is no need for welding or specialist installation skills, saving you both time and money. **KEE LITE** is securely locked into place using recessed set screws that provide a sleek and smooth look to your railing system.

KEE LITE components are available for tube sizes 25, 32, 40 and 50 N.B.

Fittings by Function

Couplings

L14Straight

Crosses

L26Two Socket
L3030° – 45° Adjustable
L35Three Socket

Crossovers

L45Crossover
L46Combination Socket Tee

Elbows

L1590°
L20Side Outlet
LB54Adjustable

Flanges

LC58Swivel
LM58Male Wall Plate
L61Round
L62Standard Railing
L68Wall
L69Railing Flange with
Toeboard Adaptor
L148Heavy Duty Rectangular
L150Heavy Duty Four Hole
Square
L152Four Hole Square
L164Offset Wall

Brackets

L70Rail Support
L160Smooth Handrail Fitting
475Aluminium Wall Bracket

Plugs

77Plastic
L84Aluminium

Combination Swivels

LC50Single Combination
LF50Female Single
LM50Male Single
LC51Double Combination
LM51Male Double
LC52Corner Combination
LM52Male Corner

Tees

L10Single Socket
L19Adjustable Side Outlet
L2190° Side Outlet
L25Three Socket
L2930° – 60° Single Socket
L46Combination Socket Tee
and Crossover
L114Swivel

Toeboard Kits

TBIToeboard

Miscellaneous

L69Railing Flange with
Toeboard Adaptor
Gaskets...Neoprene Flange Gaskets



L10 Single Socket Tee

Designed to give a 90° butt joint between two tubes. Frequently used for the joint between end uprights and the middle rail where the railing site is straight and level. Also used for base ties on racking. This fitting cannot be used where the tube passing through the sleeve is required to be joined within the fitting.

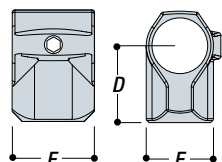
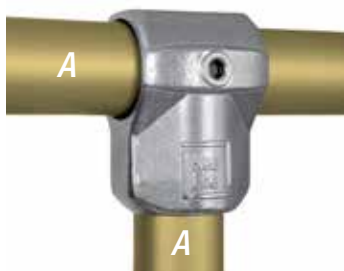

TYPE	Tube ref.	mm			Kg
	A	D	E	F	
L10-6	6	52	42	56	0.13
L10-7	7	65	53	64	0.20
L10-8	8	74	60	70	0.30
L10-9	9	90	74	82	0.48

L19 Adjustable Side Outlet Tee (60° -200°)

Used to form variable angle joints between 60° and 200°. Not designed to absorb bending loads at barrier intersection.

Note: Type L19 fittings are bagged in pairs and are weighed, priced, and sold as such. Weight below refers to pairs.

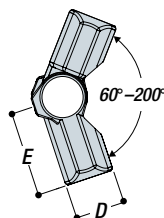
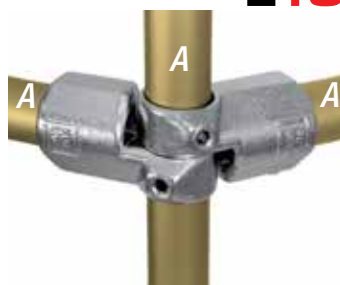

TYPE	Tube ref.	mm		Kg
	A	D	E	
L19-6	6	42	75	0.36
L19-7	7	53	90	0.58
L19-8	8	60	90	0.66

L14 Straight Coupling

Designed to give an in-line joint between tubes of the same size. Frequently used to enable full tube lengths to be used in railing applications.

Note: It is not advisable to join the upper and lower rails of a railing within the same bay.

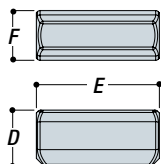

TYPE	Tube ref.	mm			Kg
	A	D	E	F	
L14-6	6	50	100	42	0.18
L14-7	7	59	130	53	0.24
L14-8	8	65	148	60	0.36

L20 Side Outlet Elbow (90°)

A 90° corner joint most frequently used for the top rail of safety railing. It can also be used for the corner joint of benches, work tables and other rectangular structures.

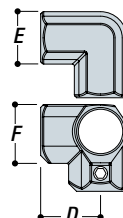
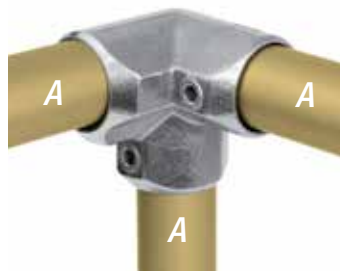

TYPE	Tube ref.	mm			Kg
	A	D	E	F	
L20-6	6	52	42	50	0.19
L20-7	7	65	53	59	0.35
L20-8	8	74	60	65	0.50

L15 Elbow (90°)

A 90° elbow joint, most frequently used as an end joint for the top rail of safety railing on a level site.

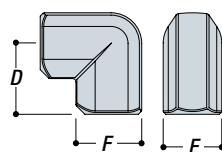
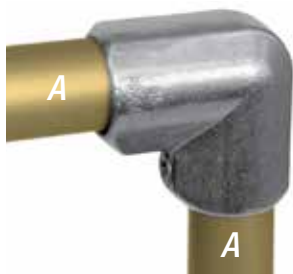

TYPE	Tube ref.	mm			Kg
	A	D	E	F	
L15-6	6	52	42	56	0.14
L15-7	7	65	53	59	0.28
L15-8	8	74	60	65	0.40
L15-9	9	90	74	78	0.66

L21 Side Outlet Tee (90°)

Most frequently paired with type L20 to give a 90° corner joint for the middle rail of safety railing and other rectangular structures. The upright passes through the fitting.

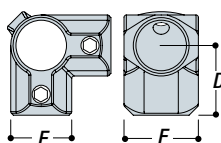
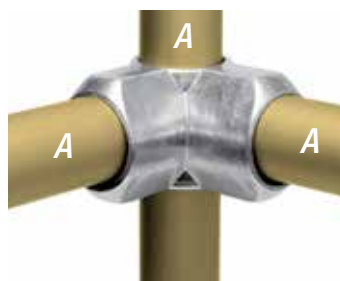

TYPE	Tube ref.	mm			Kg
	A	D	E	F	
L21-6	6	52	42	56	0.16
L21-7	7	65	53	64	0.30
L21-8	8	74	60	70	0.43

L25 Three Socket Tee

Commonly used as the 90° joint between the top rail and an intermediate upright on safety railing. As there are two socket set screws in the sleeve, this fitting can be used where a join is required in the horizontal tube. The Type L10 fitting can be used as an alternative when a join in the tube is not required.

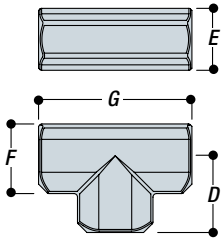
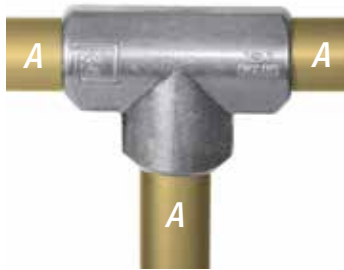

TYPE	Tube ref.	mm				Kg
		A	D	E	F	
L25-6	6	52	42	50	104	0.21
L25-7	7	65	53	59	130	0.35
L25-8	8	74	60	65	148	0.51
L25-9	9	90	74	78	180	0.93

L30 Adjustable Cross (30°–45°)

This adjustable fitting can be used for railing on staircases between the mid-rail and intermediate upright which is required to remain vertical. It can be used at any selected angle between 30° and 45°.

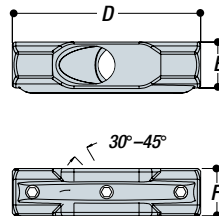
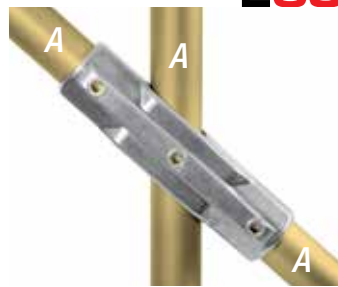

TYPE	Tube ref.	mm			Kg
		A	D	F	
L30-7	7	215	53	54	0.52
L30-8	8	245	59	60	0.83

L26 Two Socket Cross

Usually paired with Type L25 to give a 90° joint between the middle rail and an intermediate upright on safety railing. The upright passes through the fitting.

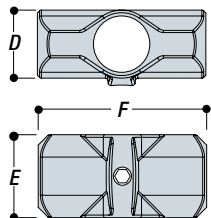
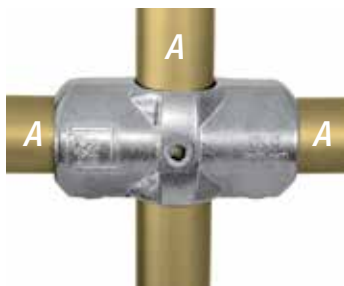

TYPE	Tube ref.	mm			Kg
		A	D	F	
L26-6	6	42	56	104	0.17
L26-7	7	53	64	130	0.28
L26-8	8	60	70	148	0.45
L26-9	9	74	82	180	0.66

L35 Three Socket Cross

Most frequently used to tie uprights with horizontal tube in three directions, all 90° to the upright. The upright passes through the fitting.

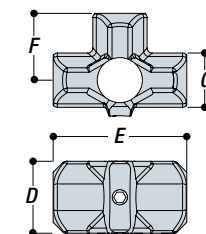
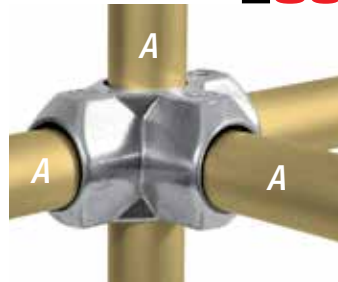

TYPE	Tube ref.	mm				Kg
		A	D	F	G	
L35-6	6	43	56	104	52	0.31

L29 Single Socket Tee (30°–60°)

This adjustable fitting is most frequently used for struts and braces. It can be used at any selected angle between 30° and 60°. Suitable for connecting an angled staircase rail to a vertical upright.

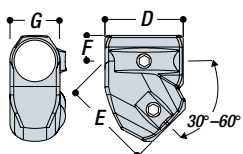
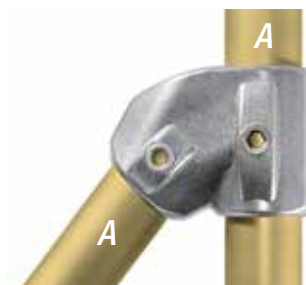

TYPE	Tube ref.	mm				Kg
		A	D	F	G	
L29-7	7	82	95	27	53	0.32
L29-8	8	93	108	30	59	0.41

L45 Crossover

Designed to give a 90° offset crossover joint. Frequently used on safety railing utilising a continuous horizontal rail, minimising tube cuts to reduce costs. Type L45 may also be used to allow intermediate levels on racks.

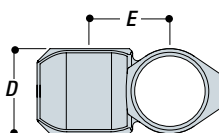
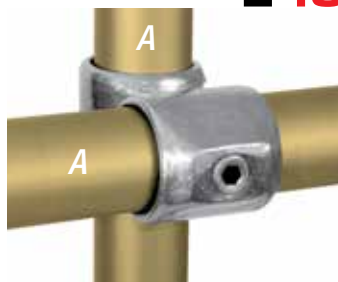

TYPE	Tube ref.	mm		Kg
		A	E	
L45-6	6	44	40	0.12
L45-7	7	54	50	0.21
L45-8	8	61	56	0.35

Note: Tube cannot be joined with this fitting.

L46 Combination Socket Tee and Crossover

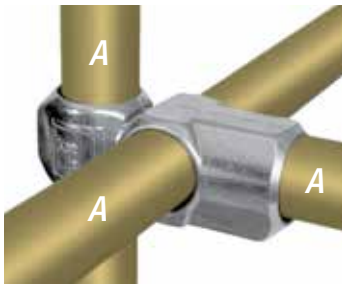

Used on racking to join horizontal carrying rails to the upright, leaving the socket to take a horizontal tube outside the upright. On pallet racking, it is preferable to have the carrying rails inside the upright.

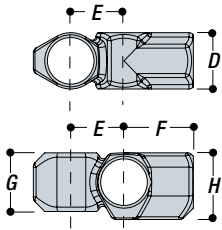

TYPE	Tube ref.		mm					Kg
	A	D	E	F	G	H		
L46-6	6	42	40	52	44	50	0.19	

LM50 Male Single Swivel Socket Member



The male portion of a swivel component combination. The fitting can also be used to attach flat panels to tubular structures.

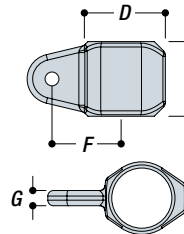

TYPE	Tube ref.		mm					Kg
	A	D	E	F	G	Ø		
LM50-6	6	50	44	47	11	10	0.12	
LM50-7	7	59	51	50	11	10	0.15	
LM50-8	8	65	60	55	11	10	0.20	

LC50 Single Swivel Socket

A complete combination swivel fitting, variable through 170°.

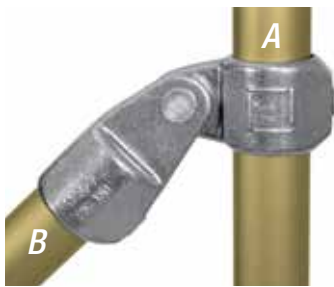

Note: Swivel fittings are not designed to resist bending loads. A structure should not be designed entirely of swivel fittings as they will not provide sufficient stability for the structure.

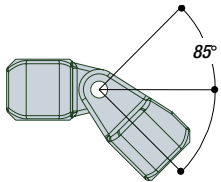

TYPE	Tube ref.		Kg
	A	B	
LC50-66	6	6	0.21
LC50-77	7	7	0.44
LC50-88	8	8	0.53

LC51 Double Swivel Socket

Complete combination fitting. Reducing combinations of Type LC51 are available in sizes 6, 7 and 8.

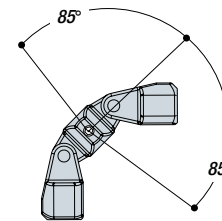
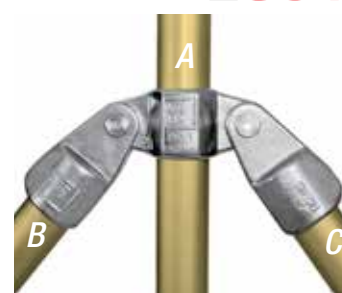

TYPE	Tube ref.			Kg
	A	B	C	
LC51-666	6	6	6	0.48
LC51-777	7	7	7	0.69
LC51-888	8	8	8	0.77

LF50 Female Single Swivel Socket Member

The female part of a swivel component combination.

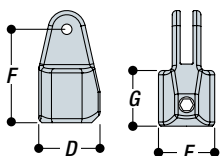

TYPE	Tube ref.		mm				Kg
	A	D	E	F	G		
LF50-6	6	50	42	75	53	0.17	
LF50-7	7	59	53	90	59	0.25	
LF50-8	8	65	60	90	67	0.29	

LM51 Male Double Swivel Socket Member

One half of a combination component. This component can also be used for attaching flat panels to tubular structures.

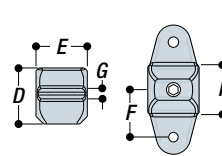

TYPE	Tube ref.		mm					Kg
	A	D	E	F	G	H	Ø	
LM51-6	6	50	44	47	11	42	10	0.16
LM51-7	7	59	51	50	11	53	10	0.20
LM51-8	8	65	60	55	11	60	10	0.27

LC52 Corner Swivel Socket

Complete combination component. Reducing combinations of Type LC52 are available in sizes 6, 7 and 8. See Type LM52 and Type LF50 for measurements.

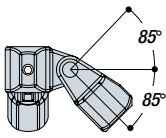
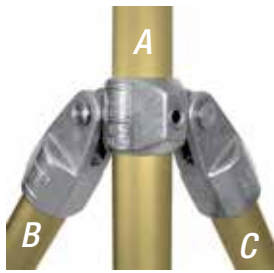

TYPE	Tube ref.			Kg
	A	B	C	
LC52-666	6	6	6	0.59
LC52-777	7	7	7	0.67
LC52-888	8	8	8	0.85

LC58 Swivel Flange

A swivel fitting for attachment of angled tube to a flat surface. See Type LM58 and Type LF50 for measurements. Ø indicates diameter of fixing holes.



Note: This fitting is not recommended for use as a base flange to support guardrail or balustrades.

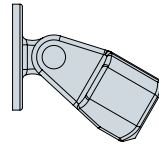

TYPE	Tube ref.	mm		Kg
		A	Ø	
LC58-6	6	11	0.34	
LC58-7	7	11	0.40	
LC58-8	8	11	0.47	

LM52 Male Corner Swivel Socket Member

One half of a combination component. This component can also be used for attaching flat panels to tubular structures. Ø indicates diameter of rivet holes.

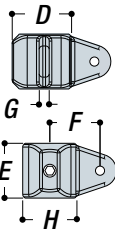
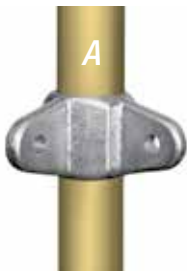

TYPE	Tube ref.	mm						Kg
		A	D	E	F	G	H	
LM52-6	6	50	44	47	11	42	10	0.16
LM52-7	7	59	51	50	11	53	10	0.23
LM52-8	8	65	60	55	11	60	10	0.27

LM58 Swivel Flange Plate

This may be considered for various wall and brace fixings, usually combined with Type LF50 to give an adjustable angle fitting Type LC58. Ø indicates diameter of holes.

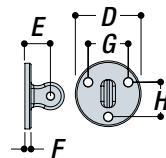

TYPE	mm					Rivet hole dia. (mm)	Fixing hole dia. (mm)	Kg
	D	E	F	G	H			
LM58	86	34	8	53	45	10	11	0.17

LB54 Adjustable Elbow (45°–200°)

A swivel fitting designed as an in-line variable angle connection, adjustable from 45° to 200°. Nut and bolt included.

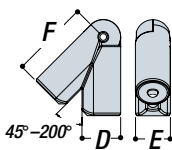
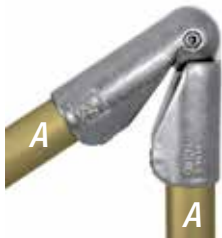

TYPE	Tube ref.	mm			Kg
		A	D	E	
LB54-66	6	50	42	100	0.35
LB54-77	7	58	55	119	0.65
LB54-88	8	65	60	131	0.73

L61 Flange

This flange, with holes provided for countersunk head fixing screws only, is used in structures where the fixing required is positional only. Frequently used as a wall fixing bracket. Ø indicates diameter of fixing holes.



WARNING: It is not recommended for use as a base flange to support guardrail or balustrades (see Type 62).

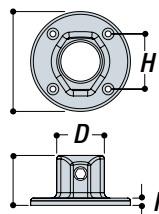

TYPE	Tube ref.	mm						Kg
		A	D	E	F	G	H	
L61-6	6	41	50	8	100	49	6	0.21
L61-7	7	53	55	8	110	61	6	0.29
L61-8	8	60	60	8	120	67	6	0.32

L62 Standard Railing Flange

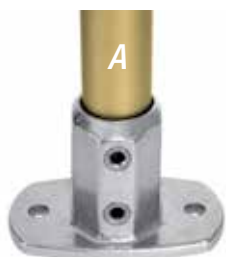

The Type L62 flange should always be used to fix down guardrail and balustrades. Holes are of sufficient diameter to give a good fixing with either a mechanical or chemical anchor. Two set screws in the vertical socket give greater stability to the upright. It is recommended that the fixing holes in the flange be in-line with the applied load. The tube is able to pass through the base of the fitting. \emptyset indicates diameter of fixing holes.

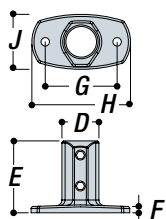

TYPE	Tube ref.	mm								Kg
		A	D	E	F	G	H	J	\emptyset	
L62-6	6	42	90	9	89	128	75	14	0.35	
L62-7	7	55	90	9	102	140	82	14	0.43	
L62-8	8	62	90	9	115	160	84	14	0.47	

L67-8 Angle Flange



Type L67 has been designed to allow the upright to pivot in the barrel, providing an angular displacement from 3° up to a maximum of 11° , measured from the vertical. Ideal to secure balustrade and guardrail systems on access ramps or other types of slopes. \emptyset indicates the diameter of the fixing hole.

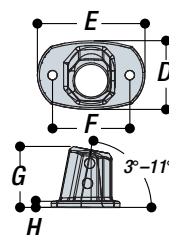

TYPE	Tube ref.	mm							Kg
		A	D	E	F	G	H	\emptyset	
L67-8	8	102	160	115	90	9	14	0.58	

L63-8 Angle Base Flange

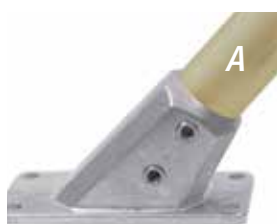

Similar to a Type L62, but used to set up the upright at an angle between 45° to 60° . This fitting should only be subjected to light loads which cannot be positioned at 90° to the applied loads. For greater loads or other tube sizes, a type L62 flange is used and the upright bent to the required angle. \emptyset indicates the diameter of the fixing hole.

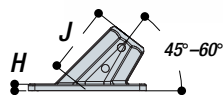

TYPE	Tube ref.	mm								Kg
		A	D	E	F	G	H	J	\emptyset	
L63-8	8	84	180	58	154	10	91	12	0.69	

L68 Wall Flange

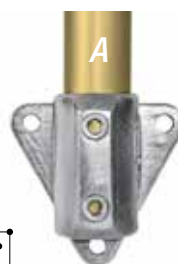

Side palm flange for fixing guardrail and balustrades to walls, parapets, steps and ramps. The upright cannot drop through the socket. \emptyset indicates diameter of fixing holes.

Note: If the upright is required to pass through the fitting by machining out the base stop, the bottom fixing hole becomes unusable.

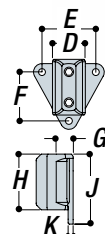

TYPE	Tube ref.	mm								Kg
		A	D	E	F	G	H	J	K	
L68-6	6	42	71	64	24	75	101	8	11	0.24
L68-7	7	53	86	80	28	89	113	8	11	0.35
L68-8	8	60	96	92	31	100	128	8	11	0.43

L69 Railing Flange with Toeboard Adaptor



The L69 railing flange has been designed for guardrail and balustrades and allows attachment of a toeboard to the base. The base plate holes are of sufficient diameter to allow for attachment with either a mechanical or chemical anchor; the side plates have slotted holes to allow for a degree of sideways movement for ease of installation. A toeboard designed for use with Type L69 railing flange is available from **KEE SAFETY**. (See page 36.) \emptyset indicates diameter of fixing holes.

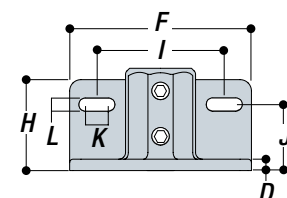
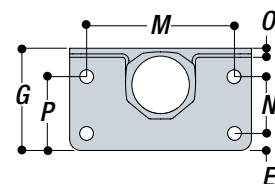

TYPE	Tube ref.	mm														Kg
		A	D	E	F	G	H	I	J	K	L	M	N	O	P	
L69-7	7	10	15	145	80	80	96	58	20	11	115	40	8	51	11	0.64
L69-8	8	10	15	160	90	80	112	58	20	11	130	50	8	57	11	0.75

L70 Rail Support

This fitting, with holes provided for countersunk head screw fixings only, is designed to carry handrails along walls or to fix structures back to walls. The tube passes through the fitting and cannot be joined within the fitting. Type 70 is also used to attach toeboards to the base of guardrail uprights.
 \emptyset indicates diameter of fixing holes.

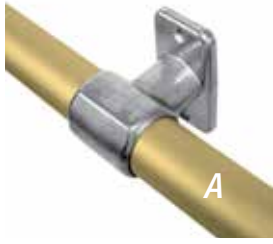

WARNING! Type 70 fittings are not designed to be used as base flanges for full height guardrails or handrails.

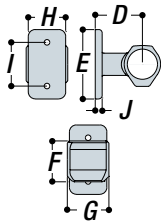

TYPE	Tube ref.	mm								Kg
	A	D	E	F	G	H	I	J	\emptyset	
L70-6	6	60	92	50	50	45	68	10	8	0.20
L70-7	7	68	105	59	60	54	81	10	8	0.34
L70-8	8	75	115	65	66	60	91	10	8	0.45

L148 Heavy Duty Rectangular Flange

Type L148 is a structural base fixing used to fix down guardrail and balustrades. This fitting is available with either two or four fixing holes, which are of sufficient diameter to give a good fixing with either a mechanical or chemical anchor. The two socket set screws give greater stability to the upright. It is recommended that fixing holes be in-line with the applied load.
 \emptyset indicates diameter of fixing holes.

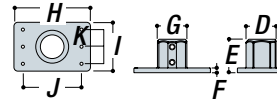

Note: The L148-9/2 has two holes; the L148-9/4 has four holes.

TYPE	Tube ref.	mm								Kg	
	A	D	E	F	G	H	I	J	\emptyset		
L148-9/2	9	78	87	12	77	198	130	153	45	18	1.13
L148-9/4	9	78	87	12	77	198	130	153	45	14	1.13

L84 Metal Plug

A metal drive-in plug. For proper insertion, a rubber mallet should be used. The metal plug is difficult to remove once installed.

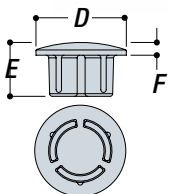

TYPE	Tube ref.	mm			Kg
	A	D	E	F	
L84-6	6	34	31	6	0.02
L84-7	7	43	31	6	0.05
L84-8	8	49	31	6	0.05

L150 Heavy Duty Four Hole Square Flange

A heavy duty, four point fixing flange. Ideal when a structural fixing is required. \emptyset indicates diameter of fixing holes.

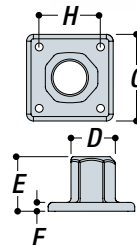

TYPE	Tube ref.	mm						Kg
	A	D	E	F	G	H	\emptyset	
L150-8	8	65	76	13	127	89	11	0.64

L114 Swivel Tee

An internal swivel fitting designed to accommodate varying angles on handrail, staircases, ramps or bracing. Used in conjunction with types L10, L15, L25 or L45, it eliminates the need for specialty drilled angle fittings.

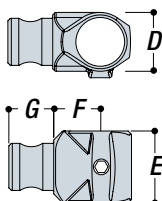

TYPE	Tube ref.	mm					Kg
	A	D	E	F	G		
L114-6	6	43	56	45	32	0.18	
L114-7	7	53	64	43	40	0.27	
L114-8	8	60	70	46	40	0.34	

L152 Four Hole Square Flange

A four point fixing flange. \emptyset indicates diameter of fixing holes.

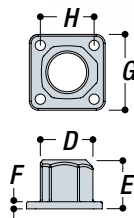

TYPE	Tube ref.	mm						Kg
	A	D	E	F	G	H	\emptyset	
L152-6	6	50	46	6	76	52	8	0.16
L152-7	7	59	55	8	85	61	11	0.27
L152-8	8	65	65	8	92	67	11	0.31

L160 Smooth Handrail Fitting

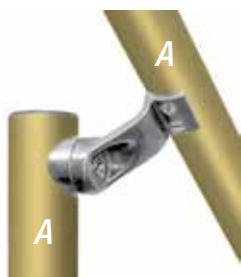

Designed to provide attachment for a smooth handrail. The fitting swivels during installation, allowing the handrail to be placed at any angle. The fitting is supplied as a kit including fasteners.

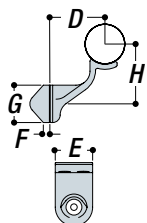

TYPE	Tube ref.	mm					Kg
	A	D	E	F	G	H	
L160-7	7	59	40	10	40	64	0.11
L160-8	8	59	40	8	40	67	0.14

Neoprene Gaskets

Gaskets are available to prevent the corrosion associated with lime in concrete. The gaskets have more resistance than natural rubber to sunlight, ozone and oxidation. Neoprene is heat resistant and does not soften as natural rubber does under severe exposure. Gasket part numbers correspond to **KEE LITE** flange and base components as follows:



LG58	LG61-8	LG62-8	LG68-8	LG70-6	LG148-9	LG152-7
LG61-6	LG62-6	LG68-6	LG69-7	LG70-7	LG150-8	LG152-8
LG61-7	LG62-7	LG68-7	LG69-8	LG70-8	LG152-6	LG164-8

L164 Offset Wall Flange



This component is designed for palm fixing of uprights to steel channels, walls, parapets, steps and ramps. The upright cannot drop through the socket. \emptyset indicates diameter of fixing holes.

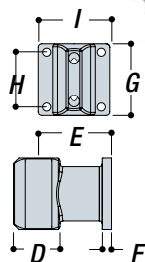

TYPE	Tube ref.	mm							Kg
	A	D	E	F	G	H	I	\emptyset	
L164-8	8	65	102	13	102	76	102	11	0.85



The **KEE ACCESS** range of tubular fittings is designed specifically to meet the requirements of the Equality Act 2010, the Building Regulations Part M and British Standard BS 8300. The **KEE ACCESS** components provide a cost-effective solution for handrail installations on both new and refurbishment projects.

KEE ACCESS components have been designed to give a smooth handrail with size 7 tube (outside diameter 42.4mm). All fittings can be powder coated in a choice of RAL colours to meet the visibility and 'not cold to the touch' requirements of the building regulations.

KEE ACCESS is ideal for creating new barriers, but the system can also be used as a retrofit solution, due to its add-on components which allow a new handrail to be added on to existing railing systems.

Engineering

The modular **KEE ACCESS** components are designed to suit BS EN 10255 (ISO 65) steel tubes. Components are made of galvanised cast iron to BS EN ISO 1461 for long-term maintenance; they are also available with polyester coating in any RAL colour. Any **KEE ACCESS** Railing System can be easily installed with a hex tool and tube cutters, and is therefore easily assembled without specialised workers or equipment, saving you both time and money.

KEE SAFETY has a solution for every environment and situation. **KEE KLAMP** components can be implemented alongside **KEE ACCESS** components to create a complete line of complementary galvanised components. Send us your drawings, sketches or layout for a complete detailed proposal.



Fittings by Function

Coupling

514-7.....Internal

Elbows

515-790° Split
 520-790° Solid
 554-7Variable Angle
 565-7Wall Mounted End Return
 567-7End Post Handrail Return

Handrail Wall Bracket

518-7Galvanised Inset
 561-7Wall
 565-7Wall Mounted End Return
 570-7Galvanised Mounted
 575-7Upright Mounted Handrail Joiner
 580-7Wall Mounted Handrail Joiner

Tees/Sockets

A10-748Add-on Single Handrail (32mm)
 10-840C.....Single Handrail Capped
 10-848.....Single Handrail
 A10-848.....Add-on Split Single Handrail (38mm)
 26-840.....Twin Handrail
 26-840CTwin Handrail Capped
 555-8Top Fix Rail Assembly

Miscellaneous

84-848.....Upright Top Cap
 508-7Gap Washer

KEE ACCESS Basic Assembly

How these components work together to give you the most durable and flexible compliant railing system for access.

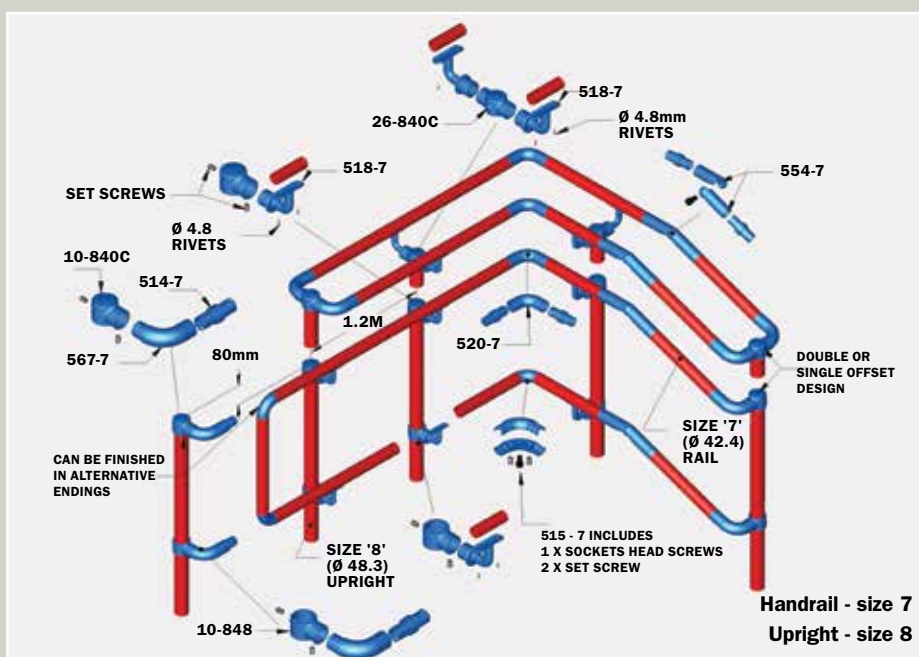

A10-748 Add-on Single Handrail Socket



The unique "hinge and pin" system of this socket tee enables existing structures to be easily modified without the need for dismantling. Hinges around existing size 7, or 32mm N.B. tube.

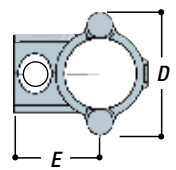

TYPE	Tube ref.		mm		Kg
	A	B	D	E	
A10-748	7	stub	76	53	0.53

A10-848 Add-on Single Handrail Socket



The unique "hinge and pin" system of this socket tee enables existing structures to be easily modified without the need for dismantling. Hinges around existing size 8, or 40 N.B. tube.

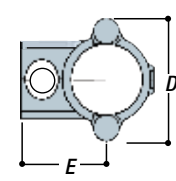

TYPE	Tube ref.		mm		Kg
	A	B	D	E	
A10-848	8	stub	82	55	0.62

10-840C Single Handrail Socket Capped



Capped 90° socket tee designed for use at the termination of an upright where a handrail socket needs to be joined.

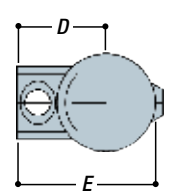

TYPE	Tube ref.		mm		Kg
	A	B	D	E	
10-840C	8	stub	55	85	0.41

26-840 Twin Handrail Socket

Fitting slips over upright to create two handrail sockets at 90°.

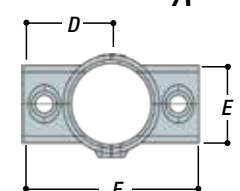

TYPE	Tube ref.		mm			Kg
	A	B	D	E	F	
26-840	8	stub	55	48	110	0.44

10-848 Single Handrail Socket



A 'tee' component used for new builds as an interface between uprights and the KEE ACCESS fittings. For upgrading size 7 and size 8 systems see A10-748 and A10-848.

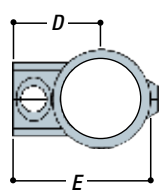

TYPE	Tube ref.		mm		Kg
	A	B	D	E	
10-848	8	stub	55	85	0.38

26-840C Twin Handrail Socket Capped

Capped fitting for use at the termination of an upright to create two handrail sockets at 90° from the upright.

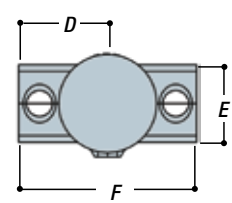

TYPE	Tube ref.		mm			Kg
	A	B	D	E	F	
26-840C	8	stub	55	48	110	0.50

84-848 Upright Top Cap

A metal drive-in plug which is difficult to remove when installed. The 84-848 is a cap for the open ends of size 8 uprights and covers the top of a 10-848 tee fitting. **KEE KLAMP** Types 77-7, 77-8, 84-7 or 84-8 could also be used, but do only cap the tube, not the tube as well as the component. This fitting can only be used with EN 10255 Medium Tube.



A

515-7 Split Elbow (90°)

A 90° corner elbow consisting of two separate pieces, which are joined by a centrally positioned screw. The combined fitting is positioned with the ends inside the adjoining handrails, and the outer grub screws tightened. This forces the halves apart, gripping the inside of the tube. The central screw is then tightened, locking the fitting in place.



A

A

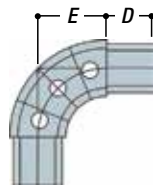

TYPE	Tube ref.	mm		Kg
		D	E	
515-7	A 7	34	50	0.84

508-7 Optional Gap Washer

A rubber gasket for use with size 7 components. Comes only in black.



514-7 Internal Coupling

Designed especially for DDA railing, this internal coupling can be powder coated (unlike our Type 18 fitting). The inset hex screw and precise coupling design allows handrail to be smooth and continuous. The internal coupling is a necessary component when installing Type 520-7, Type 554-7, Type 565-7 and Type 567-7.



A

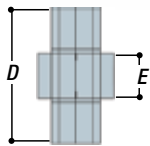

TYPE	Tube ref.	mm		Kg
		D	E	
514-7	A 7	74	25	0.38

518-7 Handrail Bracket

An intermediate upright handrail support. This bracket is designed to be mounted on a Type 10-848, 10-848C, 26-840 and 26-840C or a Type A10 fitting; the rail sits on the saddle and is secured by either Ø4.8mm x 15mm long aluminium 'multi-grip' pop rivets or No. 10 x 20mm countersunk self-tapping screws. Ø indicates diameter of rivet holes.



A

B

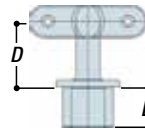

TYPE	Tube ref.		mm			Kg
	A	B	D	E	Ø	
518-7	7	socket	51	30	5	0.49

520-7 Solid Elbow (90°)

An alternative elbow to Type 515, two piece fitting. The elbow is designed to be joined to the handrails using two Type 514-7 internal couplings.



A

A

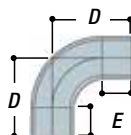

TYPE	Tube ref.	mm		Kg
		D	E	
520-7	A 7	80	30	0.40

554-7 Variable Angle

A variable angle elbow for changes in elevation. This elbow allow for flexibility within particular designs or plans. The elbow is joined to rails using two Type 514-7 internal couplings.

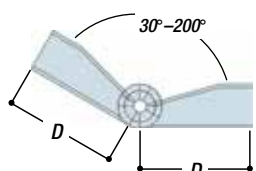

TYPE	Tube ref.	mm			Kg
	A	D			
554-7	7	108			0.33

565-7 Wall Mounted End Return

A wall mounted handrail return bracket. Bracket is joined to handrail using Type 514-7 coupling. Three fixing holes are drilled and countersunk to suit No. 14 csk screws. Ø indicates diameter of fixing holes.

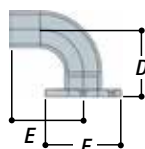

TYPE	Tube ref.	mm					Kg
	A	D	E	F	Ø		
565-7	7	82	86	90	7	0.67	

555-8 Top Fix Rail Assembly

Is an in-line, adjustable angle, single top-rail mounted component for use where a guidance handrail is required and where there is no need for a twin-rail guardrail style system. Saddle has a variable angle of 60° from the vertical. Ø indicates diameter of rivet holes.

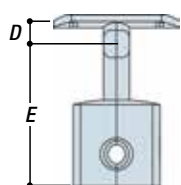

TYPE	Tube ref.		mm			Kg
	A	B	D	E	Ø	
555-8	8	7	13	89	5	0.50

567-7 End Post Handrail Return

A handrail return bracket for use when mounting railing to an upright. This handrail is mounted to an upright using a handrail socket. Join the return handrail using Type 514-7 internal coupling.

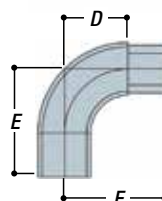

TYPE	Tube ref.	mm				Kg
	A B	D	E	F	Ø	
567-7	7 stub	51	86	81	7	0.57

561-7 Wall Flange

A wall mounted hand rail end flange. Four fixing holes are drilled and countersunk to suit 6mm diameter flat head wood screws. Joins to rail with Type 514-7 Internal Coupling. Ø indicates diameter of fixing holes.

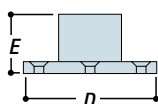
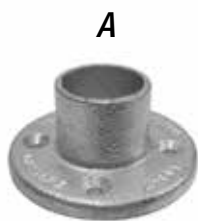

TYPE	Tube ref.	mm			Kg
	A	D	E	Ø	
561-7	7	90	40	7	0.35

570-7 Wall Mounted Handrail Bracket

A wall mounted version of the 518-7. The handrail tube sits on the 'saddle' and is secured using either No. 10 self-drilling screws or multi-grip pop rivets. This bracket provides holes for countersunk head fixing screws only. Three fixing holes are drilled and countersunk to suit 6mm diameter csk screws. Ø indicates diameter of fixing holes.

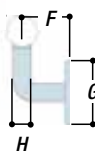
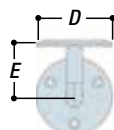

TYPE	Tube ref.	mm						Kg
	A	D	E	F	G	H	Ø	
570-7	7	88	63	82	90	25	7	0.67

575-7 Upright Mounted Handrail Joiner



This bracket is designed to be mounted on a type 10-848, 26-840 or an A10-848 connecting two adjoining tubes without requiring pop rivets or self tapping screws. The inset setscrew and precise coupling design facilitates a smooth and continuous finished handrail.

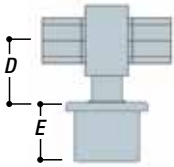

TYPE	Tube ref.	mm		Kg
	A	D	E	
575-7	7	51	30	0.79

580-7 Wall Mounted Handrail Joiner



A wall mounted version of the 575-7, comprises of three countersunk woodscrew fixing holes and connects two adjoining handrail tubes without requiring pop rivets or self tapping screws. The inset setscrew and precise coupling design facilitates a smooth and continuous finished handrail.

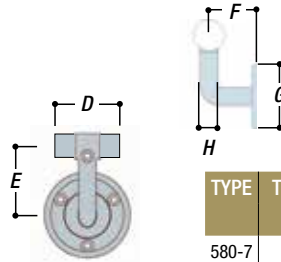

TYPE	Tube ref.	mm					Kg
	A	D	E	F	G	H	
580-7	7	75	84	82	90	25	0.99





99 Hex Key

Simple hex key. A/F refers to the dimension across the flats.

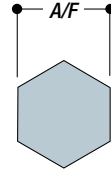

TYPE	To suit tube sizes			A/F
99-3	3			5/32"
99-4	4			3/16"
99-56	5	6		1/4"
99-789	7	8	9	5/16"

97 Set Screws

Socket set screws are supplied and inserted in all **Kee Safety** fittings as standard, the case hardened set screws that are fitted to **KEE KLAMP** and **KEE ACCESS** components are coated with **KEE KOAT**. This unique **Kee Safety** product ensures at least four times the corrosion resistance of bright zinc plated alternatives. **KEE LITE** components are all supplied and fitted with grade 1.4301 Stainless Steel set screws.



TYPE	To suit tube sizes			Size	Finish
97-3	3			5/16" BSF	BZP
97-4	4			3/8" BSF	BZP
97-56	5	6		ISO 228 1/4"	KEE KOAT
97-789	7	8	9	ISO 228 3/8"	KEE KOAT
97-56050	5	6		ISO 228 1/4"	Grade 1.4301 Stainless Steel
97-78950	7	8	9	ISO 228 3/8"	Grade 1.4301 Stainless Steel

97ATD Anti-theft Device

Aluminum drive rivets discourages the tampering of set screws whilst creating a nice finished appearance. Drive rivets are easy to install, the rivet pin is simply hit with a hammer driving it flush with the rivet head and expanding the rear of the rivet. No special tools are necessary.



One size fits components 5-9.

98 Ratchet Set

Reversible ratchet for easier fastening of grub screws (1/2" Drive, 20cm long). Ratchet Handle and Hexagon Bits are supplied separately. A/F refers to the dimensions across the flats.

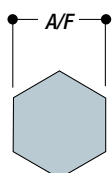

TYPE	To suit tube sizes			Sizes
98				Ratchet Handle (1/2" drive, 8" long)
98-56	5	6		Hexagon Bit (1/4" AF)
98-789	7	8	9	Hexagon Bit (5/16" AF)

TB1 Toeboard

Used with fitting Type L69 Railing Flange. The toeboard is 102mm high and is made of aluminium. A channel in the toeboard accepts the bolt head of the mounting hardware, allowing ease in placement. Toeboard is sold by the linear metre. It can be supplied adonised if required. Mounting hardware is available separately.



In-fill Panels

Panels in a variety of materials, sizes and finishes. The standard 50mm x 50mm Weld Mesh is available in either Galvanised or Powder Coated finish. Maximum panel size is 240cm x 120cm. Smaller opening are also available (25mm x 25mm or 50mm x 50mm).

KEE SAFETY also offer made-to-order Vertical Bar Infill which is stronger than welded mesh and is normally fabricated from 12mm solid bar welded at 100mm centres. This complies with the 100mm sphere rule stated in BS 6180:1995, Clause 5.3. Perforated or solid infill is also available.



Modules

Preassembled modules make for a simple and quick assembly or installation of your project. Provides constant barrier heights and lengths. Made to suit individual project requirements. A standard set is also available.



Meet every
Safety Loading Standard
up to 1500 Newtons per Metre (N/m)
in practically every location

Simple to Design and Specify

The modular **KEE SAFETY** systems securely join standard sizes of structural tube in almost any configuration you can imagine.

Assembled on site, **KEE SAFETY** guardrailing will accommodate most variations between design drawings and site requirements.

Cost-Effective to Install

Low skill, no welding, no special tools required. All components slip over tube, and can be adjusted to the required level and positioned before tightening with a simple hex key.

Widest Range of Components for Structural Tube

Just sketch out the guardrail you want to construct and check the fittings you require. Combination fittings optimise the strength to weight ratio and cost of any structure, enabling different diameters of tube to be used.

Meet Specified Loadings up to 1500 N/m

Use the Loading Tables on page 40 to select the appropriate tube size, grade, and the 'bay size' for the guardrailing uprights. The same design loading can be achieved by using either stronger uprights and wider bays, or lighter uprights set closer together.

Unrivalled Technical Support

KEE SAFETY offer practical assistance over the telephone or by fax, or, if required, will check your designs or drawings for compliance with current Safety Standards.

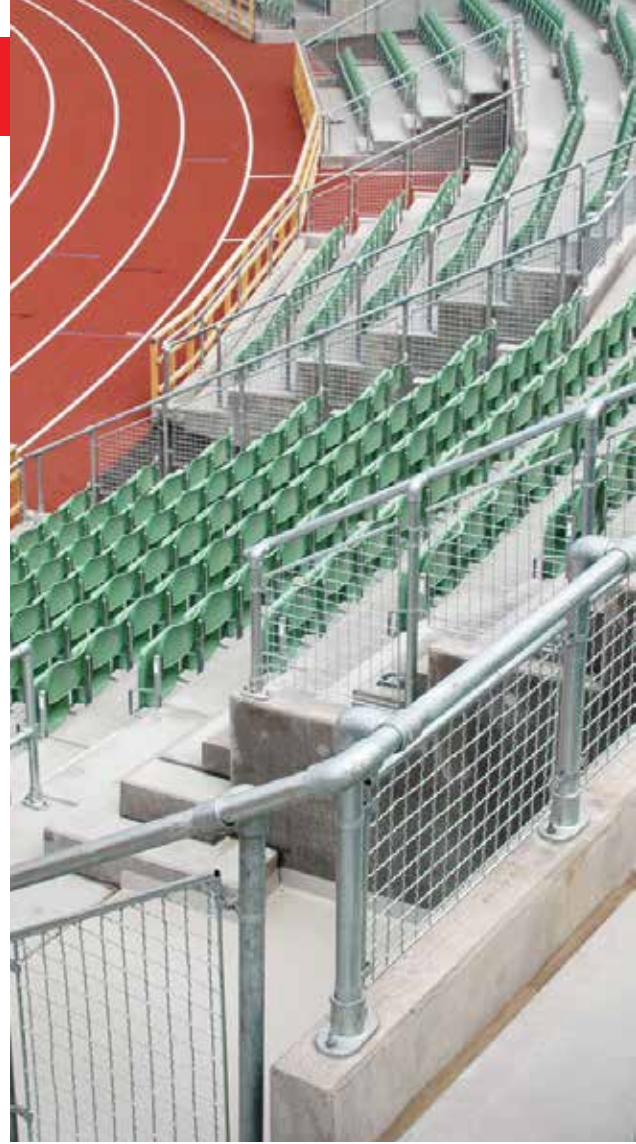

Kee Safety Technical Support

Tel: +44 (0) 1384 632 188

Fax: +44 (0) 1384 632 192

Email: sales@keesafety.com

www.keesafety.co.uk

LEVEL

The universal guardrailling solution.

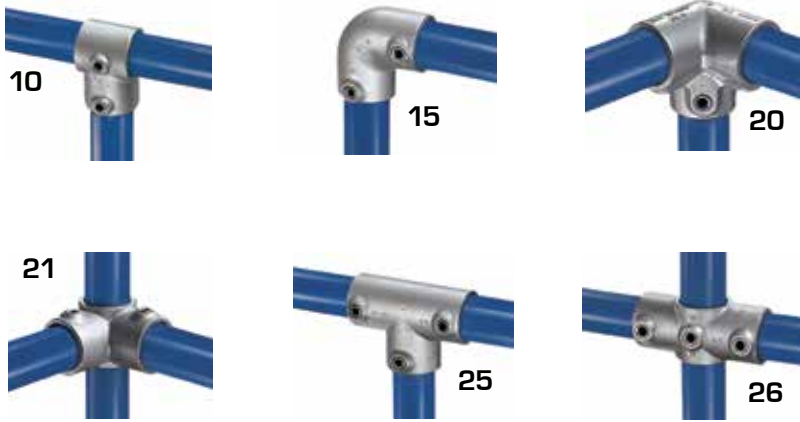

RAMPS

Unique 0° to 11° range for in-line construction. Non-handed fittings allow consistent alignment of grubscrews.

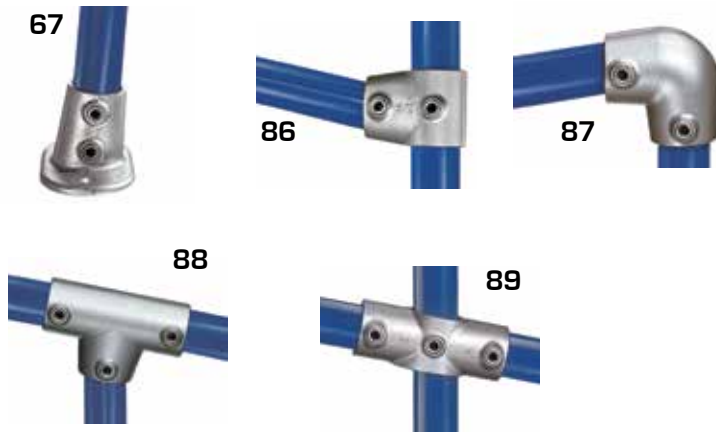

STAIRS

Maximum strength. Minimum installation time and cost.

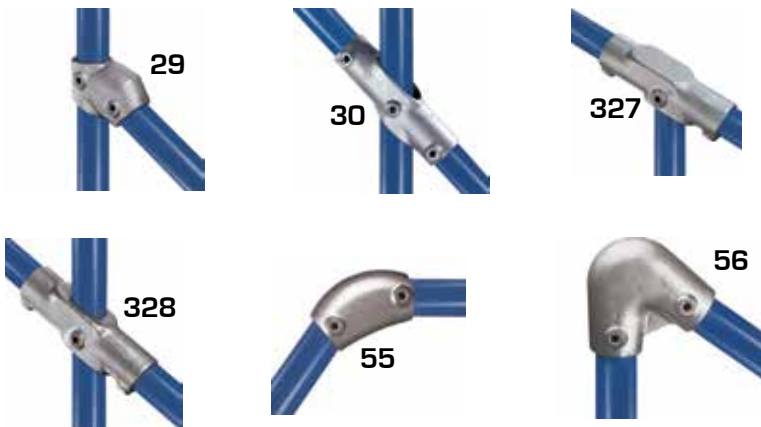

PEDESTRIAN GUARDRAILING

Complies with BS 7818 Clause 2.4. Each railing is individually replaceable offering large cost savings when repair is necessary.

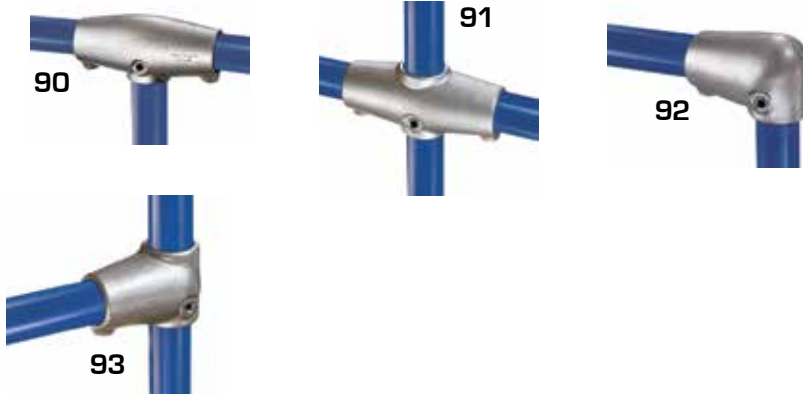

SLOPE FITTINGS

For building a guardrail along staircases and ramps when the slope is greater than 30°

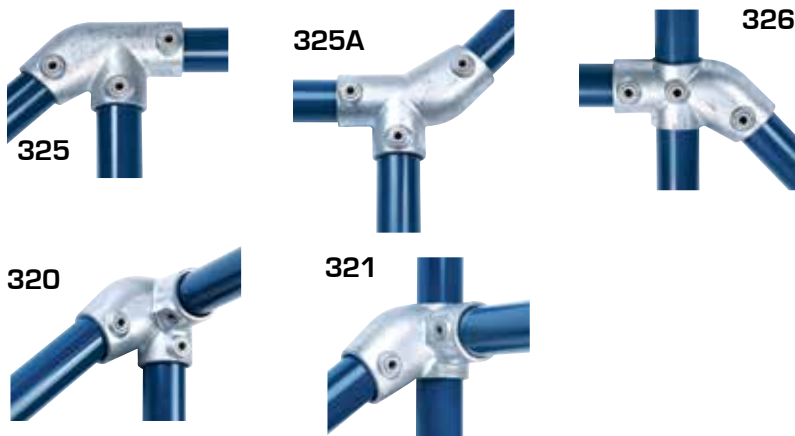

SLOPE FITTINGS

Single fittings for slopes greater than 30°



360 Newtons per metre run (N/m) Industrial Use-Non Emergency
 740 Newtons per metre run (N/m) Commercial Use
 1500 Newtons per metre run (N/m) Retail/Public Access

The current regulations give various design requirements to be fulfilled of which the Design Load is the most important.

Kee Klamp Load Chart

Tube Size	6 3.2mm	7 3.2mm	7 4mm	8 3.2mm	8 4mm	8 5mm	9 3.65mm	9 4.5mm
Grade	BS EN 10255 Medium	BS EN 10255 Medium	BS EN 10255 Heavy	BS EN 10255 Medium	BS EN 39	EN 10210 S355 JOH	BS EN 10255 Medium	BS EN 10255 Heavy
Design Load Criteria	Upright Height 900mm							
360 N/m	814mm (4.44KN)	1369mm (6.52KN)	1595mm (7.60KN)	1828mm (7.73KN)	2584mm (10.92KN)	3052mm (12.90KN)	3265mm (13.80KN)	3856mm (14.75KN)
740 N/m	396mm (4.44KN)	666mm (6.52KN)	776mm (7.60KN)	889mm (7.73KN)	1257mm (10.92KN)	2229mm (19.36KN)	1588mm (13.80KN)	1876mm (14.75KN)
1500 N/m	195mm (4.44KN)	329mm (6.52KN)	383mm (7.60KN)	439mm (7.73KN)	620mm (10.92KN)	1100mm (19.36KN)	784mm (13.80KN)	925mm (14.75KN)
Design Load Criteria	Upright Height 1000mm							
360 N/m	732mm (4.44KN)	1232mm (6.52KN)	1435mm (7.60KN)	1645mm (7.73KN)	2326mm (10.92KN)	2930mm (13.76KN)	2939mm (13.80KN)	3470mm (14.75KN)
740 N/m	356mm (4.44KN)	599mm (6.52KN)	698mm (7.60KN)	800mm (7.73KN)	1131mm (10.92KN)	2006mm (19.36KN)	1430mm (13.80KN)	1688mm (14.75KN)
1500 N/m	176mm (4.44KN)	296mm (6.52 KN)	345mm (7.60KN)	395mm (7.73KN)	558mm (10.92KN)	990mm (19.36 KN)	705mm (13.80 KN)	833mm (14.75 KN)
Design Load Criteria	Upright Height 1100mm							
360 N/m	666mm (4.44KN)	1120mm (6.52KN)	1305mm (7.60KN)	1496mm (7.73KN)	2114mm (10.92KN)	2778mm (14.35KN)	2671mm (13.80KN)	3155mm (14.75KN)
740 N/m	324mm (4.44KN)	545mm (6.52KN)	635mm (7.60KN)	728mm (7.73KN)	1028mm (10.92KN)	1824mm (19.36KN)	1300mm (13.80KN)	1535mm (14.75KN)
1500 N/m	160mm (4.44KN)	269mm (6.52KN)	313mm (7.60KN)	359mm (7.73KN)	507mm (10.92KN)	900mm (19.36KN)	641mm (13.80KN)	757mm (14.75KN)

Base upon rail diameter being the same as the upright but using BS EN 10255 medium wall tubing.

Design Loads are as stated in BS 8118, BS 6180, BS 6399 & BS 7818.

The above bay sizes are based upon using the **KEE KLAMP** Type 62 base fitting fixed perpendicular to the line of the handrails.

The figures shown in brackets are the required anchor pull out loads for the bay size indicated after all reduction factors have been applied.

Kee Lite Load Chart

Tube Size	6 3.38mm	7 3.56mm	8 4.05mm	9 4.06mm
Grade	6082 T6	6082 T6	6082 T6	6082 T6
Design Load Criteria	Upright Height 900mm			
360 N/m	720mm	1388mm	1879mm	2490mm
740 N/m	N/A	N/A	1220mm	1940mm
Design Load Criteria	Upright Height 1000mm			
360 N/m	540mm	1117mm	1664mm	2370mm
740 N/m	N/A	N/A	950mm	1690mm
Design Load Criteria	Upright Height 1100mm			
360 N/m	400mm	871mm	1398mm	2205mm
740 N/m	N/A	N/A	730mm	1400mm

Notes

- The table is based on the maximum permissible bending moment of the tube
- All rails are the same tube size as uprights but in BS EN 10255 medium grade tube
- Where tube is to be used to form ground sockets:
 - Tube size 6 fits inside tube size 7 medium grade only
 - Tube size 8 fits inside tube size 9 all grades.

Based upon rail diameter being the same size & grades as the upright.

Design Loads are as stated in BS 8118, BS 5950, BS 6180, BS 6399 & BS 7818.

To achieve bigger bay sizes than those stated please contact Kee Safety Ltd for further details.

KEE LITE components are made from high grade Aluminium Silicon Magnesium Alloy.

- Recommended set screw torque is 39Nm
- Minimum slip load capacity on aluminium tube: 7.56KN (safety factor = 2 with tube having a minimum UTS of 275 N/mm²)
- Large grub screws are designed to resist thread stripping
- The core range of **KEE LITE** fittings has undergone independent testing by TÜV.

Straight and Level Guard Rail

Using Types 10, 15, 20, 21, 25, & 26 or L10, L15, L20, L21, L25, & L26

Where:

L = distance between centres of uprights

l = length of horizontal tube

H = distance from ground to centre line of top rail

h = length of upright tube

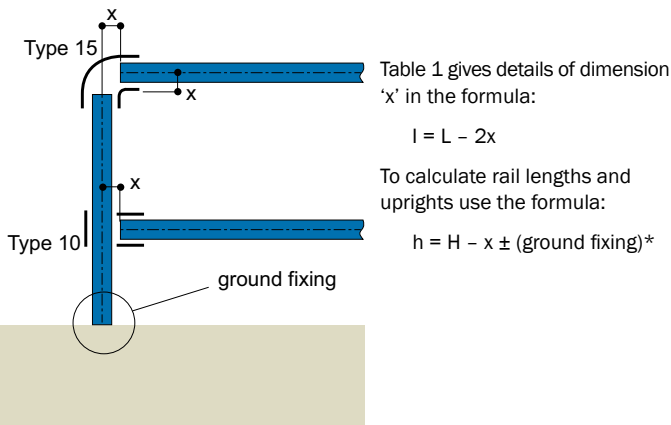
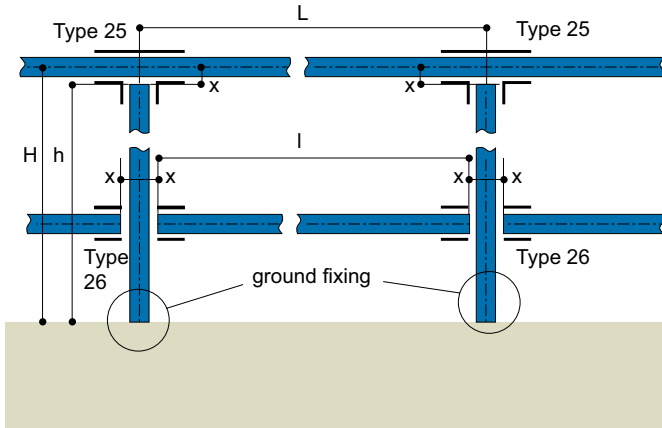

Table 1 gives details of dimension 'x' in the formula:

$$l = L - 2x$$

To calculate rail lengths and uprights use the formula:

$$h = H - x \pm (\text{ground fixing})^*$$

Table 1: Dimension 'x' for fittings shown above, including Types 35, 40 and L35*

Fitting Size	x (mm)
3	-12
4	-13
5	-14
6	-17
7	-22
8	-25
9	-30

Note: When reducing fittings are being used care must be taken to use the correct 'x' dimension. (i.e., Type 10-87, vertical tube size 8, horizontal tube size 7. To find the correct length of the horizontal tube, the length 'x' is that for the size 8 vertical tube.)

When using Types 35 and 40 the above 'x' dimension should be used.

Although guardrailing is normally constructed in size 6, 7 and 8 tube, Table 1 shows the cutting length for all **KEE KLAMP** tube sizes, and can therefore be applied to many other rectangular structures.

*When using **KEE LITE** bases, L61, L62, L69, L140, L150 and L152, "ground fixing" dimension will be zero.

Guardrailing up Slopes 0°–11°

Using Types 86, 87, 88 and 89

Where the upright remains vertical, i.e. ramps and stairways, (i) dimension 'x' to be subtracted from the upright centre dimension measured on the slope to give rail length. ($l = L - 2x$); (ii) dimension 'y' to be added to the centre dimension to give the length of the upright ($H = h + y + \text{ground fixing}$).

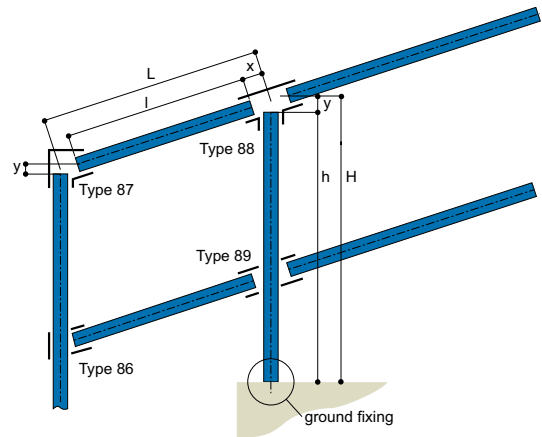

Table 2 gives details of dimensions required for calculating the rail lengths, where angles are between 0° and 11°.

Table 2: Rails

Angle of Slope	Size 8 Fittings 'x' (mm)
0° to 4°	-25
5° to 9°	-28
10° to 11°	-30

Table 3 gives details of dimensions required for calculating the upright lengths, where angles are between 0° and 11°.

Table 3: Uprights

Angle of Slope	Size 8 Fittings 'y' (mm)
0° to 4°	-25
5° to 9°	-28
10° to 11°	-30

Guardrail Up Slopes 11° to 30°

Using Types 55A, 56A, 327, 328, & 329 size 7 & 8

Where the upright remains vertical, i.e. stairways (i) dimension x, x1, x2, x3 to be subtracted from the upright centres; dimension (L) to give the rail length; (ii) dimension y, y1 and y2 for determining the up-right length.

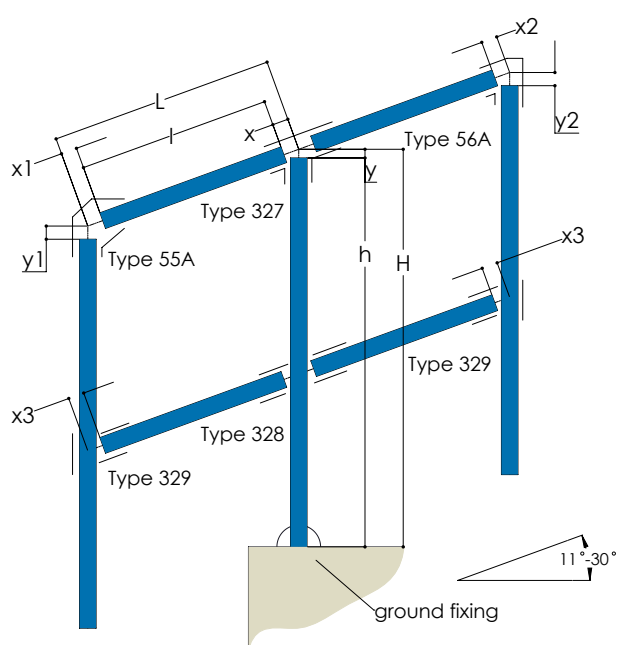

Table 1 gives details of dimensions required for calculating the rail lengths, where angle are between 11° & 30°

Table 1: Rails

Angle Of Slope	Fitting Size							
	7				8			
	x	x1	x2	x3	x	x1	x2	x3
11°	-26	-25	-35	-52	-29	-16	-35	-51
15°	-28	-21	-46	-53	-31	-27	-47	-52
20°	-30	-16	-48	-55	-34	-21	-49	-54
25°	-33	-15	-52	-59	-38	-22	-53	-57
30°	-37	-8	-57	-64	-42	-15	-59	-62

Table 2 Gives details of dimensions required for calculating the upright lengths.

Table 2: Uprights

Angle Of Slope	Fitting Size					
	7			8		
	y	y1	y2	y	y1	y2
11°	+7	-10	-28	+6	-7	-33
15°	+7	-11	-25	+6	-8	-30
20°	+7	-13	-34	+6	-10	-38
25°	+7	-15	-43	+6	-10	-48
30°	+7	-18	-53	+6	-14	-59

Guardrail up Slopes 30° to 45°

Using Types 29, 30, 55, 56 & 427 in sizes 7 & 8

Where the upright remains vertical, i.e. stairways (i) dimension x, x1, x3, y & z to be subtracted from the upright centres; dimension (L) to give the rail length; (ii) dimension u, v and w for determining the upright length.

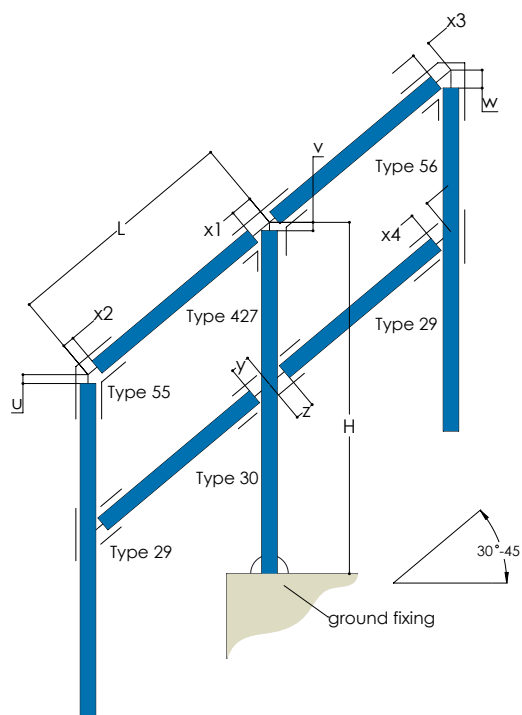

Table 3 gives details of dimensions required for calculating the rail lengths, where angle are between 30° & 45°

Table 3: Rails

Angle Of Slope	Fitting Size											
	7						8					
	x1	x2	x3	x4	y	z	x1	x2	x3	x4	y	z
30°	-39	-20	-55	-37	-49	-55	-45	-22	-49	-43	-60	-74
35°	-44	-16	-61	-40	-50	-54	-50	-18	-55	-47	-60	-74
40°	-47	-20	-71	-45	-51	-53	-55	-21	-66	-52	-61	-74
45°	-50	-26	-85	-51	-91	-53	-55	-26	-81	-59	-68	-66

Table 4 Gives details of dimensions required for calculating the upright lengths..

Table 4: Uprights

Angle Of Slope	Fitting Size					
	7			8		
	u	v	w	u	v	w
30°	-17	+5	-48	-25	+6	-49
35°	-16	+5	-59	-21	+6	-59
40°	-8	+3	-69	-14	+6	-69
45°	+2	-1	-80	-2	-4	-81

Guardrail up slopes 30° to 45° Using 325, 325A, 326, size 7 & 8

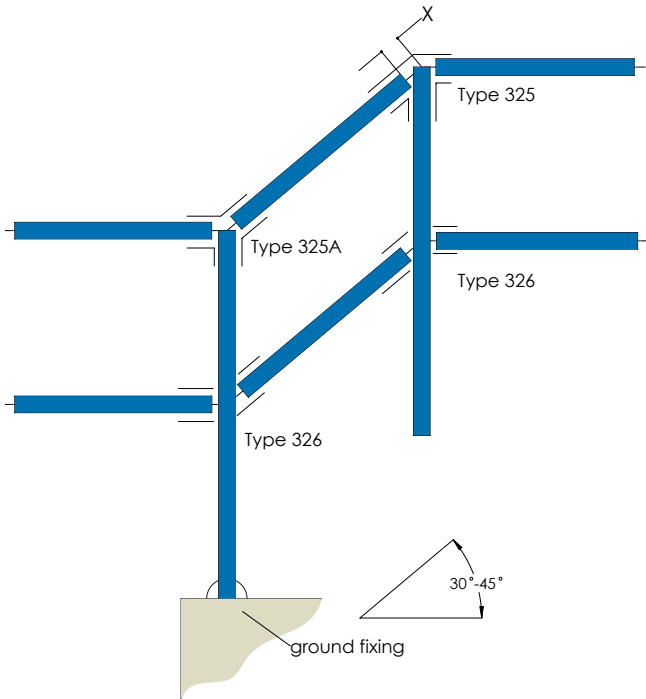

Guardrail up slopes 30° to 45° Using 320RH, 320LH, 321RH & 321LH size 7 and 8

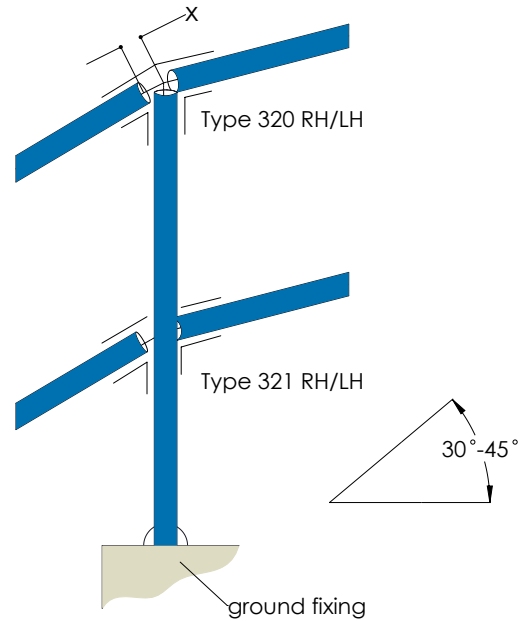

Table 5 gives details of dimensions required for calculating the rail lengths, where angle are between 30° & 45°

Table 6 gives details of dimensions required for calculating the rail lengths, where angle are between 30° & 45°

Table 5: Rails

Angle Of Slope	Fitting Size	
	7	8
	x	x
30°	-47	-57
35°	-52	-62
40°	-59	-69
45°	-68	-79

Table 6: Rails

Angle Of Slope	Fitting Size	
	7	8
	x	x
30°	-55	-62
35°	-60	-68
40°	-67	-76
45°	-77	-86

New Slope Fittings

The latest addition to the **KEE KLAMP** portfolio is an extension to the current range of slope fittings designed to enhance the building of guardrail along staircases and ramps particularly when the slope is greater than 30°. The new range introduces single fittings to cater for situations where currently a combination of fittings is required. Not only does this improve the aesthetics of the finished guardrail but it also allows for a quicker and easier install. The new range of slope fittings is available in Size 7 (outer diameter 42.4mm) and Size 8 (outer diameter 48.3mm) designed for use with steel tubing to BS EN 10255.

KEE KLAMP fittings are iron castings manufactured to the requirements of BS EN 1562 & BS EN 1563. They are supplied hot dip galvanised to BS EN ISO 1461.

A **KEE KLAMP** fitting can support an axial load of 900Kg per set screw tightened to a torque of 4Kgm (39 Nm). In common with all **KEE KLAMP** products, the threaded recesses of each fitting are covered with **THREDKOAT** protective coating to provide enhanced corrosion resistance and all grub screws are manufactured in case hardened steel coated with **KEE KOAT** for corrosion protection.

Features & Benefits

- KEE KLAMP is the best known brand of slip-on tube fittings available for over 80 years
- Manufactured to stringent quality standards to ensure consistent performance
- Extended range of slope fittings gives greater design flexibility
- Adjustability in the fittings allows greater on-site tolerances to be met
- Using single fittings rather than pairs speed up installation times

Guardrailing up Slopes 11°–30° Using Adjustable Fittings, Types 327 and 328

Where the upright remains vertical, i.e. ramps and stairways, (i) dimension 'x' to be subtracted from the upright centres dimension measured on the slope to give rail length. ($l = L - 2x$); (ii) dimension 'y' to be added to the centre dimension to give the length of the upright ($h = H + Y + \text{ground fixing}$).

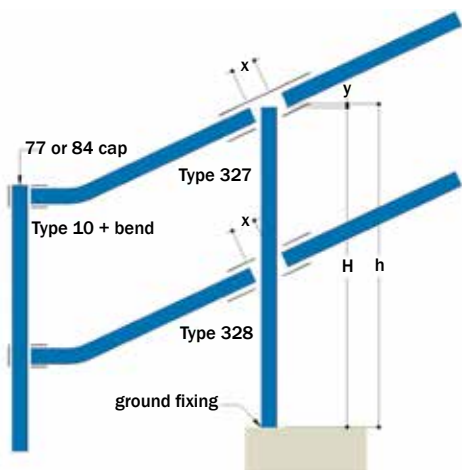

Table 4 gives details of dimensions required for calculating the rail lengths, where angles are between 11° and 30°.

Table 4: Rails

Angle of Slope	Size 7 Fittings: 'x' (mm)	Size 8 Fittings: 'x' (mm)
11°	-28	-30
15°	-32	-35
20°	-32	-38
25°	-35	-41
30°	-41	-44

Table 5 gives details of dimensions required for calculating the upright lengths, where angles are between 11° and 30°.

Table 5: Uprights

Angle of Slope	Size 7 Fittings: 'y' (mm)	Size 8 Fittings: 'y' (mm)
11°	+16	+19
15°	+16	+19
20°	+13	+16
25°	+13	+16
30°	+13	+13

Guardrailing up Slopes 30°–45° Using Adjustable Fittings, Types 29, 30, 55 & 56 or Types L29 & L30 size 6, 7 and 8

Where the upright remains vertical, i.e. stairways (i) dimension x, y, or z to be subtracted from the upright centres: dimension (L), to give the rail length; (ii) dimension u, v and w for determining the upright length.

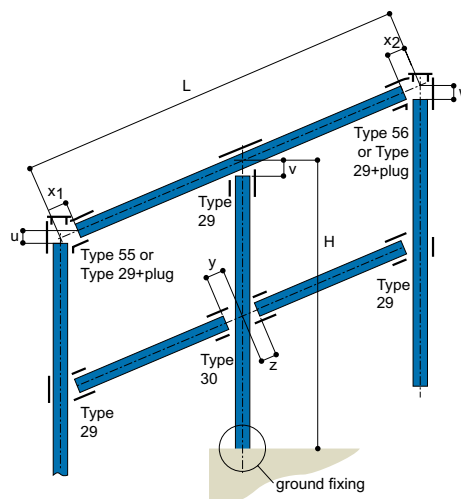

Table 6 gives details of dimensions required for calculating the rail lengths, where angles are between 30° and 45°.

Table 6: Rails

Angle of Slope	Size 6 Fitting			Size 7 Fitting			Size 8 Fitting		
	x (mm)	y (mm)	z (mm)	x (mm)	y (mm)	z (mm)	x (mm)	y (mm)	z (mm)
30°	-31	-54	-36	-40	-64	-41	-45	-77	-54
35°	-34	-51	-39	-44	-61	-44	-50	-73	-57
40°	-37	-48	-42	-48	-57	-48	-55	-64	-61
45°	-43	-45	-45	-54	-53	-52	-61	-65	-66

Table 7 gives details of dimensions required for calculating the upright lengths, where angles are between 30° and 45°.

Table 7: Uprights

Angle of Slope	Size 6 Fitting			Size 7 Fitting			Size 8 Fitting		
	u (mm)	v (mm)	w (mm)	u (mm)	v (mm)	w (mm)	u (mm)	v (mm)	w (mm)
30°	+36	-31	+24	+44	-40	+29	+46	-45	+33
35°	+42	-34	+18	+52	-44	+21	+55	-50	+24
40°	+49	-37	+11	+61	-48	+12	+65	-55	+14
45°	+58	-43	+2	+71	-54	+2	+77	-61	+2

Table 8 gives details of dimensions required for calculating the upright lengths.

Table 8: Uprights and rails using Types 55 and 56 – Size 8 only

Angle	u (mm)	x ₁ (mm)	w (mm)	x ₂ (mm)
20° to 29°	-18	-18	-50	-50
30° to 39°	-16	-16	-60	-60
40° to 49°	-14	-14	-70	-70
50° to 59°	-12	-12	-	-
60° to 69°	-10	-10	-	-
70° to 79°	-8	-8	-	-
80° to 88°	-6	-6	-	-

Shelving

Using Type 46 or L46

Shelving with carrying rails positioned on the outside of the upright.

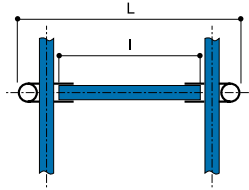

Table 9 gives the dimension 'x' to be subtracted from overall shelf width 'L' to give the length of the cross rail in the formula $l = L - x$. (Dimension x accounts for the use of two Type 46 or L46 fittings.)

Table 9

Fitting Size	x (mm)
4	-98
5	-134
6	-162
7	-196
8	-228
9	-276

Construction of Braces and Struts

Using Types C50, C51, C52 & C53 or LC50, LC51 & LC52

When using multiple tube sizes in one structure, Types F50-5 to F50-9 or LF50-6 to LF50-8 can all be combined with:

M50-5 to M50-9 LM50-6 to LM50-8
M51-5 to M51-9 LM51-6 to LM51-8
M52-5 to M52-8 LM52-6 to LM52-8
M53-8

to construct combination fittings (i.e. C50-75, C50-85, C51-655, C52-855 and C53-888).

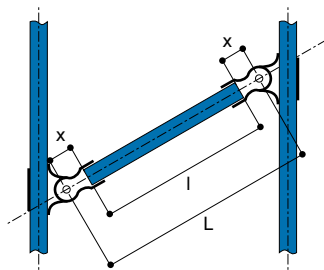

Table 10 gives details of dimension 'x' to be subtracted to give the tube length required for use with two Type F50 or LF50 fittings in the formula $l = L - 2x$.

Table 10

Fitting Size	x (mm)
4	-14
5	-25
6	-25
7	-25
8	-25
9	-32

Note: Dimension 'L' is the length from pivot point to pivot point. The distance from upright to upright is dependent on the angle of the strut.

Pallet Racking

Using Type 46 or L46

Pallet racking with the carrying rails on the inside of the upright.

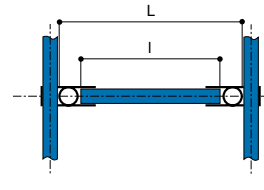

Table 11 gives dimension 'x' which must be subtracted from the overall width of the carrying rails, to give the length of the cross rail in the formula: $l = L - x$. (Dimension x accounts for the use of two Type 46 or L46 fittings.)

Table 11

Fitting Size	x (mm)
4*	-48
5*	-59
6*	-72
7	-85
8	-102
9	-126

*Pallet racking is not recommended in less than size 7 tube.

The length of the longitudinal member can be calculated from multiples of the length of the bay between the centres of uprights, plus dimension 'z' in Table 12. Dimension z accounts for the length of tube needed to go through the topmost fitting to the fitting's termination. This also applies to constructions using fitting Type 45.

Table 12: Additional tube length to reach topmost fitting's termination

Fitting Size	z (mm)
3	+24
4	+28
5	+31
6	+38
7	+46
8	+51
9	+61

Longitudinal tubes are joined using fittings Type 14 or 18 couplings (use of Type 18 is not recommended as a load bearing joint), which must be positioned to occur at the edge of the Type 46 fitting, and must not all occur in the same bay at alternate levels.

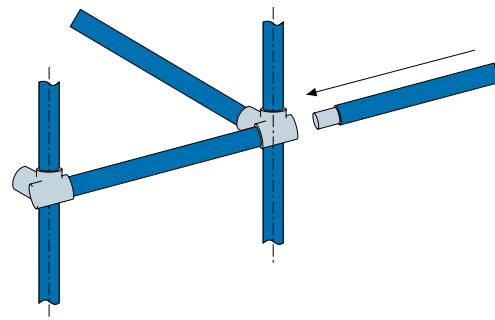

Spigots can be either tubes or rods, riveted into position, or the Type 18 fitting. When using the latter, a gap of 20mm must be allowed for the set screw fixing.

Base and Wall Fixings*

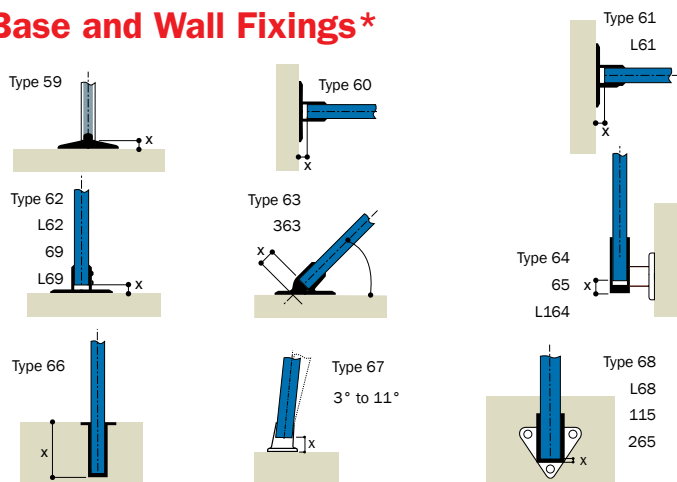

Table 13 gives details of the ground fixing dimension 'x', to be subtracted from the height 'H' to give the length of the upright 'h'.

Table 13

Flange Type	x (mm)
59	-10
60	-10
61	-6
62	-6
67	-6

Table 14 gives details of the ground fixing dimension 'x', for Type 63-6 only, to be subtracted to give the length of the upright for each angle condition.

Table 14

Angle	x (mm)
45°	-38
50°	-32
60°	-25
65°	-12

Table 15 gives details of the ground fixing dimension 'x' for Type 363, to be subtracted to give the length of the upright for each angle condition.

Table 15

Angle	x (mm)
11°	-38
15°	-32
20°	-25
25°	-20
30°	-12

Table 16 gives the dimension 'x' to be subtracted from the length of the upright for fitting Types 64, 65, 67, 68, 115, 265, L68 and L164.

Table 16

Fitting Size	x (mm)
6	-5
7	-6
8	-6

Table 17 gives the ground fixing dimension 'x', to be added to the upright member to allow for the setting into the socket Type 66.

Table 17

Fitting Size	x (mm)
6	+115
7	+127
8	+127

*When using **KEE LITE** bases and flanges, "ground fixing" dimension (x) will be zero, except when using flanges L164, L68 and LC58.

Constructing Circles and Triangles

Slopes and radii present no problem to the **KEE KLAMP** galvanised railing systems. Fitting Types 27, 28, 29, 30, C50, C51, C52, 55, 56, 86, 87, 88 and 89 (and the 90 range pedestrian guardrail fittings) are designed to allow for raked handrail while keeping the uprights vertical. Tube can be bent and radiused to suit most situations. Also, true lengths have to be determined where braces and struts are being used.

Worked Example

Consider the following concrete single flight staircase.

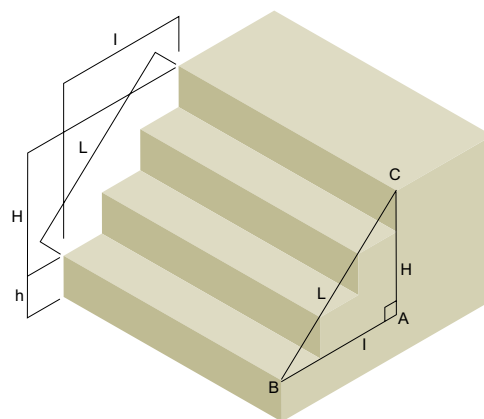

Where

H = Vertical height from 1st nosing to last nosing.

h = Vertical height from ground level to 1st nosing.

I = Horizontal dimension from 1st nosing to last nosing.

L = Hypotenuse dimension (Pitch Line) from 1st nosing to last nosing.

Known Data	Formula for Side and Angle		
H & L	$I = \sqrt{L^2 - H^2}$	$\sin B = \frac{H}{L}$	$C = 90^\circ - B$
L & I	$H = \sqrt{L^2 - I^2}$	$\sin C = \frac{I}{L}$	$B = 90^\circ - C$
H & I	$H = \sqrt{H^2 - I^2}$	$\tan B = \frac{I}{H}$	$C = 90^\circ - B$

Note: The table can be used to solve angles and true lengths for braces and struts.

Step 1

From a simple site survey or information from a working drawing, obtain the following dimensions.

Note: For greater accuracy, vertical dimensions should be taken by means of a Dumpy Level or a Theodolite.

H = vertical height from the 1st nosing to the last (140cm).

L = pitch line, the diagonal dimension from the 1st nosing to the last (240cm).

Step 2

From the table to determine angle B we use;

$\sin B = 55 / 96$, Angle B = 35°

Ramps can be dealt with in a similar way. Most ramps have a stated gradient (e.g. 1:12); for every 12 units traversed horizontally, 1 unit of vertical height is obtained.

How to Make Jigs for Railing Posts Set-up

Step 1: Start with pre-cut tube.

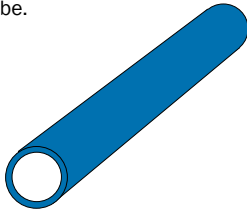

Step 2: Measure and locate fittings on first post only.

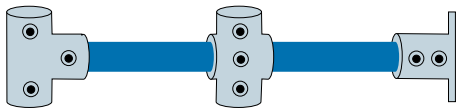

Step 3: Lay post horizontal, and insert two pieces of scrap tube.

This is all that's involved in setting up your jig! From this point, duplicate posts can be produced by unskilled labour, without further measuring, at the rate of 20-30 posts per hour.

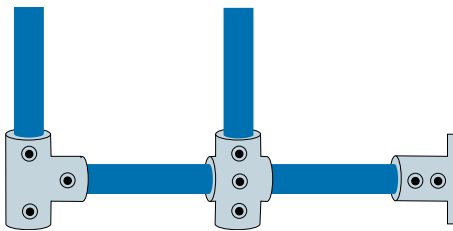

Utilising Jigs for Railing Posts Production

Step 1: Set top and middle fittings in place, unfastened, on the two pieces of scrap pipe.

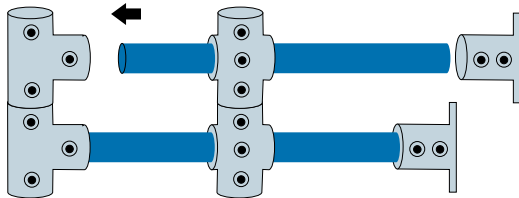

Step 2: Insert pre-cut tube into fittings, then add flange.

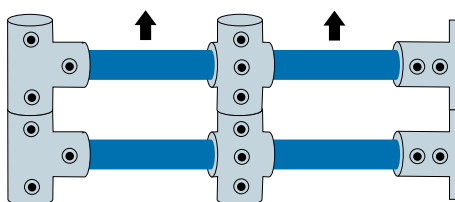

Step 3: Simply tighten set screws, then lift off.

Pedestrian Guardrailing Using Types 90, 91, 92, 93 and 95

This construction is used when individual rails are required to be removable and when the site is not straight and level. Slopes of up to 7° or radii greater than six metres can be accommodated without bending the tubing.

When bending the tube around a corner, a Type 95 PGR spigot must be included to prevent sagging. Holes of 15mm diameter must be drilled through both walls of the upright, one at 25mm from the top of the upright tube.

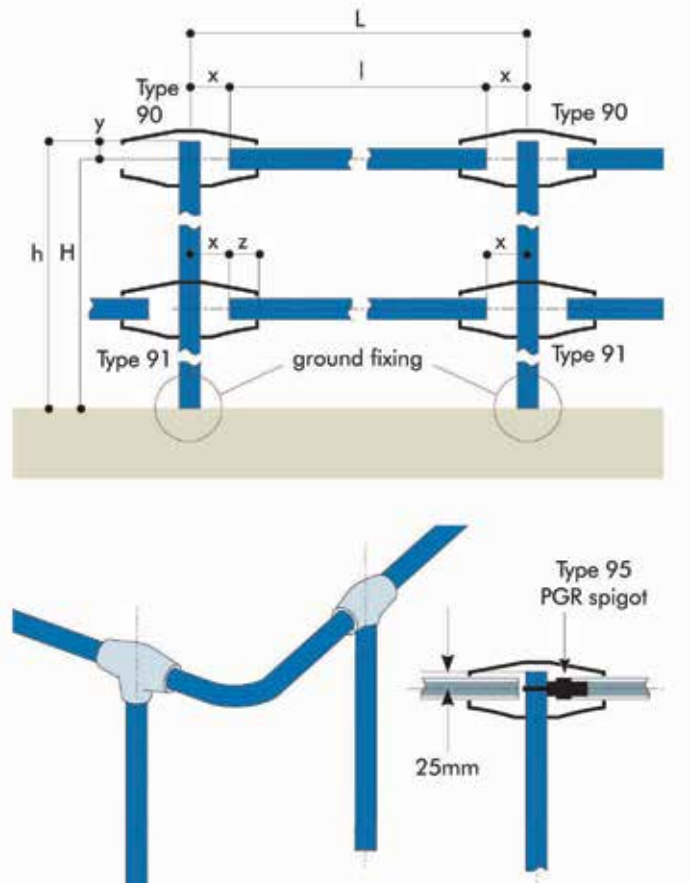

Table 18 gives details of:

(i) Dimension 'x' in the formula $L = L - 2x$ for calculating the rail lengths where:

L = distance between the centres of the uprights

l = length of the horizontal tube.

(ii) Dimension 'y' in the formula $h = H + y + (\text{ground fixing})$ for calculating the upright length where:

H = distance from ground to the centre line of the top rail

h = length of upright tube.

Table 18

Fitting Size	x (mm)	y (mm)
8	-66	+25

A brass drive screw (No. 6 x 10mm) is located at dimension 'z', in Table 19, on one end only for each horizontal tube. This positions the horizontal tube within the **Kee Klamp** fitting to give location relative to the set screws.

Table 19

Fitting Size	z (mm)
8	37

Wire Mesh Infill

Infilling is normally constructed from 50mm x 50mm x 3.2mm, 25mm x 25mm x 3.2mm or 50mm x 25mm x 3.2mm wire mesh welded to a 8mm rod frame, and is fixed into position using standard Fitting Types 81 and 82. (NB: Types 81 and 82 require cut outs on mesh less than 32mm square.)

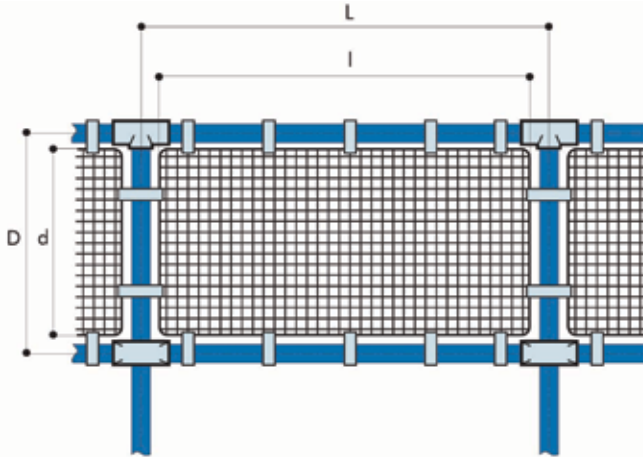

Table 20 gives the dimensions to be subtracted from the centre dimensions 'L' and 'D' of the structure to give the formulae $l = L - x$ and $d = D - x$.

Table 20

Fitting Size	x (mm)
5	-60
6	-76
7	-86
8	-89
9	-98

WARNING: The spacing of panel clip Types 81 and 82 should not exceed 450mm centres. The safety attachment incorporated in the panel clip Types 81 and 82 cannot be used with mesh less than 32mm.

Tube Bending

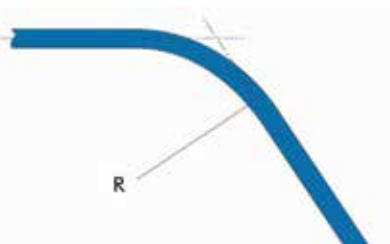

Table 21 gives details of standard radius 'R' of the tube bent by Kee Safety Ltd. If the standard radii below are not suitable, tube sizes 5 to 9 can be rolled to any radius above a minimum of 500mm.

Table 21

Fitting Size	R (mm)
3	57
4	57
5	90 or 98
6	102
7	135
8	152
9	203



Galvanised Racking Load Tables

Table 22 gives an indication only of the safe load, uniformly distributed, in Kg, that may be carried per shelf consisting of front and back pipes when used as continuous beams.

For uneven load distributions or single spans, the required tube size must be determined by standard bending moment calculations assuming a **KEE KLAMP** joint to give a simply supported beam.

At loads greater than 900Kg consideration must be given to set screw slip.

Table 22: Beam load tables (Kg)

Span (m)	Fitting Size				
	5	6	7	8	9
	Tube Size				
	26.9mm x 2.6	33.7mm x 3.2	42.4mm x 3.2	48.3mm x 3.2	60.3mm x 3.6
0.5	540	1060	1750	2380	4000
0.6	435	850	1407	1870	3250
0.7	375	730	1207	1595	2760
0.8	330	645	1063	1385	2420
0.9	295	579	946	1230	2160
1.0	265	525	850	1110	1950
1.1	240	478	770	1013	1775
1.2	219	438	705	930	1625
1.3	202	403	651	858	1497
1.4	187	373	604	796	1387
1.5	175	347	564	741	1290
1.6	-	325	529	693	1205
1.7	-	306	499	650	1129
1.8	-	290	472	613	1061
1.9	-	277	448	581	999
2.0	-	268	427	553	987
2.1	-	-	408	528	944
2.2	-	-	391	505	855
2.3	-	-	376	485	818
2.4	-	-	362	467	785
2.5	-	-	349	450	755
2.6	-	-	-	434	728
2.7	-	-	-	419	703
2.8	-	-	-	405	680
2.9	-	-	-	-	659
3.0	-	-	-	-	639
3.1	-	-	-	-	620
3.2	-	-	-	-	603
3.3	-	-	-	-	588
3.4	-	-	-	-	575
3.5	-	-	-	-	564

Table reflects a safety factor of 1.67:1

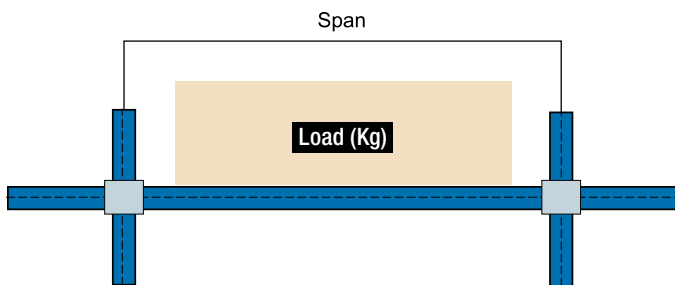

Table 23 gives an indication only of the safe load, in Kg, that may be carried between the above restraints by single tubes to BS EN 10255 (ISO 65) when used as uprights.

Table 23: Load table (Kg) – unfixed upright

Length (m)	Fitting Size				
	5	6	7	8	9
	Tube Size				
	26.9mm x 2.6	33.7mm x 3.2	42.4mm x 3.2	48.3mm x 3.2	60.3mm x 3.6
0.3	1720	2950	4038	4783	7044
0.4	1435	2617	3703	4446	6661
0.5	1150	2284	3368	4109	6278
0.6	910	1951	3033	3772	5895
0.7	725	1618	2690	3435	5512
0.8	590	1348	2363	3098	5129
0.9	480	1128	2028	2761	4746
1.0	-	948	1752	2424	4363
1.1	-	798	1524	2134	3980
1.2	-	-	1340	1884	3597
1.3	-	-	1188	1668	3253
1.4	-	-	1066	1484	2951
1.5	-	-	-	1328	2681
1.6	-	-	-	-	2441
1.7	-	-	-	-	2226
1.8	-	-	-	-	2032
1.9	-	-	-	-	1857
2.0	-	-	-	-	1697

Table reflects a safety factor of 2:1

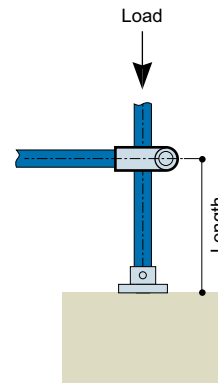

Table 24 (on page 49) gives an indication only of the safe load, in Kg, that may be carried between the above restraints by single tubes when used as uprights.

At loads greater than 900Kg* consideration must be given to set screw slip (*rating includes a safety factor of 2:1.74).

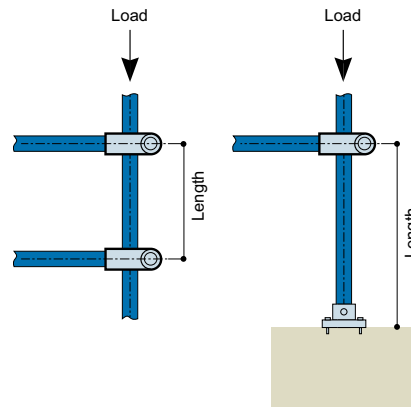

Table 24: Load tables (Kg) – fixed uprights

Length (m)	Fitting Size				
	5	6	7	8	9
	Fitting Size				
	26.9mm x 2.6	33.7mm x 3.2	42.4mm x 3.2	48.3mm x 3.2	60.3mm x 3.6
0.3	1860	3086	4192	4916	7250
0.4	1600	2810	3910	4638	6930
0.5	1360	2534	3628	4360	6610
0.6	1140	2258	3346	4082	6290
0.7	940	1982	3064	3804	5970
0.8	775	1706	2782	3526	5650
0.9	640	1471	2500	3384	5330
1.0	540	1269	2235	3248	5010
1.1	-	1092	1995	2970	4690
1.2	-	937	1779	2692	4370
1.3	-	-	1587	2414	4050
1.4	-	-	1417	2169	3730
1.5	-	-	1265	1954	3410
1.6	-	-	1130	1764	3130
1.7	-	-	-	1602	2890
1.8	-	-	-	1462	2680
1.9	-	-	-	1342	2480
2.0	-	-	-	1242	2300
2.1	-	-	-	-	2120
2.2	-	-	-	-	1950
2.3	-	-	-	-	1800
2.4	-	-	-	-	1650

Table reflects a safety factor of 2:1

Aluminium Racking Load Tables

Values shown have a safety factor of 2 built into them and are based on the limit state of the material used.

The values in Table 25 are an indication of a UDL that a rack consisting of two continuous support tubes can support.

For uneven load distributions, the required tube size must be determined by standard bending moment and deflection calculations assuming the **KEE LITE** joint to give a simply supported beam.

Table 25: Beam load table (Kg)

Span (m)	Fitting Size			
	6	7	8	9
	Tube Size (mm)			
	25 N.B.	32 N.B.	40 N.B.	50 N.B.
Grade of Material – 6082 T6 Aluminium				
0.3	1140	2468	4230	8693
0.6	285	617	1057	2173
0.9	126	274	470	965
1.1	84	183	314	646
1.2	71	154	264	543
1.5	45	98	169	347
1.7	35	76	131	270
2.1	23	50	86	177
2.3	-	42	71	147
2.4	-	38	66	135
2.7	-	-	52	107
3.0	-	-	42	86

At loads greater than 770Kg* consideration must be given to grubscrew slippage. (*A safety factor of 2 being applied in this instance.)

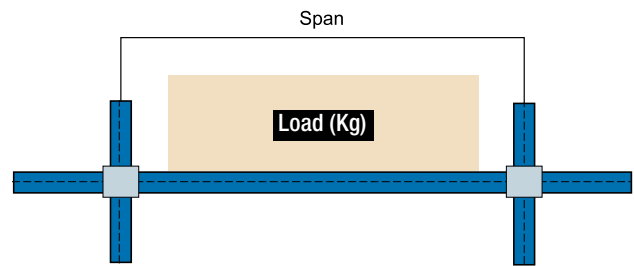

Values shown have a safety factor of 2 built into them and are based on the limit state of the material used.

Table 26 gives an indication only of the safe load, in Kg, that may be carried between the above restraints by single tubes when used as uprights.

Table 26: Load tables (Kg) – unfixed upright bases

Height (m)	Fitting Size			
	6	7	8	9
	Tube Size (mm)			
	25 N.B.	32 N.B.	40 N.B.	50 N.B.
Grade of Material – 6082 T6 Aluminium				
0.30	2431	4174	5249	7382
0.40	1653	3470	4593	6994
0.45	1296	2636	3675	6640
0.50	891	1977	3150	5934
0.60	502	1538	2441	5122
0.70	405	1274	1969	3850
0.75	324	725	1706	3355
0.80	267	593	1260	2755
0.90	251	505	1129	2402
1.00	210	461	997	2048
1.05	178	395	525	1942
1.10	-	351	499	1589
1.20	-	329	394	1448
1.30	-	308	381	1271
1.40	-	285	357	742
1.45	-	-	314	600
1.50	-	-	276	557
1.60	-	-	-	530
1.67	-	-	-	466
1.75	-	-	-	441
1.80	-	-	-	406
1.90	-	-	-	369
2.00	-	-	-	351

Table reflects a safety factor of 2:1

At loads greater than 770Kg consideration must be given to grubscrew slippage (a safety factor of 2 being included in this instance).

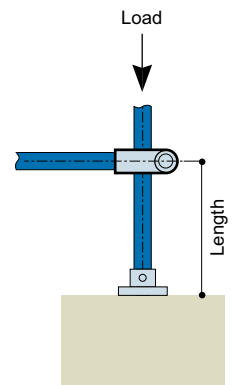

Values shown have a safety factor of 2 built into them and are based on the limit state of the material used.

Table 27 gives an indication only of the safe load, in Kg, that may be carried between the above restraints by single tubes when used as uprights.

At loads greater than 770Kg consideration must be given to grubscrew slippage (a safety factor of 2 being included in this instance).

Table 27: Load tables (Kg) – uprights restrained both ends

Height (m)	Fitting Size			
	6	7	8	9
	Tube Size (mm)			
	25 N.B.	32 N.B.	40 N.B.	50 N.B.
	Grade of Material – 6082 T6 Aluminium			
0.30	3549	5052	6063	8300
0.40	3371	4789	5906	8123
0.45	3160	4723	5722	8053
0.50	2625	4393	5512	7841
0.60	2399	4174	5249	7700
0.70	2009	3778	5118	7417
0.75	1750	3405	4803	7064
0.80	1378	2965	4147	6994
0.90	1215	2592	3622	6605
1.00	1102	2240	3360	6181
1.05	940	1933	3097	5828
1.10	843	1845	2703	5474
1.20	-	1538	2493	5122
1.30	-	1427	2231	4768
1.40	-	1318	1969	3956
1.45	-	1208	1785	3814
1.50	-	1076	1627	3461
1.60	-	988	1522	3108
1.67	-	-	1443	2755
1.75	-	-	1286	2543
1.80	-	-	1181	2402
1.90	-	-	-	2296
2.00	-	-	-	2155
2.05	-	-	-	2048
2.10	-	-	-	1801
2.20	-	-	-	1730
2.30	-	-	-	1589
2.40	-	-	-	1519

Table reflects a safety factor of 2:1

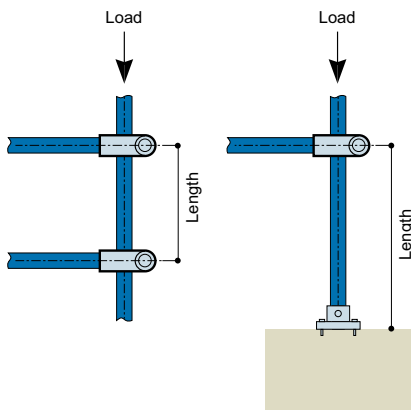

Vibration Test

Test Report:

Vibration of Kee Klamp® Assemblies

Exhaustive tests on samples of standard size 7 **KEE KLAMP** fittings were performed by an independent research laboratory. The purpose of the test was to evaluate the use of either standard set screws or self-locking set screws.

Test Arrangement

A “Tee” section test assembly was made using three 300mm lengths of galvanised size 7 standard tube held together by a three socket tee fitting (Type 25-7). The vertical leg of the test assembly was supported in a standard railing flange (Type 62-7). The completed assembly was then rigidly attached to the vibration table.

The test assembly was initially assembled using standard set screws and tested in this configuration. The standard set screws were then replaced with the self-locking screws and the tests repeated.

Test Procedure

The test was conducted on a Ling 667Kg Electromagnetic Vibration Table. The table was programmed to perform a resonance search between 25 and 350Hz and resonant frequencies were recorded and shown in Table 28.

Table 28: Test Results

Resonance Frequencies	Q Factor	Running Time
74	1.27	Nil
106	1.27	Nil
158	1.53	6 hours
200	1.8	6 hours
221	5	6 hours
295	9	6 hours

During the resonance search, amplification factors (Q) were measured at each resonant frequency, the point of reference being the end of one horizontal tube. The table was then held at one of the resonant frequencies, set in motion with a controlled acceleration level of 4g, and ran for a period of six hours. This was repeated for three more resonant frequencies in descending order of Q factor.

Furthermore, during the twenty-four hours of vibration at the four resonant frequencies above, no signs of loosening with either type of attachment screw occurred.

Comprehensive data showing the telescopic relationship between tubes to BS EN 10255 (ISO 65) is shown in Table 29 (page 51).

Table 29: The telescopic relationship between tubes to BS EN 10255 (ISO 65)

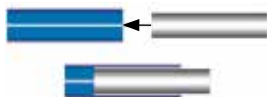

Size 9 heavy	Will accept 8 heavy or medium
Size 9 medium	Will accept 8 heavy or medium
Size 8	No telescopic relationship
	Requires special spigotting material
Size 7 heavy	Will only accept size 6 light
Size 7 medium	Will accept size 6 light, medium and heavy
Size 6 heavy	No telescopic relationship
	Requires special spigotting material
Size 6 medium	Will only accept size 5 light
Size 5 heavy	No telescopic relationship
	Requires special spigotting material
Size 5 medium	No telescopic relationship
	Requires special spigotting material
Size 4	No telescopic relationship
	Requires special spigotting material
Size 3	No telescopic relationship
	Requires special spigotting material





Kee Safety LLC
Dubai Investment Park
Near Green Community PO
Box 18448 Dubai
United Arab Emirates

Tel: +971 4 885 9066

Email: uaesales@keesafety.com
www.keesafety.ae