



SAFETY AT THE HIGHEST LEVEL

KeeLine II Instructions for Use Manual



Contents

SECTION	CONTENTS	PAGE	SECTION	CONTENTS	PAGE
1	INTRODUCTION	1	5.4	System Plaque	15
1.1	Validity	1	5.5	Extremity Assemblies	15
1.2	Authorised Agent	1	5.6	Intermediate Assemblies	16
1.3	Compatibility	1	5.7	Corner Assembly	16
1.4	Health & Safety	1	5.8	Wire Installation	17
1.5	Familiarisation	1	5.9	Postanka Mounted Systems	18
1.6	Certifying Body	1	5.10	Wall & Steelwork Mounted Systems	18
1.7	Anticipated Life	1	5.11	Single Point Anchor Assembly	20
1.8	Safeguarding the Instruction For Use Manual	1	5.12	Installation of the KeeLine Overhead System	20
1.9	Copyright	1	6	GENERAL GUIDANCE FOR USING KEELINE	21
1.10	Amendment Service	1	6.1	General	21
1.11	Modifications to the KeeLine System	1	6.2	Exclusion Zone	21
1.12	Definition of Authorised Person	1	6.3	Number of Users	21
1.13	Definition of Trained Person	1	6.4	Pre-use Checks	21
1.14	Use in Accordance with Regulations	2	6.5	Attaching the Traveller	22
1.15	Incorrect Use	2	6.6	System Plaques	23
1.16	Operators Duty of Care	2	7	EXAMINATION, MAINTENANCE & STORAGE	23
1.17	Medical Condition of Users	2	7.1	Instructions for Periodic Examination	23
1.18	Personnel Requirements	2	7.2	Swageless Wire Termination	23
1.19	Rescue	3	7.3	Maintenance & Storage	23
1.20	Atmospheric Conditions	3	8	INSTRUCTIONS FOR REPAIR / REPLACEMENT	24
1.21	Contaminated Surfaces	3	9	RECORDS	24
2	BASIC SAFETY INSTRUCTIONS	3	10	GENERAL WARNINGS	24
3	COMPONENT PARTS	4	10.1	Alterations	24
4	LAYOUT	10	10.2	Unintended Use	24
4.1	Restraint Systems	10	10.3	Safety of Combined Components	24
4.2	Fall Arrest Systems	10	10.4	Minimise Any Free Fall Potential	24
4.3	Minimum Height of KeeLine® Overhead System	10	10.5	Free Space Beneath the User	24
4.4	Minimum clear free fall distance	11	10.6	Personal Issue Equipment	24
5	INSTALLATION	12	10.7	Hazards	24
5.1	Tool List	12	11	TRANSPORTATION	25
5.2	Baseplates	12	12	MARKINGS ON THE PRODUCTS AND THEIR MEANING	25
5.3	Posts	15			

1. INTRODUCTION

1.1 Validity

These operating instructions apply to the following product:

Type: KeeLine® II Anchor System
Model Year: 2016

1.2 Authorised Agent

Kee Safety Limited
Cradley Business Park
Overend Road
Cradley Heath
B64 7DW

Tel: +44 (0) 1384 632188
E-Mail: sales@keesafety.com
Internet: www.keesafety.co.uk

1.3 Compatibility

KeeLine® II is designed to provide continuous protection against falls in almost any situation where there is a need to work at height, where collective protection measures are not available.

KeeLine® II is tested to the requirements of EN795:2012 Type C and CEN TS 16415.

The KeeLine® II system can be used with PPE according to;

- EN 354 (Lanyards)
- EN 355 (Energy absorbers)
- EN 360 (Retractable type fall arresters) (> prEN 360:2016)
- EN 361 (Full body harnesses)
- EN 353-2 (Guided type fall arresters including a flexible anchor line)
- EN 358 (Belts for work positioning and restraint and work positioning lanyards)

 As there is the possibility of the system having to arrest a fall, means of dissipating energy (e.g. a device or system to EN355) should be incorporated to keep the maximum impact force to below 6kN.

- A full body harness to EN361 is the only acceptable form of body holding device for fall arrest systems.
- The KeeLine Overhead system has been tested for use with the Xcaliber FABX1, EN 360 compliant self-retracting lifeline. Kee Safety does not recommend the use of any other make without prior conformance testing and written approval.

1.4 Health and Safety

Installers and users must comply with all relevant health and safety regulations in their given territory.

1.5 Familiarisation

 Before using KeeLine® II for the first time, the installers are required to attend a Kee Safety Installation Course

ADVICE

1.6 Certifying Body

Zertifizierungsstelle
DEKRA EXAM GmbH
Dinnendahlstraße 9
44787 Bochum
Germany

1.7 Anticipated Life

Metal Components: Up to 25 years in non-marine, non-corrosive (e.g. chemical plant) environments with a temperature range from -10 to + 40 degrees centigrade subject to use and a mandatory annual inspection strictly in accordance with these instructions.

1.8 Safeguarding the Instruction Manual

This Instructions for Use document forms a component part of the KeeLine® II system. It must accompany the system and be followed for assembly. At no time must any pages be removed from these instructions. If the instructions are lost in their entirety or in part, the instructions or the missing parts must be replaced immediately.

1.9 Copyright

This documentation contains information protected by copyright. It may not be photocopied, reproduced, translated or recorded on data media, either completely or as extracts, without prior permission. We reserve all further rights.

1.10 Amendment Service

This document is not subject to any amendment service from the manufacturer. Amendments to this documentation can be carried out without prior notice.

1.11 Modifications to The KeeLine® II system

If you undertake modifications to the KeeLine® II system, you will negate all certification that comes with this product.

1.12 Definition “Authorised Person”

A person is deemed to be an authorised person if they have been authorised to work on or with the KeeLine® II system in accordance with these instructions.

1.13 Definition “Trained Person”

Trained persons, are persons who, based on their specialist training and experience have adequate knowledge of the system to be checked and are sufficiently familiar with the relevant regulations, guidelines and generally recognised rules of the KeeLine® II system and accompanying regulations - e.g., Health and Safety Regulations and Accident Prevention Regulations that are in force in the country of use; and can assess the safe working conditions of the installation location. A trained person shall be responsible for selecting all users of The KeeLine® II system.

1.14 Use in Accordance with Regulations

The KeeLine® II system is a Horizontal Flexible Anchor Line system. It is a component part of a personal protection system for the prevention of falls from heights and may be used only in conjunction with the relevant personal protective equipment.

The user must follow the recommendations provided within this Instructions for Use Manual. The KeeLine® II system is deemed to be used in accordance with regulations only when all the following conditions are met:

- The combination of the KeeLine® II position and the PPE supplied ensures that no user is able to reach the roof edge, roof opening or other fall hazard when used as a RESTRAINT SYSTEM.
- All users must be equipped with a means of ensuring that the forces applied to the body (and therefore to the anchor device) during the arrest of a fall does not exceed 6kN.
- The potential danger that arises when The KeeLine® II system is used in conjunction with fall arrest equipment to EN360, or energy absorbing devices (to EN355) must be assessed.
- The KeeLine® II system is designed only for use on roofs of the types shown at section 3.3.2
- The KeeLine® Overhead system is designed only for suitable load bearing structures
- Do not use if there is the risk of frost or in freezing conditions.
- Do not position The KeeLine® II system where there is a risk of accumulation of water or where there is contamination of the roof surface and / or any KeeLine® II component by oil, grease or growth of algae.
- Use of KeeLine® II in high winds is not permitted.
- Ensure that all fragile roof lights in the work area are covered to prevent falls through them. Only use The KeeLine® system when all conditions are met! Your life depends on it

1.15 Incorrect Use

The following conditions are classified as incorrect use:

- The use of the KeeLine® II system when one of the conditions listed under “use in accordance with regulations” is not met.
- The failure to observe the minimum edge and free fall distances and conditions imposed on the supporting base listed in “use in accordance with regulations.”
- The use of a damaged, incomplete or incorrectly assembled KeeLine® II system.
- Use as an anchor for access by rope or for abseiling. A purpose designed deadweight anchor system Accessanka is available for this purpose.
- Use by an operative without prior instruction by a competent, trained person.
- Working in the vicinity of fragile roof lights without covering them to prevent falls through them. A purpose made freestanding guardrail solution “Kee Dome” is available for this purpose.

Use of The KeeLine® II system in any of the above conditions is forbidden

1.16 Operator's Duty of Care

The duties and obligations of the operator and trained personnel when dealing with The KeeLine® II system are set out below.

a) Safety of The KeeLine® II system

The operator or trained personnel must ensure that The KeeLine® II system:

- is used only in accordance with Health and Safety regulations.
- is made available for use only in a proper, functional state.
- is used in accordance with the regulations set out herein.
- is checked regularly.
- is used only by qualified, trained and authorised personnel.

b) Protection of Personnel

All persons using the system must ensure that the necessary personal protective equipment:

- is available for use and IS USED (See 1.3 Compatibility).
- is checked regularly and the check recorded.

c) Instruction and Training

All users of the system must ensure that:

- before using the system for the first time and at least once annually thereafter, all personnel shall be instructed in all relevant matters of health and safety at work (with particular emphasis on Working at Height) and environmental protection.
- the operating instructions are always available in a legible state, are complete and are kept with the system at all times.
- all users are familiar with the contents of these operating instructions.

1.17 Medical Condition of Users

Users of KeeLine® II as part of a fall protection system should be physically capable and free from any impairment that could prevent them from working safely.

1.18 Personnel Requirements

DANGER TO LIFE!



Users of KeeLine® II should be trained and competent in its safe use and in the use of all attached components. If any of the information or marking is not fully understood, or if it is considered that more information is required in order to work safely, users are strongly recommended to contact the supplier or manufacturer before using this equipment in the workplace.

The requirements the manufacturer places on the users of The KeeLine® II system are as follows:

Introduction

a) Duties of the User

The user must fulfil the following duties:

- Assemble The KeeLine® II system strictly in accordance with this Instructions for Use Manual and check that the system is functioning correctly and safely.
- Recognise any defects and withdraw the system from use and alert the manufacturer so an assessment and required repairs can be completed.

b) Requirements of the User

In order to be able to fulfil his or her duties, the user must meet the following requirements:

- The user must be Competent in the selection and use of the PPE combination used in conjunction with the KeeLine® II system)
- They must have adequate knowledge of the English language to understand these operating instructions.
- They must be free from any disability that may affect their ability to use this system or understand these instructions.
- It is unlikely that any medical condition may directly affect (or be affected by) the use of this product in itself, but users must be aware that:
 - Working at height is a dangerous occupation. They should be trained to do so, and should comply with any medical requirements set by the training provider.
 - The manufacturer or supplier of PPE to be used with this product may impose medical requirements on users of their products, which must be complied with.

1.19 Rescue

DANGER TO LIFE!



Before working at a height commences and at regular intervals thereafter for the duration of the job, a risk assessment should be made. This assessment should include all possible emergency scenarios and a plan should be in place as to how any resulting rescues would be carried out quickly and efficiently.

Remember that the survival of an injured person often depends on the speed of rescue and the care given to the casualty during and after the rescue.

1.20 Atmospheric Conditions



DANGER TO LIFE!

This anchor device should never be used during periods when there is frost, ice or snow on the roof, or if these conditions are imminent. Frost, ice and snow means NO. It is also advisable not to work on roofs during strong winds.

1.21 Contaminated Surfaces



DANGER TO LIFE!

Do not use KeeLine® II if oil, grease or other lubricant, or growth of algae contaminates the roof surface or any part of the system.

For Your Safety

2 BASIC SAFETY INSTRUCTIONS

Basic safety instructions for the safe handling of the KeeLine® II system can be found here.

DANGER TO LIFE!



It is imperative that you follow these safety instructions to avoid endangering your life and safety.

Possible Danger	Measures for Avoidance
<p>DANGER TO LIFE! Risk of fatalities / injuries as a result of incorrect system assembly. Explanation: Falls resulting in death or severe injuries can result from the defective assembly of the KeeLine® II system.</p>	<p>Assemble the KeeLine® II system only as described in this Assembly & operating Manual. After assembly and before use, check all components and connector parts for correct assembly & positioning. Damaged parts shall not be used for assembly.</p>
<p>DANGER TO LIFE! Risk of fatalities / injuries as the result of poor layout design / positioning. Explanation: Falls resulting in death or severe injuries can result from installing the KeeLine® II system in areas which increase the risk of falling, or falling in an area with insufficient free fall distance to arrest a fall.</p>	<p>Do not install over roof lights / sky lights, or any roof opening, exit or too close to a roof edge. Ensure that there is adequate free fall distance should a user fall. For example, pay particular attention to lower roofs, roof canopies, flag poles, loading bays, vehicular and pedestrian traffic below. Ensure free fall distance is adequate by consulting the KeeLine® II Calculator.</p>
<p>DANGER TO LIFE! Risk of fatalities / injuries as the result of installing the KeeLine® II system into / onto weak structure.</p>	<p>Always ensure the structure to which the Kee Line® II system is to be installed into / onto has sufficient strength to ensure the structure does not fail during normal use of the KeeLine® II system, or when the system arrests a fall. When in doubt, guidance from an experienced structural engineer and/or Kee Safety should be sought.</p>
<p>DANGER TO LIFE! Risk of fatalities / injuries as a result of defective or inadequate maintenance. Explanation: Defects or damage relevant to safety can adversely affect the functionality of the KeeLine® II system. In these circumstances, the safe functioning of the system is not assured.</p>	<p>Before use, check KeeLine® II for damage. Damaged parts must be replaced before use in all cases. Only after this may the KeeLine® II system be used! In the case of doubt, change the equipment. In the case of a user falling on KeeLine® II change the equipment</p>
<p>DANGER TO LIFE! Risk of fatalities / injuries due to KeeLine® II system being installed onto a roof which is too steep! Explanation: KeeLine® II is designed for use on nominally flat (max. 15° pitch) roofs and must only be used on pitched roofs where the expected direction of any fall is perpendicular to the direction of the horizontal line system.</p>	<p>Always ensure the KeeLine® II system does not deviate from the horizontal by more than 15°.</p>

KeeLine Components

3 COMPONENT PARTS

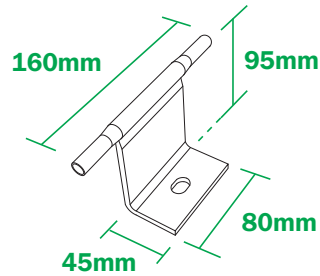
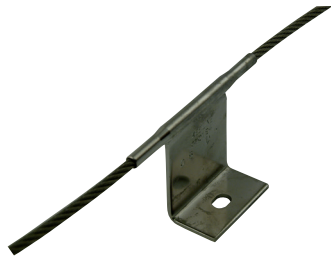

STANDARD INTERMEDIATE BRACKET - Wall and Roof Mounted INTW010

Designed to allow the Traveller to pass over the brackets without detaching from the system. Maximum span of 15m between Intermediate Brackets. Material : Stainless steel AISI 316L. Breaking strength >12kN. Net weight : 0.49kg.

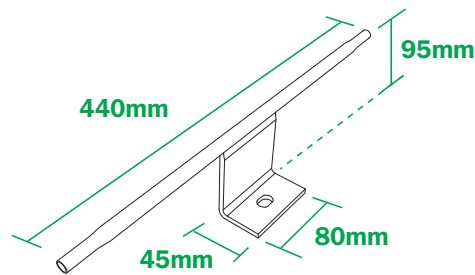

EXTENDED INTERMEDIATE BRACKET - Wall and Roof Mounted INTEW010

Designed to allow the Traveller to pass over the brackets without detaching from the system. Maximum span of 15m between Intermediate Brackets. Material : Stainless steel AISI 316L. Breaking strength >12kN. Net weight : 0.63kg.

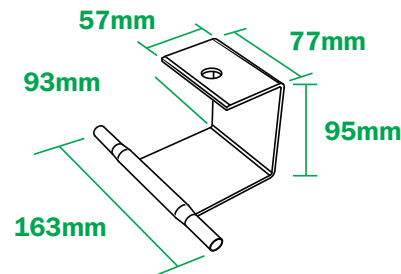

STANDARD INTERMEDIATE BRACKET - Overhead - KOINT

Designed to allow the Traveller to pass over the brackets without detaching from the system. Maximum span of 15m between Intermediate Brackets. Material : Stainless steel AISI 316L. Breaking strength >12kN. Net weight : 0.8kg.

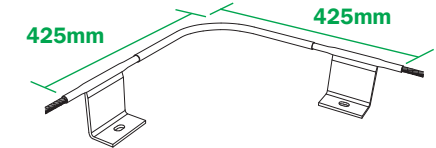

CORNER TUBE - Wall mounted 90° - CNR-90-W Wall mounted 135° - CNR-135-W

Allows the system to turn through 90° or 135° Other angles can be achieved via cutting the tube in order to form the required angle. Material : Stainless steel AISI 316L. Ø 13.5mm. Net weight : 0.2kg. (Tube only) Net Weight : 1.03kg. (Complete assembly)

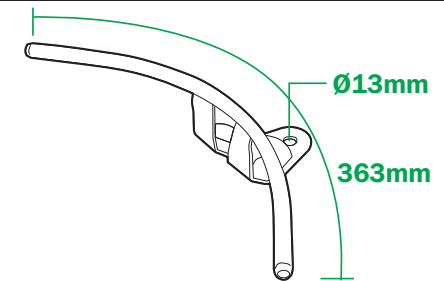

CORNER BRACKET - Wall and Roof mounted 90° - LAKL20090

Allows the system to turn through 90° or 135° Other angles can be achieved via cutting the tube in order to form the required angle. Material : Stainless steel AISI 316L. Ø 13.5mm. Net weight : 0.46kg.

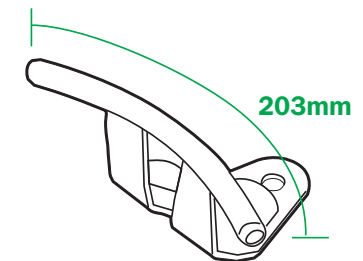

CORNER BRACKET - Wall and Roof mounted 45° - LAKL20045

Allows the system to turn through 90° or 135° Other angles can be achieved via cutting the tube in order to form the required angle. Material : Stainless steel AISI 316L. Ø 13.5mm. Net weight : 0.388kg.



KeeLine Components

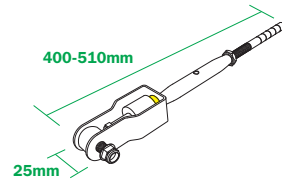

OVERHEAD TENSIONER AND TENSION INDICATOR - KOTEN

The pretension indicator is a way of instantly adjusting and checking the correct tension of the life line cable. The Tension Indicator (yellow) is set to 3kN when used on an overhead system. Material : Stainless steel AISI 316L. Breaking strength >22kN. Net weight : 1kg.

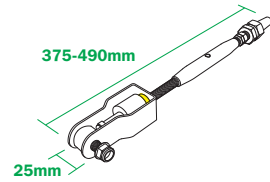

OVERHEAD SWAGELESS TENSIONER AND TENSION INDICATOR - KOTENS

The pretension indicator is a way of instantly adjusting and checking the correct tension of the life line cable. The Swageless Tension Indicator (yellow) is set to 3kN when used as an overhead system. Material : Stainless steel AISI 316L. Breaking strength >22kN. Net weight : 1.3kg.

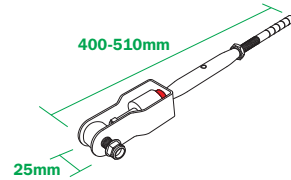

STANDARD TENSIONER AND TENSION INDICATOR - TENS10

The pretension indicator is a way of instantly adjusting and checking the correct tension of the life line cable. The Tension Indicator (red) is set to 1kN for horizontal systems. Material : Stainless steel AISI 316L. Breaking strength >22kN. Net weight : 1.07kg.

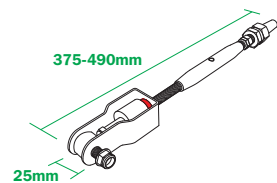

STANDARD SWAGELESS TENSIONER AND TENSION INDICATOR - LA-SWTEN

The pretension indicator is a way of instantly adjusting and checking the correct tension of the life line cable. The Swageless Tension Indicator (red) is set to 1kN for horizontal systems. Material : Stainless steel AISI 316L. Breaking strength >22kN. Net weight : 1.21kg.

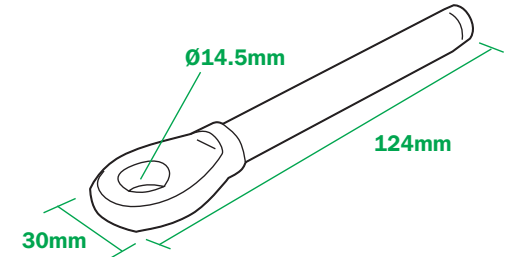

SWAGE END FITTING - LAKL2HEX8

A swage connection ensures secure assembly of the Cable (diam 8mm) to the End Anchor. Material : Stainless steel AISI 316L. Breaking strength >22kN. Net weight : 0.13kg.

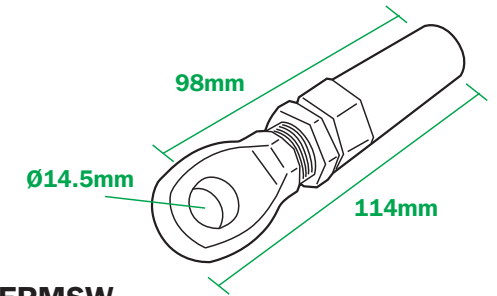

SWAGELESS END FITTING - LA-TERMSW

A swageless connection ensures secure assembly of the Cable (diam 8mm) to the End Anchor. Material : Stainless steel AISI 316L. Breaking strength >22kN. Net weight : 0.26kg.

	RESTRAINT SYSTEM SEPARATING PEOPLE FROM HAZARDS
HEAD OFFICE Kee Safety Limited Cradley Business Park Overend Road Cradley Heath West Midlands B64 7DW	SYSTEM NUMBER <input type="text"/>
(t) +44 (0) 1384 632 188 (f) +44 (0) 1384 632 192 (e) info@keesafety.co.uk (w) www.keesafety.co.uk	INSTALLATION DATE <input type="text"/>
	MAX NUMBER OF USERS <input type="text"/>
	LANYARD LENGTH NOT TO EXCEED <input type="text"/>
	ANNUAL INSPECTION RECOMMENDED <input type="text"/>
	● RE-TEST ONLY TO BE CARRIED OUT BY AUTHORISED SERVICE AGENT.

	FALL ARREST SYSTEM SEPARATING PEOPLE FROM HAZARDS
HEAD OFFICE Kee Safety Limited Cradley Business Park Overend Road Cradley Heath West Midlands B64 7DW	SYSTEM NUMBER <input type="text"/>
(t) +44 (0) 1384 632 188 (f) +44 (0) 1384 632 192 (e) info@keesafety.co.uk (w) www.keesafety.co.uk	INSTALLATION DATE <input type="text"/>
	MAX NUMBER OF USERS <input type="text"/>
	LANYARD LENGTH NOT TO EXCEED <input type="text"/>
	ANNUAL INSPECTION RECOMMENDED <input type="text"/>
	● RE-TEST ONLY TO BE CARRIED OUT BY AUTHORISED SERVICE AGENT.

SYSTEM PLAQUE - SL111/1

Provides details of the system and approvals. Material : plastic. Component weight : 0.085kg.

KeeLine Components

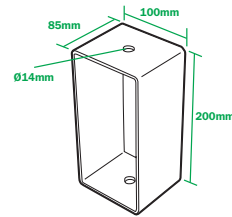

END DEFORMATION SUPPORT POST - STEX10

This post provides a standard method of connecting the system directly to the Base Plate.
Material : Galvanised steel to BS EN ISO 1461. Net weight : 1.8Kg.

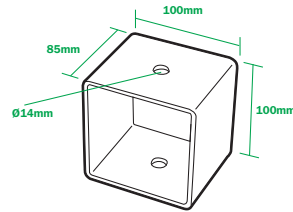

INTERMEDIATE AND CORNER DEFORMATION SUPPORT POST - LASTIC012

This post provides a standard method of connecting the system directly to the Base Plate.
Material : Galvanised steel to BS EN ISO 1461. Net weight : 0.974kg.

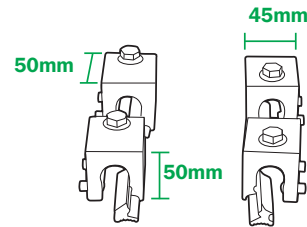
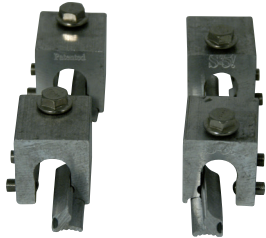

STANDING SEAM CLAMPS - Z5

These are used in conjunction with the Base Plate Metal Roofs – SPS10 to connect the plate to the roof structure. Material : Aluminium and stainless steel. Net weight : 1.04kg.

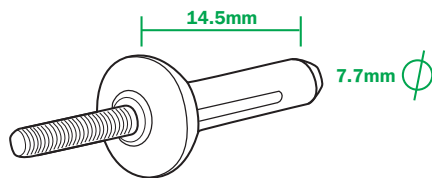

RIVETS (PKT100) - RIVETS

These are used in conjunction with the Base Plate Metal Roofs – SPS10 to connect the plate to the roof structure. Material : Aluminium. Net weight : 1kg per 100.

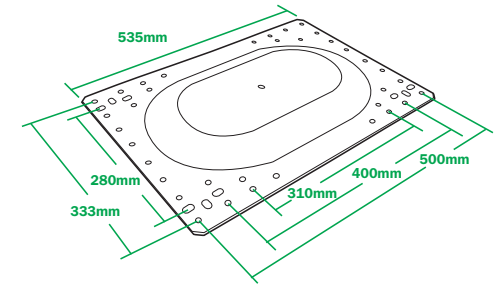
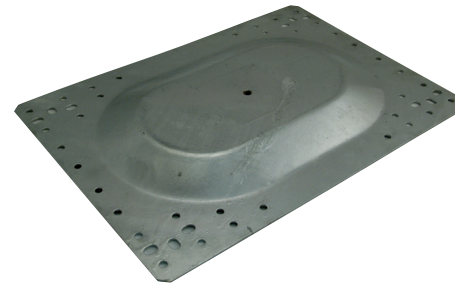

BASE PLATE METAL ROOFS - SPS10

This plate provides a method of connecting the system to a metal roof structure. Metal roof panels with minimum steel thickness 0.7mm require 3 Rivets per corner. Includes Butyl Sealing Strip to maintain roof's integrity (TA-SEAL 15m roll) Fixing centres: 500, 400, 333, 310. Composite roof panels with minimum steel thickness 0.5mm thick require 4 Rivets per corner. Includes Butyl Sealing Strip to maintain the roof's integrity (TA-SEAL 15m roll) Fixing centres: 333 mm

Standing seam roofs

Designed to clamp on to the standing seam of a proprietary roofing sheet.

Fixed with non penetrative Z5 clamps

Fixing centres: 305, 400, 500mm

Z5 (4 per pkt) Material : Galvanised steel to BS EN ISO 1461. Net weight : 5.75kg.

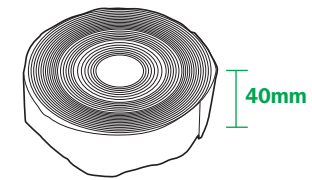

SEALING STRIP (15M ROLL) - TA-SEAL

This is used in conjunction with the Base Plate Metal Roofs – SPS10 to form a seal between the underside of the plate and the metal decking. Material : Butyl. Net weight : 4kg.

FIXINGS (TYPE AND QUANTITY AVAILABLE ON REQUEST)

- 1- M12 x 20 stainless steel hex head set screw
 - 1- M12 x 40 stainless steel hex head set screw
 - 2- M12 x 35 stainless steel flat washer
 - 2- M12 stainless steel spring washer
 - 2- M12 stainless steel flat washer
 - 2- M12 stainless steel nyloc nut
- Net weight : 0.15kg.

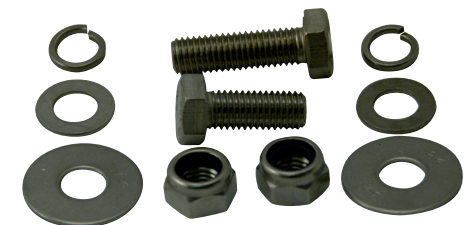



TRAVELLER - KL2TRAV

Designed to enable the user to move easily and safely along the Life Line. When mounted at roof level the user can move either side of the cable. A spring loaded pin fastens the Traveller on to the Cable. The connector is attached to the Traveller, thus locking the Traveller onto the Cable. The Traveller can be connected and disconnected at any point along the system.
Material : Z8CND17 04 Stainless steel. Breaking strength 12kN. Net weight : 0.3kg.

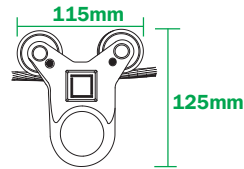

OVERHEAD WHEELED TRAVELLER - KOTRAV

Designed to enable the user to move easily and safely along the Life Line. The Traveller is permanently fitted to the overhead system cable. It is manufactured with brass bushes, thus no bearings to wear.
Material : Z8CND17 04 Stainless steel. Breaking strength 12kN. Net weight : 0.68kg.

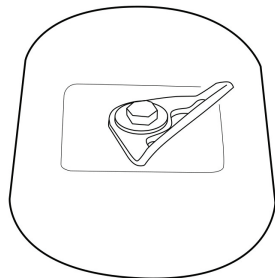
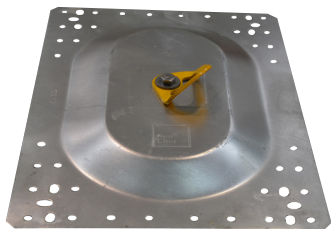

SINGLE POINT ANCHOR ASSEMBLY KIT - LAKL2SPAP

This provides a single anchor point when used in conjunction with any of the Support Posts. The design permits complete 360° rotation.
The kit comes complete with Bolt, Bush, Sealing Washer, Label and Screw Plastic Cover. (Baseplate sold separately).
Material : Stainless Steel.
Net weight : 0.176kg



CABLE - ROPE8SS7x7

Stainless steel AISI 316L 8mm diameter 7x7 structure with breaking strength > 37kN, is suitable for spans of up to 15m horizontal & overhead up to 24m between Intermediate Brackets. Net weight : 0.28kg. per metre.

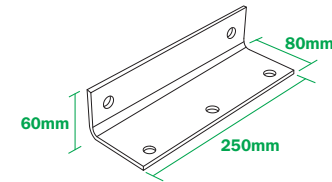

EXTREMITY FIXING BRACKET - LINE-XBRKT

The fixing bracket is designed to terminate the Life Line System at either end and is intended to provide direct attachment for Tensioners, Absorbers and pretension indicators. Alternative end components may be used, depending on the type of assembly.
Material : Stainless steel AISI 316L. Breaking strength >22kN. Net weight : 1.24kg.

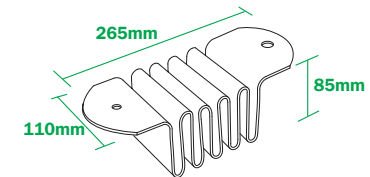

ENERGY ABSORBER - LASORB10

The Energy Absorber is designed to dissipate the energy generated throughout the system and reduce the end loadings to below 10kN. Installations require an absorber to be installed at both ends of the system. The element is a disposable device which must be replaced after each fall.
Material : Galvanised steel BS EN ISO 1461. Breaking strength >22kN. Activating force minimum 2.9kN. Net weight : 3.6kg.

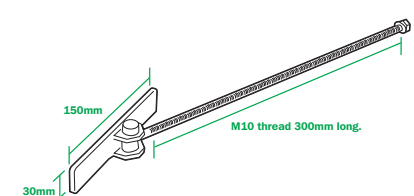
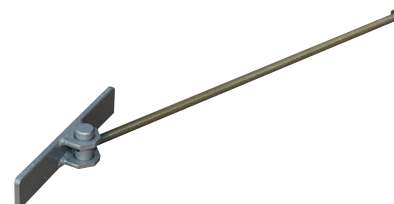

TOGGLE ASSEMBLY KIT (4No) - LAKL2TOG2

These are used in conjunction with the Flat Roof Post – LAKL2POST to connect the post to the roof structure. Length Standard 300mm Ø M8. Material : Steel Grade 8.8. Net weight : 0.258kg no thread.

KeeLine Components

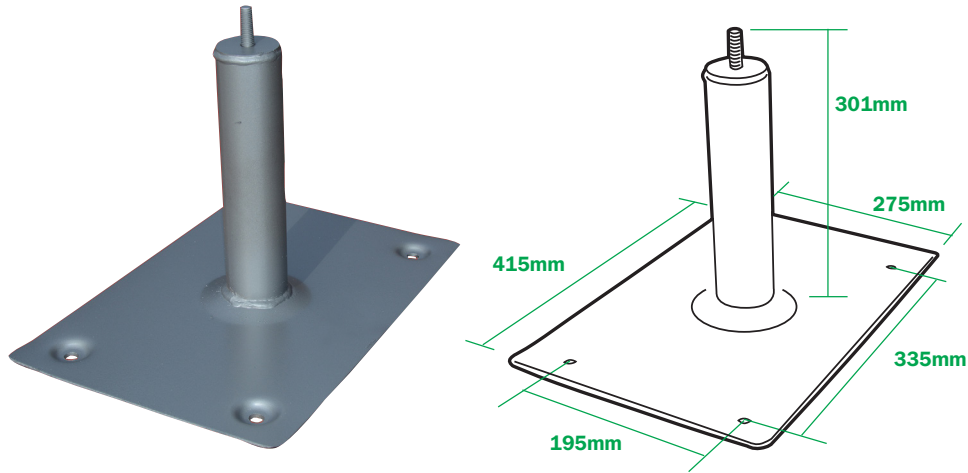

STANDARD FLAT ROOF POST- LAKL2POST

This post provides a standard method of connecting the system directly to the flat roof structure. The Flat Roof Post can be installed on top of the insulation and waterproof membrane via a toggle or chemical fixing. Cowling for weather detail selected separately.
Material : Stainless Steel AISI. Net weight Post : 4.168kg.

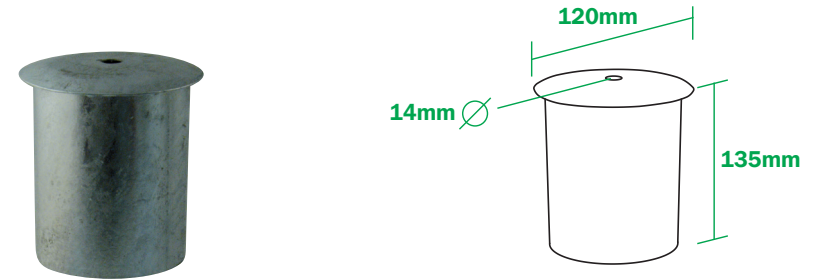
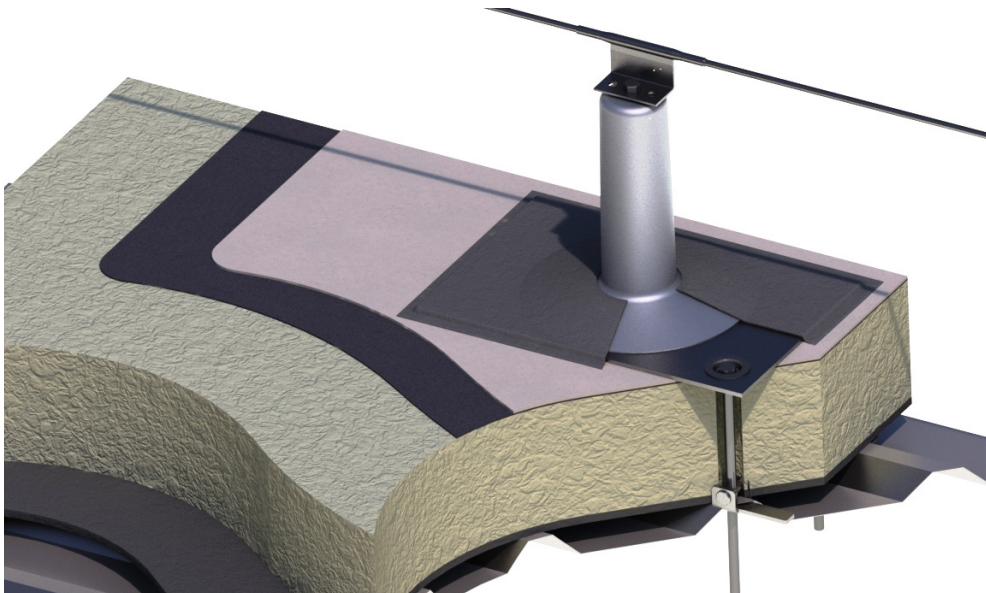

STANDARD WEATHER COWLING - COATED - WC120

This Cowling provides the weatherproofing detail.
Material : Galvanised steel to BS EN ISO 1461. Net weight Cowling : 1kg.

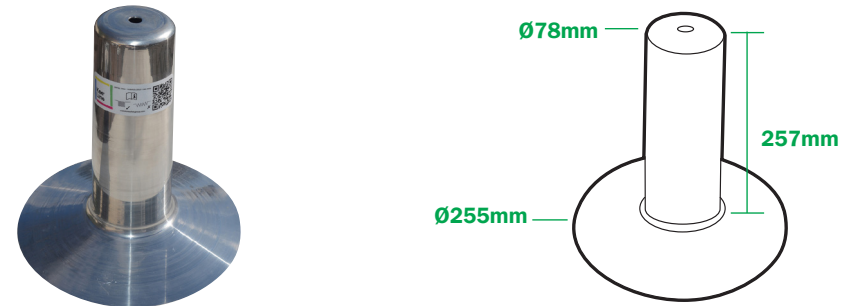

WEATHER COWLING - NON-COATED - LAKL20ALU

This Cowling provides the weatherproofing detail supplied non-coated
Material : Aluminium. Net weight : 0.396kg.

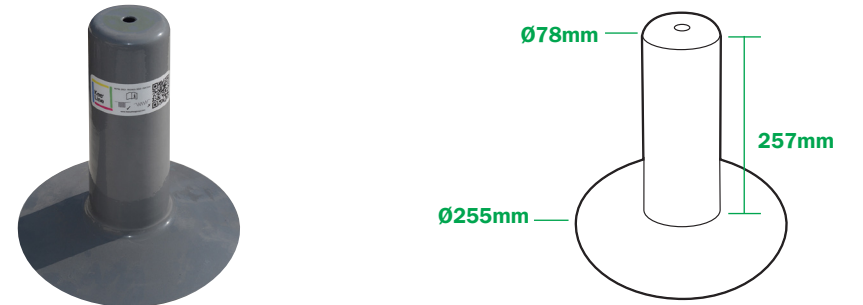

WEATHER COWLING - COATED - LAKL20PVC

This Cowling provides the weatherproofing detail supplied pre-coated for torchon single ply membranes
Material : Aluminium. Net weight : 0.494kg.

KeeLine Components

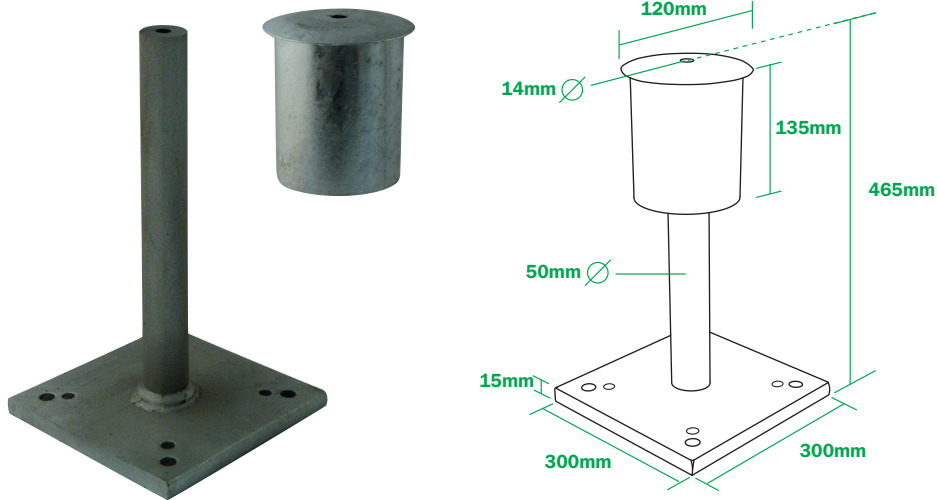

UNIVERSAL POSTANKA - TYPE 6 - T6SS450

This post provides a standard method of connecting the system directly to the structure. Cowling for weather detail supplied separately. Additional components (wings) can be provided for bespoke installations.

Material : Galvanised steel to BS EN ISO 1461. Net weight Post : 17.8kg. Cowling : 1kg.

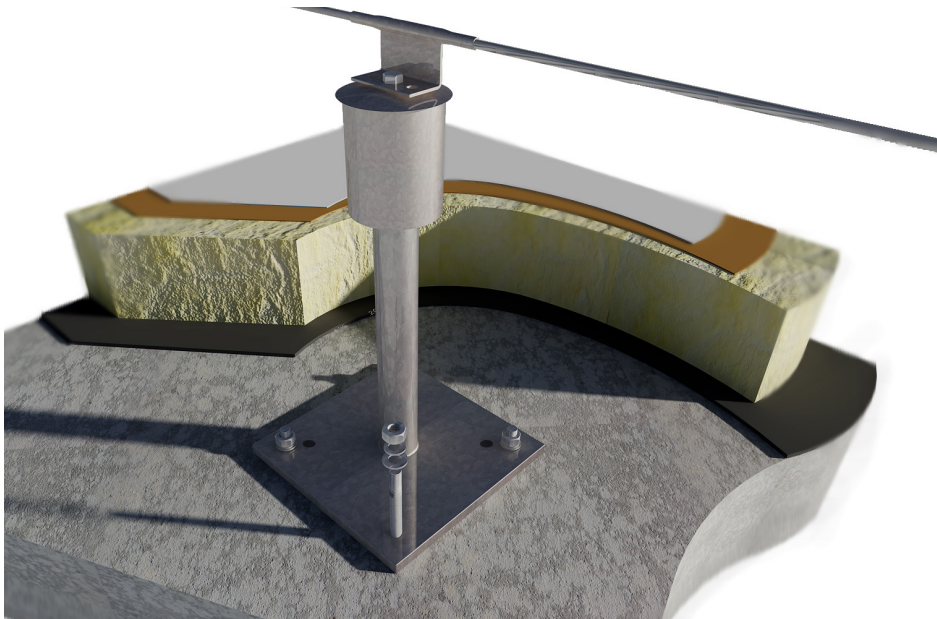
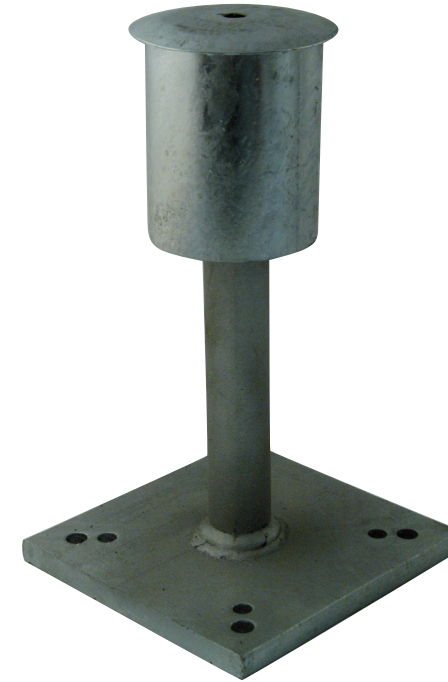

System Layout Planning, Assembly & Installation

4 LAYOUT

4.1 Restraint Systems

DANGER TO LIFE!

For systems to be classified as restraint, the combination of lanyard and full body harness **MUST PREVENT** any user from approaching the roof edge or other roof opening.

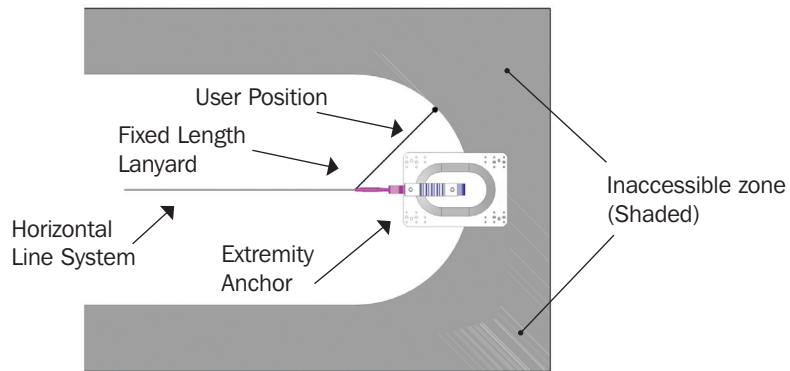

Skylights or other 'Fragile' roof openings

Always ensure that KeeLine® II system is installed away from skylights or other fragile roof panels / components. Where this is not possible, all fragile roof panels / components within the vicinity of the KeeLine® II system shall be covered.

4.2 Fall Arrest Systems – System Layout

At each end of the system the worker may be positioned anywhere in a semi-circle around the end post.

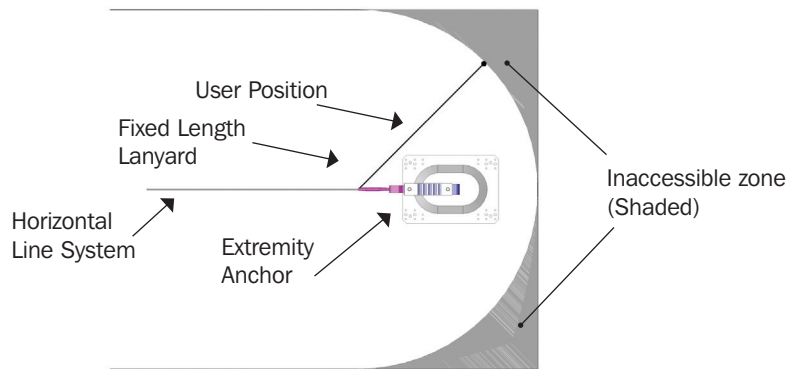

Skylights or other 'Fragile' roof openings

Always ensure that KeeLine® II system is installed away from skylights or other fragile roof panels / components. Where this is not possible, all fragile roof panels / components within the vicinity of the KeeLine® II system shall be covered.

4.3 Minimum Height of KeeLine® Overhead System Above Users Working Platform

Based on a maximum user height of 1.94m the systems extremity brackets are required to be a minimum height above users working platform of 2.5m (See figure 1) For users taller than this the KeeLine® Overhead will need to be positioned proportionately higher.

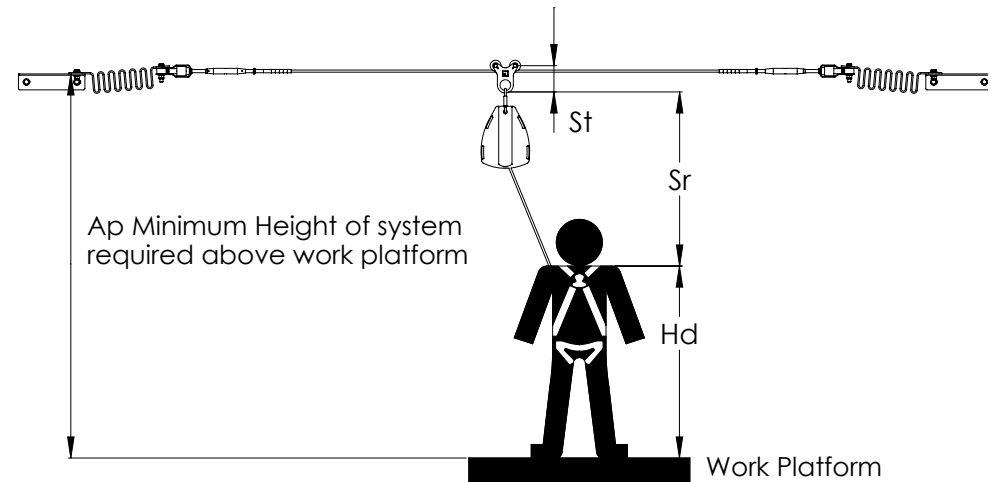

		Metres	Feets
St	Wire sag & traveller dim*	0.35	1' 1"
Sr	Over all height of SRL example	0.65	2' 1"
Hd	Height D-ring above platform when worker is standing	1.5	5'
Ap	>St+Sr+Hd	2.5	8' 2"

* Up to two SRL blocks weighing up to 5kg (11lb) each, for blocks heavier than this consult Kee safety

Figure 1 - Example of minimum height of KeeLine Overhead system above users' platform.

System Layout Planning, Assembly & Installation

4.4 Minimum Clear Free Fall Distance Required Below Users Working Platform

- The minimum free fall distances assume an EN360 clutch mechanism self-retracting lifeline (fall arrest block) that will limit the maximum arrest force (MAF) to no more than 4KN. For a MAF in excess of 4KN please contact Kee Safety as required free fall distance and end loads will be increased.
- For two users it is assumed that they would only fall simultaneously if working together in the same span.
- Minimum clear free fall distance required below users working platform The following formula shall be used to calculate the required minimum clearance below the platform: $C_p = FFD + MDD + x_s + (H_f - H_i) + E$ (Refer to Legend in Figure 2).

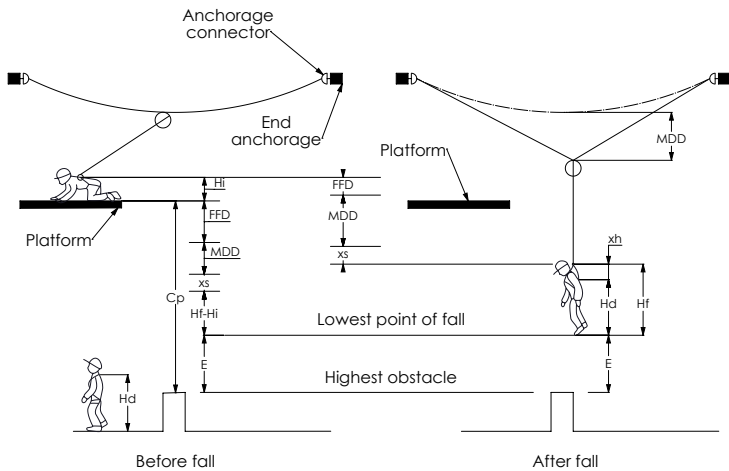

Figure 2 - Calculating minimum clearance distance below the work platform when using a lanyard or SRL

MDD Distances

Span Mtrs.	No of users	No. Of Spans										End Load
		1	2	3	4	5	6	7	8	9	10	
18-24m	2	3.76	3.91	4.06	4.21	4.36	4.51	4.66	4.81	4.96	5.11	13.05 Kn
18-24m	1	2.90	3.05	3.20	3.35	3.50	3.65	3.80	3.95	4.10	4.25	8.87 Kn
12-18m	2	3.04	3.14	3.24	3.34	3.44	3.54	3.64	3.74	3.84	3.94	11.50 Kn
12-18m	1	2.49	2.59	2.69	2.79	2.89	2.99	3.09	3.19	3.29	3.39	7.88 Kn
6-12m	2	2.48	2.53	2.58	2.63	2.68	2.73	2.78	2.83	2.88	2.93	9.62 Kn
6-12m	1	2.02	2.07	2.12	2.17	2.22	2.27	2.32	2.37	2.42	2.47	6.57 Kn
Up to 6m	2	1.77	1.82	1.87	1.92	1.97	2.02	2.07	2.12	2.17	2.22	7.32 Kn
Up to 6m	1	1.42	1.47	1.52	1.57	1.62	1.67	1.72	1.77	1.82	1.87	4.88 Kn

Legend

- Cp** = required minimum clearance below the platform
- E** = fall safety Margin of at least 1m (3.3')
- FFD** = free-fall distance-the vertical displacement of the fall-arrest attachment on the harness from the time a fall begins until the moment just before the system begins to react by applying force to arrest the fall
- Hd** = height of D-ring above the platform when the worker is standing*
- Hf** = height of D-ring above the worker's toes at fall arrest (= Hd + xh)
- Ly** = length of lanyard
- MDD** = maximum dynamic deflection of the horizontal lifeline (see table below)
- S** = initial sag of the horizontal lifeline
- xs** = extension of shock absorber (and/or lanyard stretch)
- xh** = harness stretch

*An Hd of 1.5 m (5 ft) may be assumed for a user 1.8 m (6 ft.) tall.

Note: Some factors that affect the calculation of minimum clearance include free-fall distance, initial lifeline sag, maximum dynamic deflection, the length of the lanyard or lifeline, lock-off and clutching of self-retracting lanyards, deployment of personal shock absorbers, harness stretch, and the fall-safety margin.

- KeeLine® Overhead should be placed above fall hazard to minimise swing falls.
- Do not allow more than two users on the system.

5 INSTALLATION

Installation should only be carried out once all the design has been verified in the KeeLine® II Calculator and the installer has been fully trained by Kee Safety.

5.1 Tool List

- ☐ Ratchet
- ☐ 12mm A/F Socket
- ☐ 19mm A/F Socket
- ☐ 19mm A/F Spanner
- ☐ 24mm A/F Spanner
- ☐ 3/16" INHEX Socket (For S5 Clamp Fixing)
- ☐ 27mm Hole Saw (for Metal work)
- ☐ 35mm Hole Saw (for Metal work)
- ☐ 250mm Extension for Hole Saw
- ☐ Torque Wrench
- ☐ Long Arm Rivet Gun to suit 6.4mm (1/4") Dia. Blind Rivets.
- ☐ Electric / battery powered Drill
- ☐ Ø 6.7mm HSS Drill Bit
- ☐ Measuring Device (tape measure, laser measure, etc.)
- ☐ Wire Cutters
- ☐ Swaging Tool and unique swaging die (when using swage end terminations)
- ☐ Swage Testing Tool (Up to 20kN)
- ☐ Permanent Marker Pen
- ☐ Scissors / Knife (for cutting sealing strip)
- ☐ Additionally, specific to the KeeLine Overhead system
- ☐ 13mm A/F Socket
- ☐ Suitable Drill Bits dependent on the fixing substrate
- ☐ Lightweight lever hoist
- ☐ Rope gripping clamp
- ☐ 6mm (1/42") dia. bar or screwdriver shank

5.2 Baseplates

Please be aware of the requirement to offset the location of the Baseplates where possible to ensure the wire runs square to the intermediate and corner brackets.

a) Trapezoidal Roof Types & Standing Seams

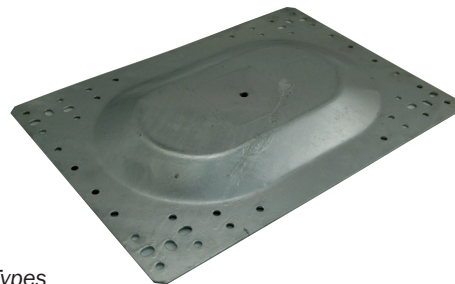

Figure 1 - A Baseplate for use on trapezoidal Roof Types

DANGER TO LIFE!



- ☐ **Do not install into Steel roof sheets less than 0.7mm thick. If in doubt, do not install using rivets. See advice from Kee Safety Technical Department.**
- ☐ **Ensure that the baseplates are located at least 2m from any roof edge or opening.**

Built Up Roof Style (0.7mm THK Steel Minimum)

- ☐ Identify where the baseplates should be located on the structure. See note above.
- ☐ Align the baseplate so that at least twelve of the round 9mm diameter holes are aligned with the crowns of the sheeting; see diagram below.

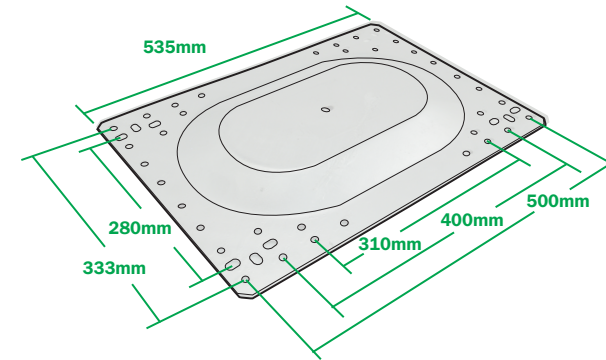

Figure 2 - Baseplate to suit Trapezoidal Roof with 310mm, 333mm, 400mm & 500mm profile

- ☐ Cover these holes on the underneath of the Baseplate with the recommended double sided sealing strip. Remove backing tape before going onto next stage.
- ☐ Align the baseplate holes with the crowns of the roof.
- ☐ Press the Baseplate down into position.
- ☐ Use a drill of diameter 6.7mm to drill through identified holes (a minimum of twelve in total) i.e. 3 fixings per corner.
 - Note: Roof Insulation may protrude through the holes during the drilling process. This can be pushed back into the holes.
- ☐ Fix the recommended Kee Safety rivets into the drilled holes.
 - **Kee Safety rivets supplied by Kee Safety are the only rivets permitted for installation.**
 - Follow the guidelines given with the Rivet Installation Tool.

Composite Roof Style (0.7mm THK Steel Minimum)

- ☐ Follow the same method as above but drill an additional hole through the pre-drilled holes so that there are three Rivets in each corner.
- ☐ The Base is pre-drilled with additional Holes to suit roof crowns of 333mm & 500mm centres.

Standing Seam Roof Type Fixing Detail

- A post must be used at all extremities, intermediates and corners
- The base is pre-drilled with additional holes to suit 300mm, 400mm & 500mm centres.
- Identify which slotted holes align with the standing seams of the roof and then loosely fit the standing seam clamps onto the seam.
- When in position, tighten the grub screws to the recommended torque of 15 Nm
- The baseplate slots can then be lined up with the tapped holes in the clamps and the hexagon head screw supplied can be fixed down to the recommended torque of 25 Nm
- There should be one clamp at each corner of the baseplate.

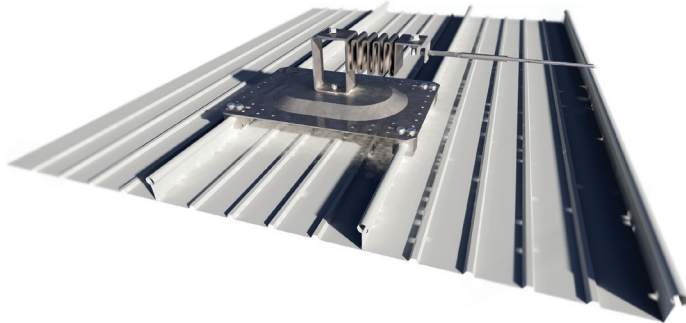

b) Membrane Roof with Insulation and Steel / Timber Decking

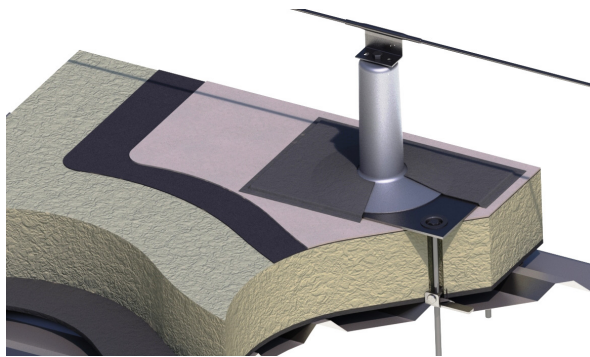

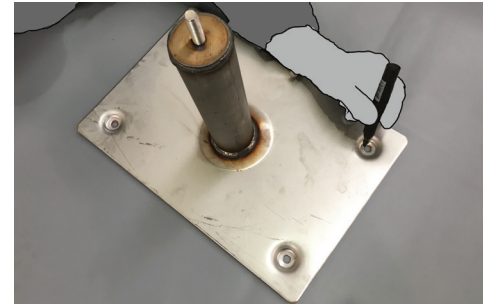

Figure 3 - Baseplate for Membrane Roof Types

DANGER TO LIFE!

 **Do not install into Ply Timber deck sheets less than 18mm or trapezoidal liner sheets less than 0.7mm thick. If in doubt, do not install. Seek advice from Kee Safety Technical Department. Ensure that the Baseplates are located at least 2m from any roof edge or opening.**

 **Toggle Bolts can be fitted to roofs with an insulation thickness of 50 – 230mm.**
 □ Identify where the Baseplates should be located.



a) Position the Standard Flat Roof Post (LAKL2POST) in the required position on the roof. (Note:- orientate the post to ensure the extremity and corner posts have the three holes as shown). Intermediate posts can be orientated in any direction. Using a marker pen or hole punch, mark the position of the holes and remove the post.

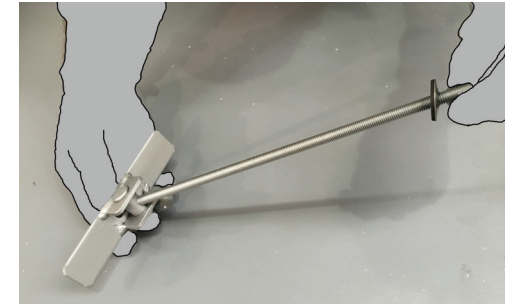

b) Dismantle the toggle bolts (LAKL2TOG2) and fit them to each corner of the Standard Flat Roof Post (LAKL2POST)

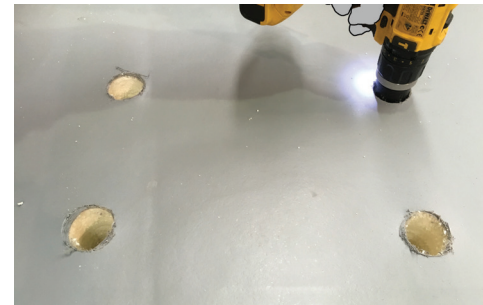

c) Using a 48mm diameter progressor hole saw/arbor cut through the roofing membrane, insulation and deck material to expose the underside of the roof construction.



d) Carefully lift the post with fitted toggle bolts attached and offer the toggle bolts (LAKL2TOG2) into the pre-drilled holes through the roof.

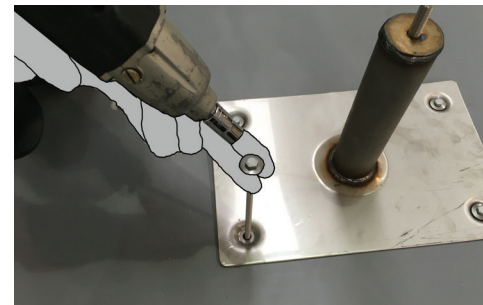

e) Ensure all the toggle bolts are fully pushed through the roof structure. Holding the threaded toggle bolt pull it in an upwards direction so it engages against the underside of the roof decking. Tighten the toggle bolt in a clockwise direction using a 13mm spanner or socket. Repeat this for the remaining toggle bolts.



f) Once tightened torque to 8 Nm to ensure they are all fitted correctly. Fit the selected weather proof cowling and complete the required weatherproof detail. (Note:- This may be a specialist roofing contractor).

System Layout Planning, Assembly & Installation

c) Concrete

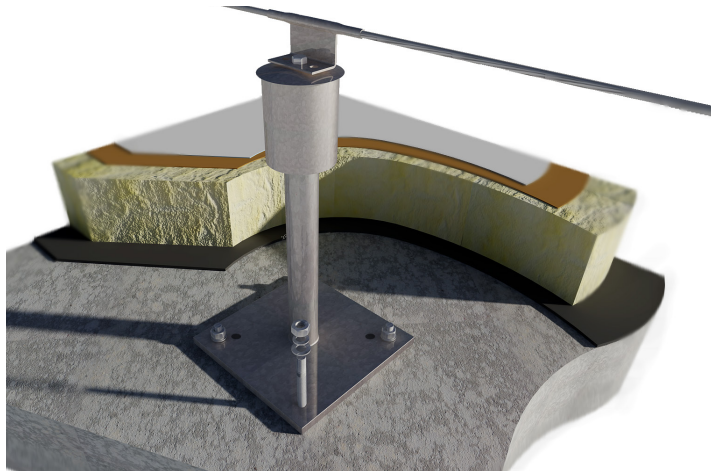
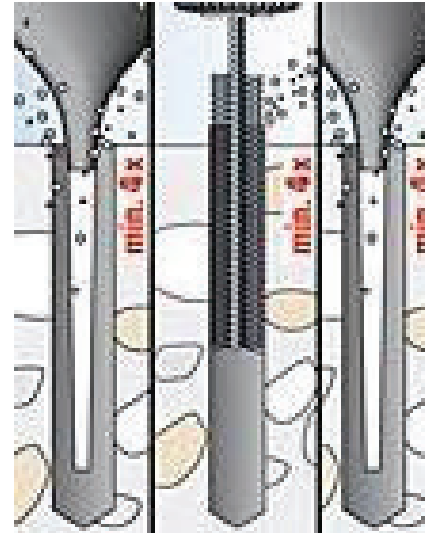

Figure 5 - Baseplate for Fixing to Concrete Structures

- Identify where the posts should be located.
- Ensure that the Baseplates are located at least 0.5m from any roof edge or opening.
- Use the Baseplate to help mark the locations for the structural resin anchors.

i) Drill four (4) Ø10mm holes 95mm deep. Thoroughly clean the hole of dust and debris using a wire brush and a pump or vacuum



ii) Insert one resin capsules into each hole. Ensure the air Bubble inside the capsule is facing upwards.



iii) Insert one stud into each hole using a hammer action drill. Switch off drill **immediately** when the hole base is reached **IMPORTANT:** Each stud must be inserted using a twisting action with a hammer drill. These components **CANNOT** be installed simply using a hammer or other method to drive the stud into the structure.

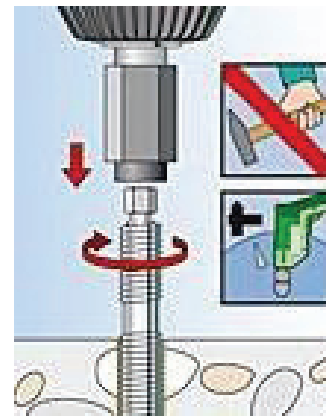

iv) Wipe the excess resin clear and leave for the recommended time given in the table below.

Concrete Temperature	Minimum Curing Time*
-5°C to -1°C	4 hours
0°C to 9°C	45 minutes
10°C to 20°C	20 minutes
>+20°C	10 minutes

After the curing time has passed, place the Baseplate over the studs and tighten the nuts to the recommended torque (see Fischer recommendations).

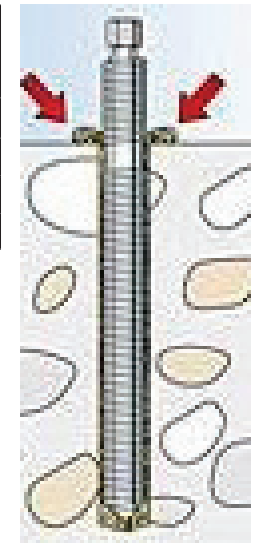

5.3 Posts

a) Post Installation for Trapezoidal Roofs

- A post must be used at all extremities, intermediates and corners.
- Extremity Posts – 200 x 100mm Rectangular Tube
- Corner and Intermediate Posts – 100 x 100mm Rectangular Tube



Figure 7 - Extremity and Intermediate/Corner Posts

- Fit the designated posts to the baseplates using an M12 x 20mm Grade A4-80 set screw, spring washer and flat washer (supplied).

NOTE: The spring washer should be placed between the flat sealing washer and the screw head.

- Tighten to a torque of 39Nm.
- When fitting to the membrane base plate we suggest wrapping the thread of the mounting set screw with plumbers PTFE Tape (Available separately) before fitting to aid waterproofing.
- **Important:** Always use a sealing washer when fitting to a membrane roof type.

b) End Deformation Support Post

- This post provides a standard method of connecting the system directly to the Base Plate.
- Material : Galvanised steel to BS EN ISO 1461. Net weight : 1.8Kg.

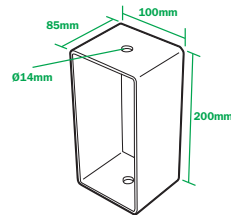

c) Intermediate and Corner Deformation Support Post

- This post provides a standard method of connecting the system directly to the Base Plate.
- Galvanised steel to BS EN ISO 1461. Net weight : 0.974kg.

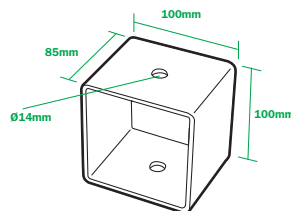

5.4 System Plaque

- Provides details of the system and approvals.
- Material : plastic. Component weight : 0.085kg.

<p>RESTRAINT SYSTEM SEPARATING PEOPLE FROM HAZARDS</p> <p>HEAD OFFICE Kee Safety Limited Cudby Business Park Charnock Road Cudby Heath West Midlands B66 7DW</p> <p>Tel: +44 (0) 1384 632 180 Fax: +44 (0) 1384 632 192 Email: info@keesafety.co.uk Web: www.keesafety.co.uk</p> <p>RE-TEST ONLY TO BE CARRIED OUT BY AUTHORISED SERVICE AGENT.</p>	SYSTEM NUMBER	<input type="text"/>
	INSTALLATION DATE	<input type="text"/>
	MAX NUMBER OF USERS	<input type="text"/>
	LAYARD LENGTH NOT TO EXCEED	<input type="text"/>
	ANNUAL INSPECTION RECOMMENDED	<input type="text"/>

<p>FALL ARREST SYSTEM SEPARATING PEOPLE FROM HAZARDS</p> <p>HEAD OFFICE Kee Safety Limited Cudby Business Park Charnock Road Cudby Heath West Midlands B66 7DW</p> <p>Tel: +44 (0) 1384 632 180 Fax: +44 (0) 1384 632 192 Email: info@keesafety.co.uk Web: www.keesafety.co.uk</p> <p>RE-TEST ONLY TO BE CARRIED OUT BY AUTHORISED SERVICE AGENT.</p>	SYSTEM NUMBER	<input type="text"/>
	INSTALLATION DATE	<input type="text"/>
	MAX NUMBER OF USERS	<input type="text"/>
	LAYARD LENGTH NOT TO EXCEED	<input type="text"/>
	ANNUAL INSPECTION RECOMMENDED	<input type="text"/>

5.5 Extremity Assemblies

a) Absorber

- An absorber needs to be placed at each extremity of the KeeLine® II system.
- This will be fitted to the post using one grade A4-80 M12x30mm set screw, flat washers and M12 NY-LOC Nut and shall be tightened to a torque of 39Nm.

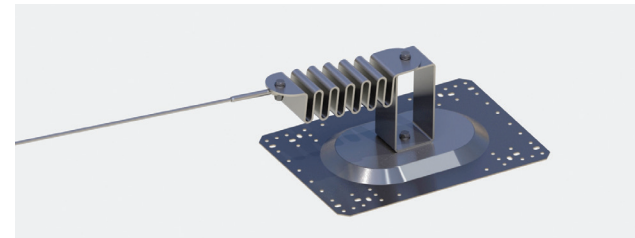

Figure 8 - Baseplate, Extremity Post & Absorber

b) Tensioner Unit

- There must be at least one Tensioner Assembly in the KeeLine® II system.
- This number will increase to two Tensioner Assemblies if the total system length is over 150m.
- The Tensioner Assembly fits to the Absorber using one Grade A4-80 M12x60mm Set Screw and flat washer. This is screwed in through the top of the Absorber. The Tensioner is then fixed to the underside of the absorber using an M12 Nyloc Nut, and shall be tightened to a torque of 39Nm.

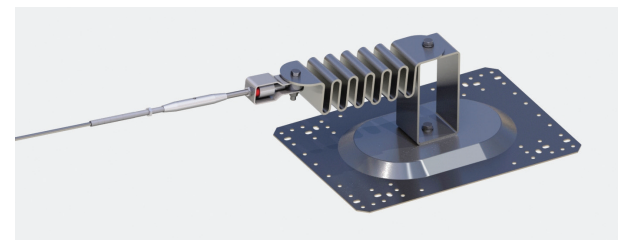

Figure 9 - Extremity Post Assembly with Tensioner

c) Swaged / Swageless End Termination Fixing Bracket

- There is normally one 'End Termination' in the KeeLine® system (either swaged or swageless). This number is reduced to zero if the total system length is over 150m, where it must be replaced with a Tensioner Assembly.
- The End Termination fits to the **underside** of the Absorber using one Grade A4-80 **M12x40mm** Set Screw, flat washer and M12 Nyloc Nut.
- The screw is screwed into the Absorber from above, along with a flat washer.
- The nut shall be tightened to a torque of 39Nm.

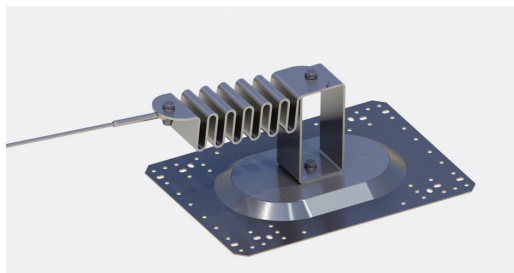

Figure 10 - End Termination Attached to the Fixing Bracket

5.6 Intermediate Assemblies

- Intermediate post assemblies must be placed at intervals of between 5m (minimum) or 15m (maximum).
 - **Ensure the Kee Line calculator is used when designing the system layout.**
- Intermediate brackets are fixed to the top of intermediate posts using one Grade A4-80 M12x30mm set screw. This shall be tightened to a torque of 39Nm.

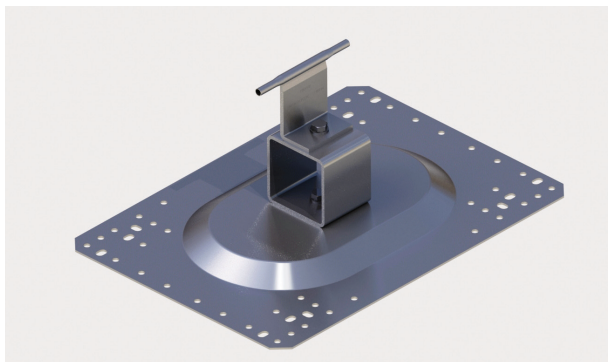
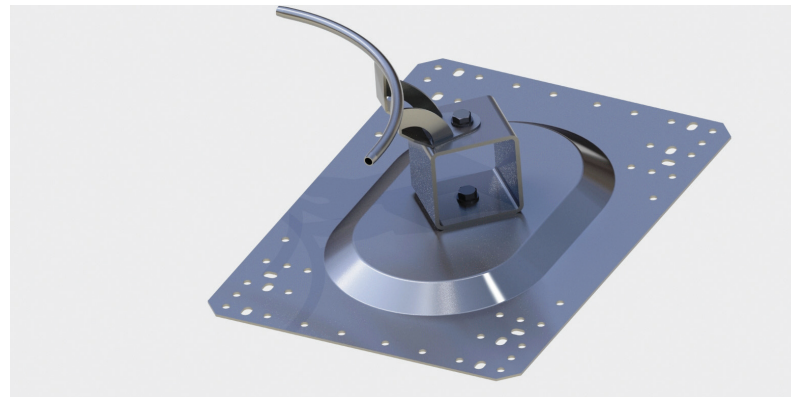

Figure 11 - Baseplate, Intermediate Post and Intermediate Bracket

5.7 Corner Assembly

a) 90° Corner Assembly

- Allows the system to turn through 90° or 135° Other angles can be achieved via cutting the tube in order to form the required angle.
- Material : Stainless steel AISI 316L. Ø 13.5mm. Net weight : 0.46kg.



b) 45° Corner Assembly

- Allows the system to turn through 90° or 135° Other angles can be achieved via cutting the tube in order to form the required angle.
- Material : Stainless steel AISI 316L. Ø 13.5mm. Net weight : 0.388kg.

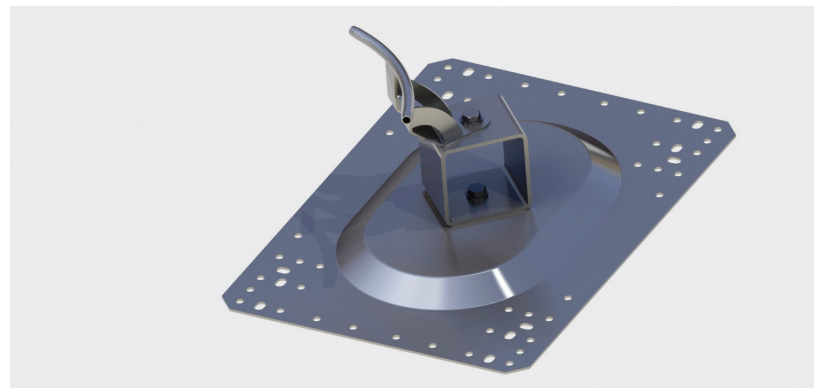

System Layout Planning, Assembly & Installation

5.8 Wire Installation

NOTE: The wire used shall be stainless steel wire, Ø8mm, 7x7 construction. The minimum breaking load shall be 3,800kg.

a) Installing the Wire

- Once all extremity, corner and intermediate brackets are assembled and fitted, the wire can be joined (Swaged or Swageless) at the End Terminal Post Assembly. The End termination is fitted to the Absorber using the two nuts, the Full Nut and the Lock Nut. The full nut and lock nut must both be behind the fixing bracket, NOT one either side of the bracket.
- The wire can now be passed through all of the intermediate and corner assemblies and then pulled taught towards the Tensioner Post Assembly.
- Support the wire in two places of the last span if the span length is greater than 12m.
- The wire shall be marked for length to fit the final Left Hand END Terminal included in the Tensioner assembly.
- Approx. 90mm of wire will be inserted into the End Terminal. This can be checked and marked by inserting the cable, marking it and removing it, then marking the swage by placing the cable alongside.
- This End Termination can be removed from the Tensioner Assembly and the wire fitted
- Every swaged termination **MUST** be tested before assembly. Refer to section.
- The swage should then be screwed back into the Tensioner Assembly.

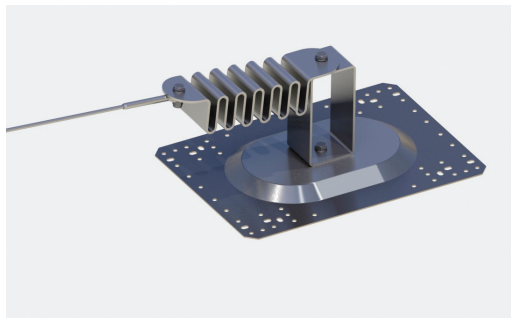

End Termination Attached to the Fixing Bracket



Overhead End Termination attached to Structure

b) Tensioning the Wire

- The wire in the system is tensioned by screwing the Turnbuckle until the barrel of the tension indicator cone meets the inside face of the clevis and the red indicator is no longer visible. When tensioning, ensure that the wire does not twist with the turnbuckle.
- The lock nuts shall then be tightened to prevent the assembly becoming loose and the wire slack.

NOTE: The lock nuts need to be screwed tight to the 'Turnbuckle'.

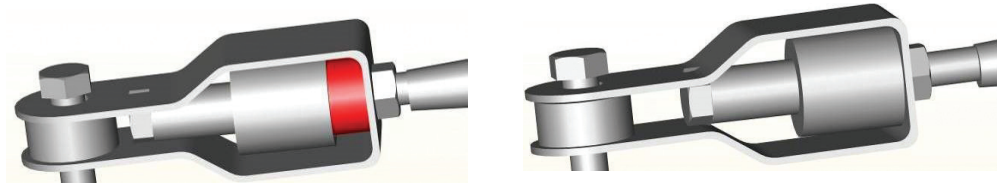

Figure 20 - Un-tensioned Tension Indicator

Figure 21 - Correctly tensioned Tension Indicator

The threads of both the **End Terminals** and the M12x150mm bolt of the **Tensioner** must be sufficiently engaged to completely obscure the inspection holes in the turnbuckle.

For systems 150m or longer, there must be a **Turnbuckle** at each end of the wire rope to ensure correct line tension.

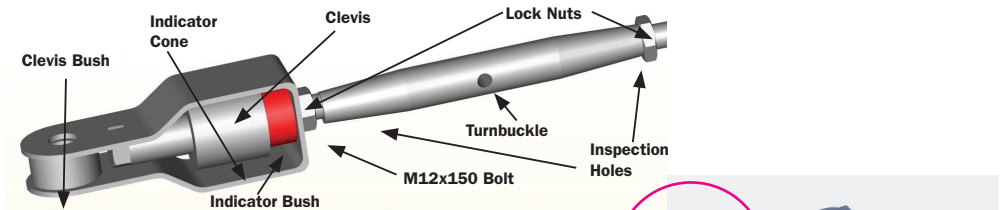
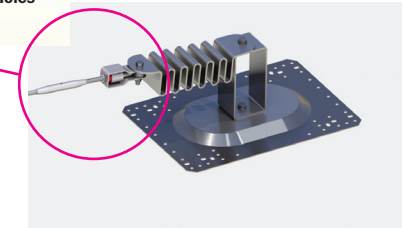

Figure 22 - Tension Indicator Assembly with Turnbuckle



c) Swaged Tensioner Assembly and End Terminals – Swaging the wire

The swage fitting should be crimped directly to the wire using four crimps, spaced as shown Figure 23, ensuring the first swage is at the end of the swage (to the left of Figure 23), then proceeding right towards the threaded end. The bites shall be placed in **BETWEEN** the light scoring marks on the swage, not on the marks.

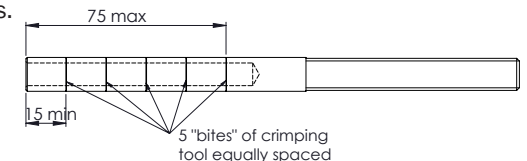
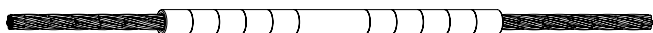

Figure 23 - Position of Crimps When Swaging KeeLine® Terminals

System Layout Planning, Assembly & Installation

The minimum and maximum dimensions shown in Figure 23 MUST BE OBSERVED. Bites outside the indicated area could reduce system strength. Every swaged termination MUST be tested before assembly.

Only use the recommended tool for this purpose. Special swaging dies have been developed to ensure adequate grip is obtained from the handheld swaging press. If using any other swaging or crimping tool, consult the tool manufacturer to ascertain sufficient grip is obtainable. If it becomes necessary to 'join' two lengths of wire, the use of a Rope Connector supplied by Kee Safety is recommended. The rope connector swages the wires following the same process as for the Swage Terminations.



Rope Connector

d) Swageless Tensioner Assembly and End Terminals – Swageless fittings



LH Thread Swageless Fitting

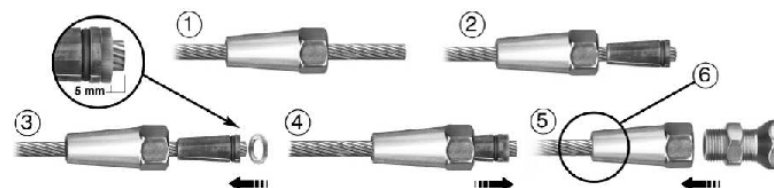

Remove the Swageless End Termination from the Tensioner Unit where relevant.

- Slide the jaw housing in place on the cable.
- Then slide the jaws onto the cable, ensuring there is equal space between the jaw sections.
- Place the brass pressure ring on the end of the cable, making sure that the distance from the pressure ring to the end of the cable is 5 mm.
- Slide the jaw housing over the jaws.
- The terminal can now be assembled. Screw the head firmly onto the jaw housing with a spanner. Then tighten the lock nut firmly with a spanner.
- Seal with a non-acidic sealing compound during assembly e.g. Sikaflex-221. Disassemble the terminal and fill the jaw housing and the cavity with sealing compound, then assemble the terminal again. Repeat this until the sealing compound emerges from the hole through which the cable is inserted. Clean the terminal.

5.9 Postanka Mounted Systems

Where it is intended to mount KeeLine® II on roof mounted posts, consult Kee Safety with regards to the type and size of posts which are suitable for extremity, corner and intermediate fixing. Information you will need supply shall include AT LEAST the following:

- Pedestal Type
If you are unsure of this, details of the roof structure will enable Kee Safety to advise you of the most suitable type.
- The structure to which the Postanka is to be fixed to.
- The dimensions of the roof member (where relevant).
- The height of the wire system above the roof member or fixing surface. The maximum forces that will be experienced in the cable when simultaneously arresting the falls of the **MAXIMUM NUMBER** of users permitted on the system.

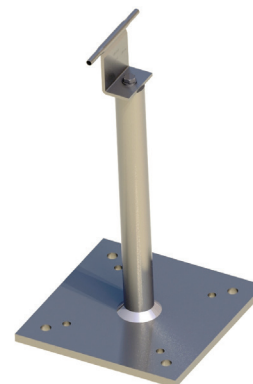

Figure 24 - KeeLine® fitted to Postanka

5.10 Wall & Steelwork Mounted Systems



Figure 24 - KeeLine® fitted to Postanka

a) Extremity Bracket

Brick & Concrete

- First establish the height of the finished system, and the position of the extremity fixings.
- The **Extremity Bracket** has two holes on one side and three on the other. The side of the bracket with two holes is fixed to the structure.
- These two holes are spaced at 200mm centres, ensuring fixings into two separate bricks.
- The **Extremity Bracket** is fixed using M12x100mm Grade A4-80 Set Screws screwed into resin bonded knurled inserts available from.
- For sound concrete and brick, 100mm long knurled inserts are sufficient. For all other aggregate material, a minimum of 120mm inserts should be used. If you are unsure of the strength of the structure, tests should be carried out to verify the structures suitability.

DANGER TO LIFE!



Only Knurled Inserts available from Kee Safety are suitable for this application and should be installed as per the instructions for use for that product.

b) Absorber – Brick, Concrete & Steelwork

The Absorber is fastened to one of three holes available on the top surface of the Extremity Bracket. It is fastened using an M12x30mm grade A4-80 Set Screw, Flat Washer and M12 Nyloc Nut. See 5.5a)

c) Tensioner Unit

See 5.5c)

d) End Termination

See 5.6 Structure Mounted Intermediate Brackets

- The Intermediate brackets are fixed using 1 x M12x100mm Grade A4-80 Set Screw. This is screwed into resin bonded Knurled Inserts available from Kee Safety.
See CAUTION! below.
- For sound concrete and brick, 100mm long knurled inserts are sufficient. For all other aggregate material, a minimum of 120mm inserts should be used. If you are unsure of the strength of the structure, tests should be carried out to verify the structures suitability.
See CAUTION! Below.

DANGER TO LIFE!



Only Knurled Inserts available from Kee Safety are suitable for this application and should be installed as per the instructions for use for that product.

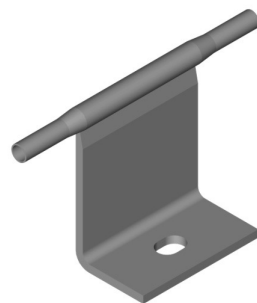

Figure 25 - Structure Mounted Intermediate Bracket

e) 90° and 135° Wall Mounted Corner Assemblies

- These Assemblies consists of one curved tube to 90° or 135° angles.
- The straight tubes of the **Intermediate Bracket** have machined ends and fit into the counter bored ends of the curved tube.
- To assemble, slide the (slack) **Cable** through first one straight section of Straight Rope Guide, then the curved section, and finally the second Straight Rope Guide.
- The assembly can then be offered up to the wall, and the required positions for the holes for the knurled sockets marked out. Proceed to resin bond knurled Inserts in accordance with the relevant instructions for use, and in consideration of BS7883. **See CAUTION! Below.**
- For sound concrete and brick, 100mm long knurled inserts are sufficient. For all other aggregate material, a minimum of 120mm inserts should be used. If you are unsure of the strength of the structure, tests should be carried out to verify the structures suitability.
See CAUTION! Below.

DANGER TO LIFE!



Only Knurled Inserts available from Kee Safety are suitable for this application and should be installed as per the instructions for use for that product.

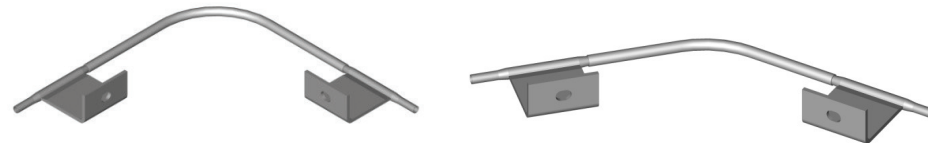

Figure 26 - 90° and 135° Corner Assemblies

f) Wire Installation

The procedure for fitting the wire and tensioning the system is the same as that described in

g) Other mountings

These Assemblies consists of one curved tube to 90° or 135° angles.

DANGER TO LIFE!



Compatibility with other manufacturers integral structural anchorage or anchor devices is not implied.

If mounting KeeLine® on other anchor devices, obtain confirmation of testing for compatibility from manufacturer. Familiarisation.

5.11 Single Point Anchor Assembly

At certain times there is a need for an anchor point onto which a single user can attach themselves with the appropriate PPE. Using the KeeLine®II baseplate and post it is possible to have such a device. The assembly is supplied with a Karabiner. When attaching to a single point anchor assembly the user must ensure that an energy absorbing device or system to EN 355 forms part of the PPE combination should the possibility of the system having to arrest a fall be likely.

The single point anchor assembly is intended for applications where in the event of a fall, the loading applied to the single point anchor assembly would be in any direction along or across the roof surface. The assembly should be positioned so that the user can either attach before attaching onto a horizontal safety line or attach before disconnecting from a horizontal life line to ensure they are always attached in an area where a fall could occur.

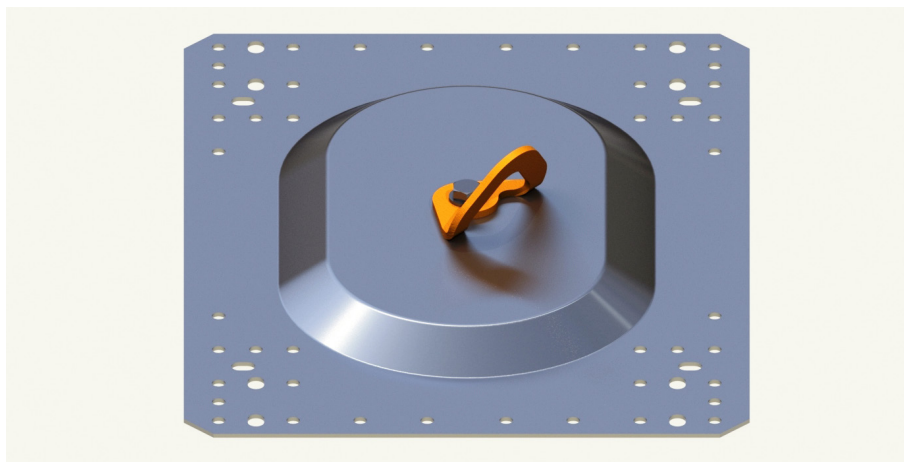

Positioning

Trapezoidal metal roofs at least 0.7mm thick and above with crowns at 333mm & 500mm centres require the baseplate to be fitted as per the wire variants, such that the fixing rivets are positioned centrally into the crowns of the roof sheets and use three rivets per corner.

Standing Seams with seams at 300mm, 400mm & 500mm centres require the baseplate to be fitted using a single S5 clamp in each of the four corners utilising the four slotted holes provided.

Membrane roofs with insulation require the post to be fitted for this roof type contained in this manual.

Concrete roof surfaces require the Postanka to be fitted for this roof type contained in this manual.

5.12 Installation of the KeeLine Overhead System

All M12 fixings should be tightened to a torque of 39NM

STEP ONE: Fix Extremity brackets to the structure both ends of the system. Connect absorbers to Extremity brackets both ends of the system. (see section 5.8 (a) for reference).

STEP TWO: Connect intermediate brackets to structure, ensure intermediate brackets wire guide are in-line with the centre of the Tension Indicators and other Intermediate Brackets in the system if used ensure fixing centres do not exceed requirement to maintain safe free fall distance.

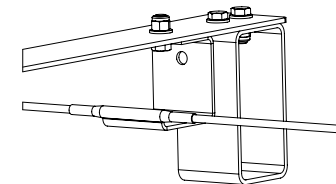

STEP THREE: Swage one end of the wire to either a swage assembly or tensioner assembly, it is recommended that on systems above 24m in total length a tensioner assembly is used at both ends of the wire system to assist with obtaining correct 3kN line tension. Once swaged, the assembly can be connected to the absorber at one end of the system (see section 5.8 (b & c) for reference).

STEP FOUR: Slide KOTEN travellers onto the wire, ensure they are orientated correctly to allow them to pass the intermediate brackets (see drawing to right). Maximum angle that the bracket can be fixed to should not exceed 5 degrees from the horizontal.

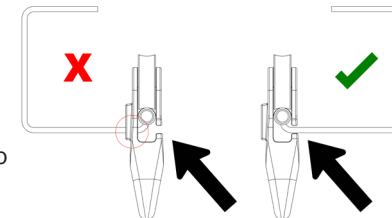

STEP FIVE: Slide wire through intermediate brackets if used. Pull wire tension through each span, clamp wire after each intermediate to minimise amount of slack required to be removed by tensioner(s) at the ends of the system if no intermediates are used see Step Seven.

STEP SIX: Using a propriety rope gripping clamp and lever hoist (see drawing to right) attached to the structural steel work or other suitable anchor, grip the wire rope behind where the wire is to be cut and pull as much tension through the system as possible, allow rope gripper and lever hoist to hold wire, measure (see Section 5.8 (b, c & d) for reference) and cut wire rope to length and swage to tensioner/swage assembly.

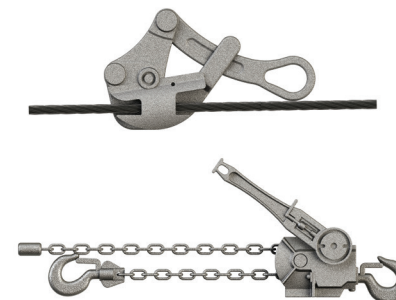

STEP SEVEN: Tension system, check both tensioner/swage assemblies that tensioners have sufficient thread engagement and check and torque all fixings.

STEP EIGHT: Ensure any signage/markings can be seen by user at point of connection to the system.

Ensure any signage/markings can be seen by user at point of connection to the system.

6 GENERAL GUIDANCE FOR USING KEELINE

6.1 General

The safety of users depends upon the continued efficiency and durability of their equipment. It is recognised that checks, inspections and examinations are a contributory factor in reducing risks. It is essential, therefore, that these inspections and examinations are carried out as recommended, and as required by any national regulations.

Only persons competent to do so should carry out pre-use checks, inspections and examinations. A competent person is defined as a designated person who is knowledgeable of the current checking, inspection and examination requirements, recommendations and instructions issued by the manufacturer applicable to the relevant component, subsystem or system. This person should be capable of identifying defects, should be responsible for initiating the corrective action to be taken and should have the necessary skills and resources to do so.

Once in place at the worksite, KeeLine® II (and the rest of the system) should be checked before each use (Pre-use check) to ensure that the whole system functions correctly.

After every week of constant use, every six weeks of intermittent use and on each occasion of re-assembly, before they are used again, KeeLine® II should be more closely inspected, e.g. for signs of damage, to ensure that it is safe for re-use. This inspection (i.e. interim inspection) should be recorded. See the example of a form for periodic examination and repair history at section 0.

At least every twelve months there should be a thorough examination (i.e. a detailed inspection, more thorough than the interim inspection). This thorough examination should also be recorded.

6.2 Exclusion Zone

It is first necessary to establish an exclusion zone between the Kee Line and the roof edge, into which no one should be allowed unless connected to Kee Line (or other appropriate anchor, if one exists). Some form of marking or barrier should designate the exclusion zone.

Connection may be:

a) directly to the horizontal line system using a lanyard to EN 354 or EN355, of a length that will not allow the user to reach zones where the risk of a fall exists (for qualification as a restraint system), or

b) directly to the horizontal line system using a lanyard to EN 354, EN355 or EN358, of a length that will allow the user to reach within 500mm of the roof edge (fall arrest system).

6.3 Number of Users

Type Of Roof	Number Of Users	Maximum Spans Between Posts	No. Of Fixings per Base Plate
	Fall Arrest or Restraint	Fall Arrest or Restraint	
> 0.7mm Profiled Steel Sheet	3	12	12 Rivets
Membrane (Steel/Timber Deck)	3	12	4 Toggle Fixings
Membrane (Concrete Deck)	3	12	4 Studs & Resin Capsules
Standing Seam	3	12	4 Standing Seam Clamps
Composite	3	12	12 Rivets
Concrete	3	12	4 Studs & Resin Capsules
Structures (Brick, Concrete & Steelwork)	3	12	A40-80 Set Scrs + Nuts / Sockets / Resin Capsules

6.4 Pre-use Checks

Only persons competent to do so should carry out pre-use checks. A competent person is defined as a designated person who is knowledgeable of the current checking requirements as defined by the manufacturer. This person should be capable of identifying any defects and instigating any corrective actions required and should have the necessary skills and resources at their disposal to do so.

a) Before 1st Use

Make a final inspection of the assembled KeeLine® II. Ensure that all the instructions for their assembly and location have been followed.

Particularly:

- that the KeeLine® II is positioned at the correct distance from the roof edge as used in the system calculation.
- that the maximum span between structural anchors does not exceed the value used for calculation.
- that all bolts and nuts are correctly torqued as indicated in relevant sections of this document.
- all points below (0)

The assembly of the KeeLine® II is now complete.

b) Pre-use check

Before each use of this equipment, including after initial assembly, carry out a pre-use check to ensure that it is in an acceptable condition and that it operates correctly. This includes the whole horizontal line system. This check should include at least the points below:

- The available fall distance below roof lights or at the perimeter of the building has not been reduced by alterations to the height of internal or external racking or, for example, the introduction of new protrusions from the vertical face of the structure by the introduction of additional buildings, plant, storage equipment etc; by the opening of windows; or by vehicular or pedestrian traffic.
- There has been no slippage of the cable in the swaged terminals.
- The system is correctly tensioned as in section
- There is no visible wear amounting to a reduction of cross sectional area to any strands of the cable at any point.
- All fixing bolts are still tight and locknuts secure.
- A warning sign is visible at each end of the system to indicate that it is only for the attachment of PPE fall arrest equipment and indicating the maximum number of users permitted to attach to that particular system at any one time.
- There is no indication of any fall having been arrested by the system. Evidence may include extension of the Absorber.
- The Traveller device to be used on that occasion is the correct model and is free from defect and/or debris which might prevent any moving part from doing so.
- If using the KeeLine® II Traveller, it has been fitted to the rope and the push button been engaged so the traveller cannot be removed accidentally. See Figure 27.
- A secure connection (to EN362) has been made between the traveller device and the lanyard, following the instructions for use for said connector.
- There is no damage or defect to any part of the KeeLine® II components
- Any recommendations for use with other components in the system, as advised on the record card, are complied with.
- There is no damage to the roof which KeeLine® II is installed on to.
- Oil, grease or any other substance has contaminated neither the roof surface nor the KeeLine® II.
- Any instructions issued by manufacturers of combined components have been met.

6.5 Attaching the Traveller

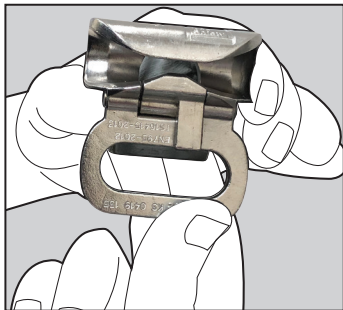

1) Take the traveller in one hand.

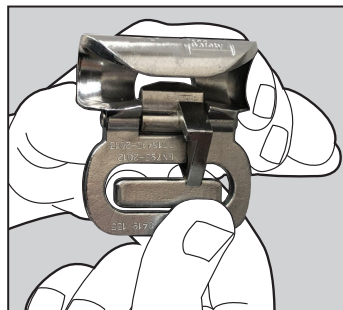

2) With the other push the pin in and open the traveller.

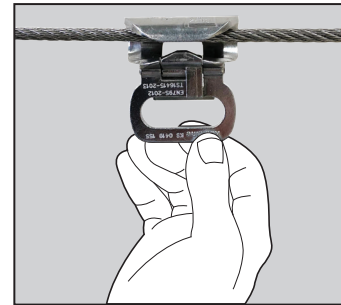

3) Place the traveller on the Horizontal Life Line.

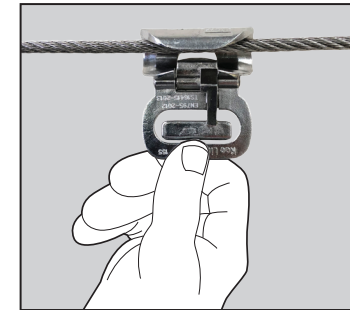

4) Close the traveller, the pin will now re-engage.



5) Place the karabiner through the traveller



6) Ensure that all locking devices are closed within the karabiner

- Once connected to the system, the Traveller device should pass freely over all intermediate and corner anchorage points, allowing free movement over the whole system.
- If excessive resistance is encountered, adjust the angle and speed of approach of the Traveller device by holding the lanyard in one hand.

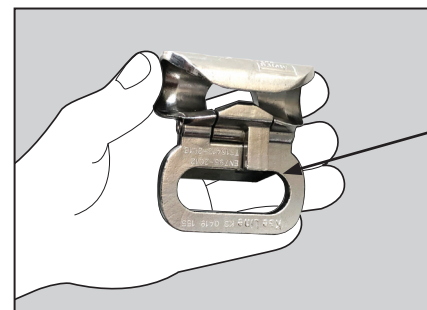

Figure 27 - KeeLine® II Traveller

Attachment Point

DANGER TO LIFE!

The Traveller should not be used upside down.



6.6 System Plaques

The supplied **SAFETY** information plaques must be attached at each 'entry / access' point of the system. They may be affixed directly to the system or to the nearby structural anchor. In either case the pointing hand should show which system the label refers to.

DANGER!



Where more than one system shares an anchor device, installers must ensure that labels could not be exchanged or re-orientated to indicate different systems. Other systems may have been designed to different requirements.

7 EXAMINATION, MAINTENANCE & STORAGE

7.1 Instructions for Periodic Examination

What to look for during inspections and thorough examinations? The lists below are not exhaustive.

a) Interim Inspection

An inspection should be carried out after every week of constant use, every six weeks of intermittent use and on each occasion of re-assembly, and recorded. In addition to the pre-use checks at section 0, inspect for signs of corrosion beyond normal tarnishing, wear, distortion or other defects on all parts including bolts and nuts.

DANGER!



Should any doubt arise about the safety of any part of the system, do not use it and remove it from service immediately and seek advice from your KeeLine® supplier.

b) Thorough / Detailed Examination

Only persons competent to do so should carry out thorough and detailed examinations.

- A thorough examination should be carried out at least every twelve months and recorded.
- Check that there is no wear or distortion of the holes through which the cable or various bolts are passed when assembling the KeeLine® II components.
- The available fall distance below roof lights or at the perimeter of the building has not been reduced by alterations to the height of internal or external racking or, for example, the introduction of new protrusions from the vertical face of the structure by the introduction of additional buildings, plant, storage equipment etc; by opening of windows; or by vehicular or pedestrian traffic.
- There has been no slippage of the cable in the swaged / swageless terminals. Kee Safety recommends the use of a proprietary swage testing device and the terminal accepting a 10 KN pull test for three minutes.
- The system is correctly tensioned.
- There is no visible wear amounting to a reduction of cross sectional area to any strands of the cable at any point.
- All fixing bolts are still tight and locknuts are secure and correctly torqued up.
- Warning signs to indicate that it is only for the attachment of appropriate PPE fall arrest equipment and indicating the maximum number of users permitted to attach that particular system at any one time are visible and legible.

- There is no indication of any fall having been arrested by the system. Evidence may include extension of the absorber.
- The Traveller device to be used on that occasion is the correct model and is free from defect and / or debris which might prevent any moving part from doing so.
- If using the KeeLine® II Traveller, it has been fitted to the rope and the push button engaged so the traveller cannot be removed accidentally. See 4.5 Method of use.
- A secure connection (EN362) has been made between the traveller device and the lanyard, following the instructions for use for said connector.
- There is no damage or defect to any part of the KeeLine® II components.
- There is no damage to the structure which the Keeline® Overhead system is installed into.
- Any recommendations for use with other components in the system, as advised on the record card / commissioning certificate, are complied with.
- There is no damage to the roof which the KeeLine® II is installed on to.
- Oil, Grease or any other substance has contaminated neither the roof surface nor the KeeLine® II system.
- Any Instructions issued by manufacturers of combined components have been complied with.

DANGER!



Should any doubt arise about the safety of any part of the system, do not use it and remove it from service immediately and seek advice from your Kee Line II supplier.

7.2 Swageless Wire Termination

Check the terminal regularly for damage in connection with longer exposure to concentrated saline solutions or polluted surroundings. Check the seal, if it is broken remove all sealing compound. Then rinse the terminal with fresh water and treat it with WD40. Reseal the terminal with non-acidic sealing compound.

Should any doubt arise about the safety of any part of the system, do not use it. Remove it from service immediately and seek advice from your KeeLine® II supplier.

7.3 Maintenance & Storage

KeeLine® II is manufactured from stainless steel and galvanised steel. All component and assembled parts should be kept clean, using detergent if necessary, by wiping down with a wet cloth or hosing with clean water, after which they should be wiped down with a dry cloth.

Should it ever be considered necessary to disinfect KeeLine® II, please contact the manufacturer first to check that the chosen disinfectant will not cause any damage to the equipment.

Storage should be in a dry, chemically inert environment, away from any sources of damage, and in such a way that the parts of the dismantled product(s) will not become lost or misplaced.

8 INSTRUCTIONS FOR REPAIR / REPLACEMENT

If a user suffers a fall from a height while using the KeeLine® II, or if it becomes damaged in any way, the manufacturer should be contacted and arrangements made to return it to them for inspection and any necessary repair or component replacement.

DANGER!



Do not attempt to repair KeeLine® II unless written permission has been obtained from the manufacturer or authorised representative.

9 RECORDS

It is strongly recommended that a record be kept for each KeeLine® II System. The record should contain headings for and spaces to allow entry of at least the details shown in the **example** below:

EQUIPMENT RECORD (EXAMPLE)

Name: KeeLine® II Model 1/1		Type: Horizontal line system to EN795:2102 Type C & CEN TS 16415:2012	
Name and address of Authorised Agent: Kee Safety Ltd Cradley Business Park Overend Road Cradley Heath B64 7DW		Unique identification number: ***** Year of manufacture: **** Purchase date: ***** Date first put into use: *****	
Other compatible components to be used		Other compatible components to be used	
Supporting Anchors to EN795.		Full body Harness To EN361	
connectors to EN362		Fixed Length Lanyard to EN354/ 355/ 358	
Record of use		Record of use	
*****	Inspect gutters		

PERIODICAL EXAMINATION AND REPAIR HISTORY (EXAMPLE)

Date	Reason for entry (Type of examination/repair)	Defects noted or other comments (and repairs carried out, if any)	Name (in capital letters) and signature of competent person	Next due date for periodical examination
*****	Thorough examination. (PPE)	None	A.N. OTHER A N Other	*****

10 GENERAL WARNINGS

10.1 Alterations

Make no alterations to this equipment without the manufacturers written consent. Repairs should only be carried out by the manufacturer or with their written consent.

10.2 Unintended Use

Do not use the equipment for any other purpose than that for which it is intended. If in any doubt contact the supplier or manufacturer.

10.3 Safety of Combined Components

Ensure that other components in the system are also compatible. In particular, check that the connectors used for attachment of the safety line to KeeLine® II are of a compatible design and that they will be loaded correctly, i.e. in the correct plane and at the correct locations on the connector, attachment eye and lanyard termination loop. Remember that a full body harness (e.g. conforming to EN 361 Full body harnesses) is the only acceptable body-holding device that can be used in a fall arrest system. In combining product components from different manufacturers for resale, installers or suppliers are considered to take on the role and responsibilities of a manufacturer for some purposes. Such persons should assure themselves of the compatibility of combinations, by reference to individual manufacturers or by relevant testing.

10.4 Minimise Any Free Fall Potential

It is essential for safety that the anchor point is always positioned, and the work carried out in such a way, that any free fall would be minimised. Under normal circumstances, and foreseeable conditions of use, if correctly installed, KeeLine® II will always achieve this.

10.5 Free Space Beneath the User

If the fall protection system is a fall arrest system (see), it is essential for safety to verify the free space required beneath the user at the workplace before each use. This is to ensure that, in the case of a fall, there will be no collision with the ground or other obstacle in the fall path despite the possible extension of the energy absorber.

Sufficient ground clearance, free from obstacles, must be allowed for the path of any falling body. Where appropriate, allowances should be made for any pedestrian or vehicular access in the fall zone.

10.6 Personal Issue Equipment

Kee Line is not normally intended to be an item of personal issue.

10.7 Hazards

Users should be aware of hazards that could affect the performance of KeeLine® II, and the systems used with them. For instance, erection of a system in an especially corrosive environment should encourage more frequent thorough examinations.

11 TRANSPORTATION

Kee Line® II components are of robust construction. While care should be taken during transportation not to cause any damage to them, special packaging is not required.

12 MARKINGS ON THE PRODUCTS AND THEIR MEANING

Various markings can be found on KeeLine® II components. Always check the legibility of the product markings. The meaning of these markings is as follows:

Marking	Meaning
Kee Safety Ltd	The supplier of KeeLine®II.
Horizontal Flexible Lifeline	Type of personal protective equipment.
08.02	Date & Batch Number for ease of traceability.
EN 795:2012 Type C	KeeLine® II conforms to EN 795:2012.
CEN TS 16415	KeeLine® II conforms to CEN TS 16415.
Users must read and understand the instructions for use for this product.	Users should be fully conversant with the instructions for use before using this product. Always follow the warnings and instructions for use.

KeeLine®

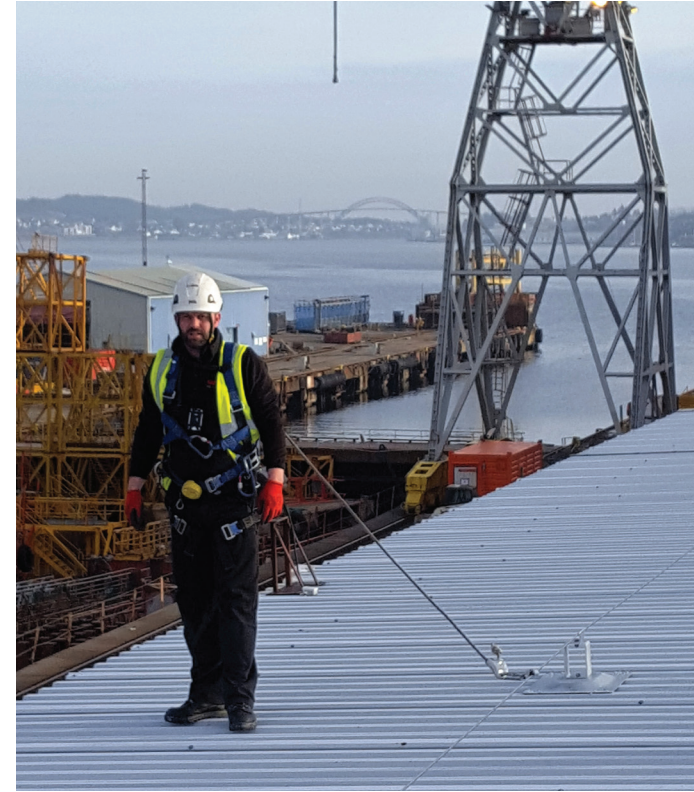

Kee Safety Singapore Pte Ltd
38 Ang Mo Kio Industrial Park 2
#01-03, Singapore 569511

Tel.: +65 6385 4166
Email: sgsales@keesafety.com
Website: keesafety.sg

KEELINE is a registered trademark of Kee Safety Ltd. Whilst every effort has been made to ensure the accuracy of the information contained within this brochure Kee Safety Ltd cannot be held responsible for any errors or omissions. Kee Safety Ltd reserves the right to alter or withdraw products without prior notice. Kee Safety Ltd accepts no responsibility for any loss or damage arising from improper use of their products. ©2018 Kee Safety Ltd. All Rights Reserved.