



SAFETY AT THE HIGHEST LEVEL

KeeGuard Ladder Kit Operation & Maintenance Manual







INTRODUCTION

KeeGuard Ladder Kit provides permanently fixed guardrail either side of an existing fixed ladder and a self-closing swing gate permitting safe roof access for the purpose of inspection or maintenance work on roofs. The kit has been specifically designed to provide a “retro-fit” solution to existing fixed ladders/cat ladders to ensure the complete assembly complies with BS EN 14122-4. The complete system has been Independently tested & CE approved to BS EN 14122-4, OSHA Reg 29, Ontario Building Code and Canadian Building Code.

APPLICATION

KeeGuard Ladder Kit has been developed to easily clamp on to the existing fixed/cat Ladder and forms a continual link from the guardrail to the stringer of the existing fixed/cat ladder. The unique fitting connecting the guardrail to the fixed/cat ladder can clamp around a flat or tubular stringer up to 75mm (3”) in width/diameter.

UNIQUE SYSTEMS

The kits design provides permanent edge protection without the need to mechanically fix the system through the roofing membrane or

building’s structure. The simple cantilever principle provides unrivalled strength, stability and safety and overcomes the problems associated with traditional systems such as having to drill and puncture the roof membrane which can lead to potential penetrative water damage and noise disturbance during installation. Similarly, high levels of insulation included within warm deck and inverted flat roof designs often mean it is virtually impossible to fix through, as with traditional systems, without causing cold bridging. This may then cause interstitial condensation to form within the flat roof construction, causing the roof to deteriorate and eventually require replacement. When it is not appropriate to use counter balanced systems, such as modern industrial cladded pitched roofs, KeeGuard Topfix may be an alternative to traditionally fixed systems.

DURABLE SYSTEMS

The Company’s guardrail and gate components are supplied with a galvanised finish carried out to BS EN ISO 1461 and ASTM A53: Hot Dip Galvanised Coatings Specification and Testing Methods, giving an average coating of between 65-85 microns. All products are also available in aluminium. All cast clamps have Threadcoat applied to all tapped holes. All grub screws are carbon steel and

have Keekoat protection applied to ensure minimal maintenance.

COMPONENT BASED SYSTEMS

All systems consist of galvanised/aluminium tubing joined together using the KEE KLAMP method of connection. KEEGUARD, raked, raked and folding systems’ base feet connect to the 100% recycled PVC counter weight, giving the system its strength & stability.

VERSATILE SYSTEMS

The systems can also cope with changes in levels, roof falls and difficult details such as ductwork passing over the roof edge and cable trays/plant mounted at the roof edge. The flexibility of the counter weight & KEE KLAMP design allows the systems to be used on plant congested or complex detailed roofs. The product range has been extended to suit specific requirements and includes the standard design with vertical and legs. Topfix has also been added to the range to provide collective protection solutions for industrial cladded roofs.



MEMBRANE PROTECTION SYSTEMS

Each system is installed with rubber matting bonded to the underside of metal components which come into contact with the roof membrane. In some cases the counter weight and base foot have sacrificial pads placed between the edge protection components and the roof membrane. This protects the roof membrane from damage via heat transfer or direct contact with components. On warm deck roof construction specifications pedestrian tiles are recommended to be placed where base feet and counter weights are in contact with the roof membrane. Where KeeGuard Topfix is installed a butyl strip is used where the Base Plates are fixed, via rivets, to the roof cladding.

TESTING & CERTIFICATION

Tested in accordance with:-

EN ISO 14122 Part 4.

BS 6399 : Part 2 Code of Practice for Wind Load.

OSHA Reg 29. Ontario Building Code and Canadian Building Code.



WIND CALCULATED

Wind loading is the most likely regular and demanding force a free standing roof guardrail will encounter during its lifetime. The Company has developed a computerised programme to calculate the design to ensure compliance with the relevant wind loadings relating to the topography, height and location of the project throughout the World.

OFFICIAL DOCUMENTATION

All Systems comply with the following:-

Work at Height Regulations.

HSG 33 "Health & Safety in Roof work"

HSE Construction Sheet No. 21 "Working on flat roofs protection against falls."

European Union Directives together with requirements of CDM Regulations.



AESTHETICS

The smooth lines of the standard galvanised/aluminium finish can be further enhanced by the application of powder coating to BS 6497 Specification for Powder Organic Coatings, EU Codes with bespoke colour produced to special order. Powder coating - USA - AAMA 2603 - 2605.

Counter weights are available in black or other colours at an additional cost.

SYSTEMS DISTRIBUTORS

All systems are available as a supply and installation service or component supply only. Products are available from The Company directly or one of its licensed distributors.

INDUSTRIAL CLADDED ROOFS

The Company has developed a new collective roof edge protection system, KeeGuard Topfix specifically for metal profile and standing seam roofs up to 45°. Pitched cladded roofs have traditionally been protected using personal fall protection systems which are lower in the hierarchy of controls.

PRODUCT SPECIFICATION – EN 14122-3-4 & NF E85-003

FEATURES:- Standard Vertical, Raked, Radiused System.
Recycled PVC Counter Weight System

GENERAL

KeeGuard® systems do not require physical fixing into the roof's structure/membrane. The complete system's design, manufacture, testing and installation has been externally assessed and tested to EN 14122-3-4 & NF E85-003

MATERIALS

Steel tubing to EN 10255 (Wall thickness 3.2mm).
All steel components galvanised to BS EN ISO 1461.
Guardrail top and intermediate rails are produced in steel - 48.3mm external diameter (Wall thickness 3.2mm).
The vertical support legs are produced in steel - 48.3mm external diameter (Wall thickness 4.0mm).
Cantilever tubes are produced in steel - 42.4mm external diameter (Wall thickness 3.2mm).
All cast clamps have Threadcoat applied to all tapped holes. All grub screws are carbon steel and have Keekoat protection applied to ensure minimal maintenance.
All cast clamps used to join the guardrail are galvanised malleable cast iron produced to BS EN 1562 : founding malleable cast iron.
All metal components in contact with the roof membrane are covered with 3mm rubber.
Counter weights are manufactured from recycled PVC.
Where tubing is cut on site zinc rich paint is applied to the cut end of the tube.

LAYOUT

Height of guardrail is set at 1100mm. All vertical supports are set at maximum 1.0m centres depending on the system.
Recycled PVC counter weights are attached to all free standing ends and appropriately counter weighted according to roof pitch and membrane. (See table) Alternatively supported by way of a ladder clamp.

TESTING

All systems have been tested to EN 14122-3-4 & NF E85-003.

WIND LOADING

All installations are wind speed calculated to Eurocode 1: Actions on structures - Part 1-4: General actions - Wind loads.



EN 14122-3-4 & NF E85-003					
Roof Type	MAX Pitch	Tube Size	Tube Thickness	End Counter	MAX End Bay Length
Mineral Grade Felt					
UnRestrained	3°	8	3.2mm	CB4	1m

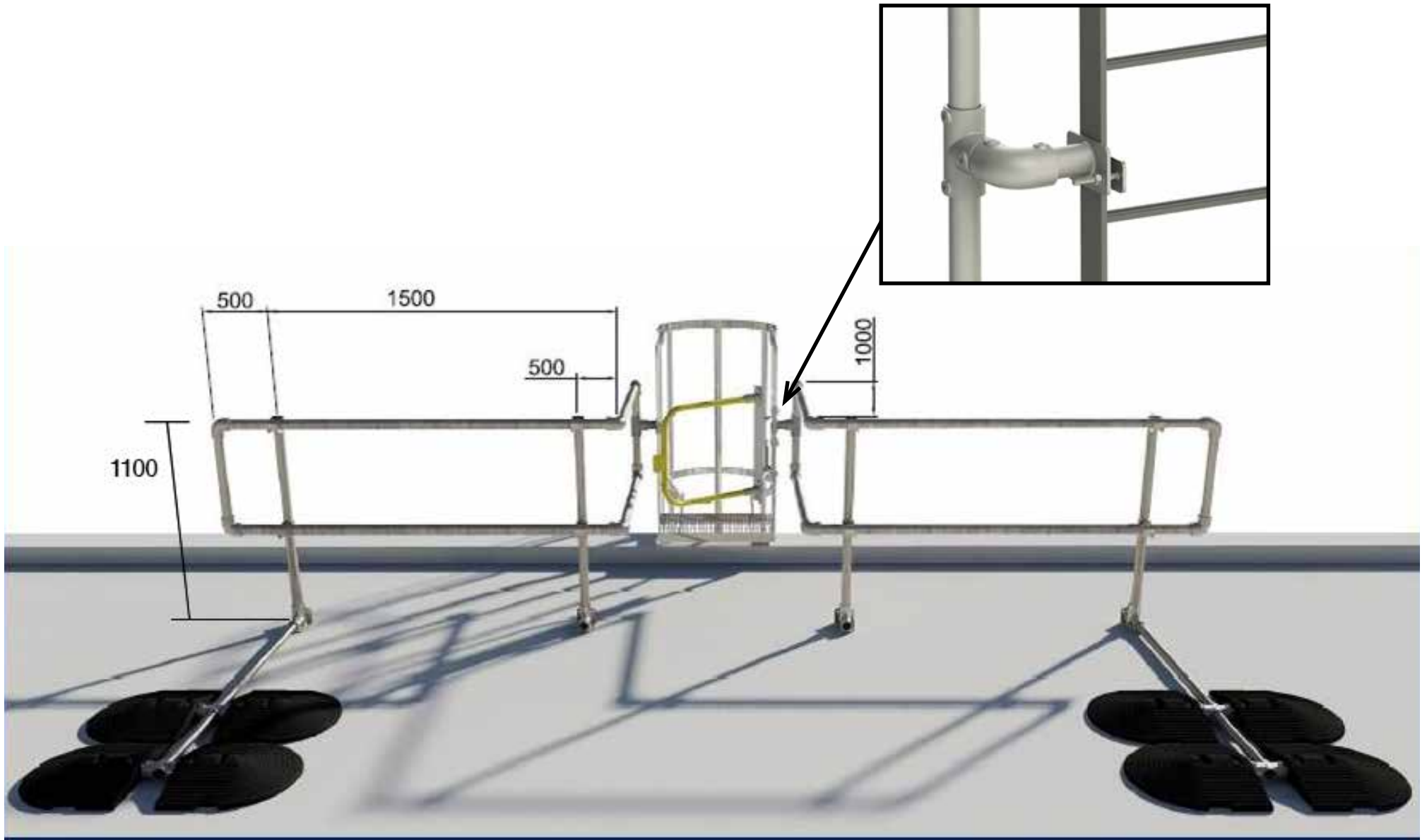



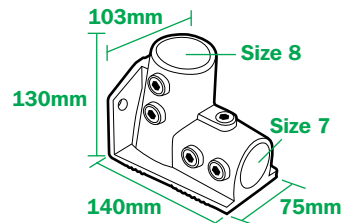

***BASE FOOT - 11308-7510 (T1308-7510-TOE-BOARD-OPTION)**

This unique component provides support to the system and allows the system to be set at 90° or raked back at 11°. The Base Foot connects the Cantilever Tubes and Counter Weights. The base is bonded with fluted rubber matting for membrane protection.

Material : Malleable cast iron to BS 1562 and galvanised to BS EN ISO 1461. Net weight : 2kg.

REPLACEMENT RUBBER PAD - K1351-4080

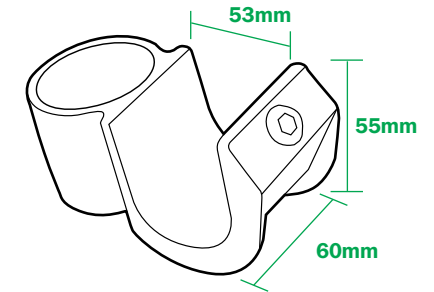

***SADDLE CLAMP - 135-8**

This open cup fitting provides the method of linking the horizontal Main Rail Tubes to the Support Legs. Material : Malleable cast iron to BS 1562 and galvanised to BS EN ISO 1461. Net weight : 0.77kg.

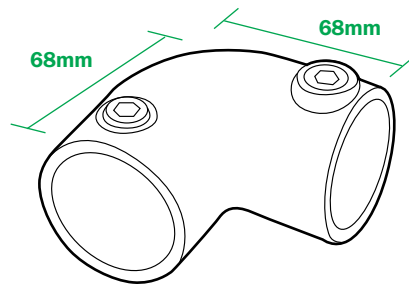

90° ELBOW - 15-8

This provides the means of dealing with corners and changes in level.

Material : Malleable cast iron to BS 1562 and galvanised to BS EN ISO 1461. Net weight : 0.76kg.

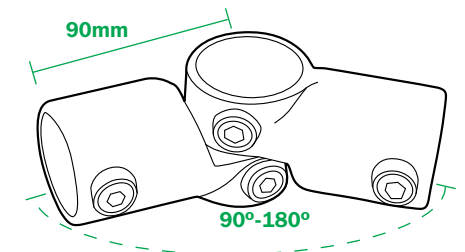

ADJUSTABLE SIDE OUTLET TEE ELBOW - 19-8

Used in pairs these components deal with angles 90°-180° and changes in level.

Material : Malleable cast iron to BS 1562 and galvanised to BS EN ISO 1461.

Net weight : 1kg.

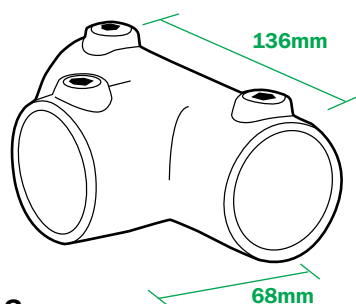

THREE SOCKET TEE CONNECTOR - 25-8

This component can be used in many different instances, for example, changes in level.

Material : Malleable cast iron to BS 1562 and galvanised to BS EN ISO 1461.

Net weight : 1.08kg.

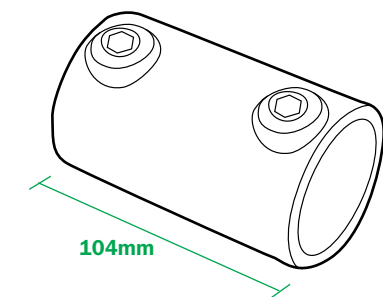

STRAIGHT COUPLING - 14-8

This component provides the method to link the horizontal Main Rail Tubes.

Material : Malleable cast iron to BS 1562 and galvanised to BS EN ISO 1461.

Net weight : 0.6kg.

*** Sold as replacement parts only**

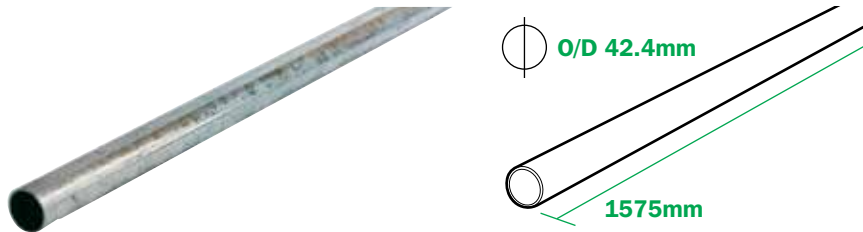

CANTILEVER TUBE - (1575mm - CBT2)

This component provides the link between the Counter Weight and Base Foot.
Material : Steel tubing to EN 10255 - 3.2mm. All steel components galvanised to BS EN ISO 1461. Cantilever tubes are produced in steel – 42.4mm external diameter. (Wall thickness 3.2mm) First/ last Cantilever tube length 1575mm Net weight : 4.48kg. Intermediate cantilever tube length 1075mm Net weight : 3.26kg.

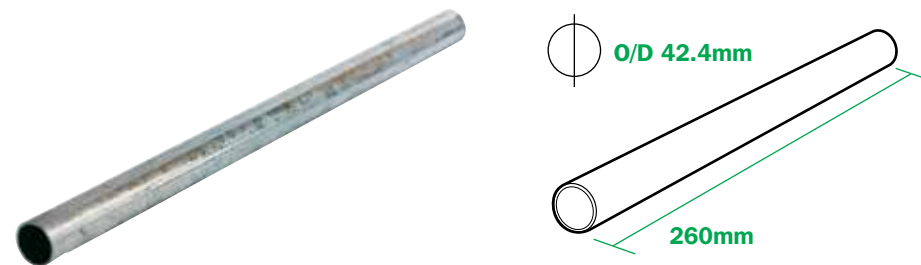

SMALL CANTILEVER TUBE/COUNTER WEIGHT LINK - CBT3

Used in pairs at the end details these components provide the link between the Counter Weights and the Cantilever Tube via the Two Socket Cross fitting. Material : Steel tubing to EN 10255 - 3.2mm. All steel components galvanised to BS EN ISO 1461. Tubes are produced in steel – 42.4mm external diameter. (Wall thickness 3.2mm) Net weight : 0.78kg.



MAIN RAIL TUBE - (2.133m - 8610213)

These components provide the horizontal rails of the system. Guardrail top and intermediate rails are produced in steel - 48.3mm external diameter.
Material : Steel tubing to EN 10255 - 3.2mm.
All steel components galvanised to BS EN ISO 1461. Net weight : 7.6kg

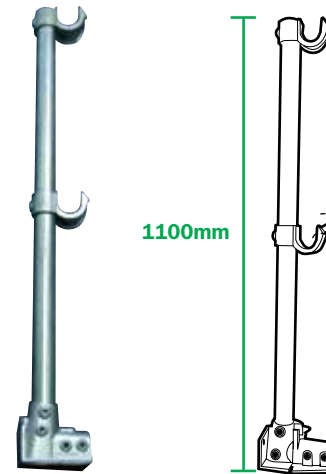

STANDARD SUPPORT LEG

These assemblies allow the guardrail to be installed in different orientations:- standard 90°. The support leg also allows for height adjustment to the system. The vertical support legs are produced in steel - 48.3mm external diameter. Material : Steel tubing to EN 10255 – 3.2mm. All steel components galvanised to BS EN ISO 1461.

EN 14122 Part C		
DESCRIPTION	Wall Thickness 3.2mm	
	Part Code	Weight kg
UPRIGHT WITHOUT TOEBOARD		
VERTICAL UPRIGHT	KGU35	8.5
UPRIGHT WITH TOEBOARD		
VERTICAL TOEBOARD UPRIGHT	KGU35T	8.8

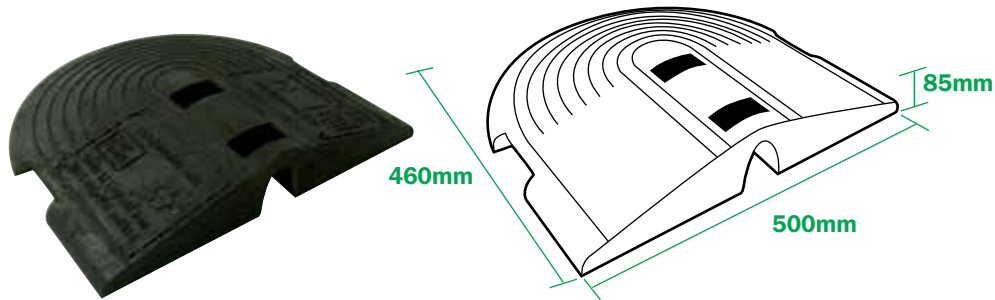

*RECYCLED PVC COUNTER WEIGHT - 440-7

This component provides the stability to the system.
Material : Recycled PVC Net weight : 13.3kg.

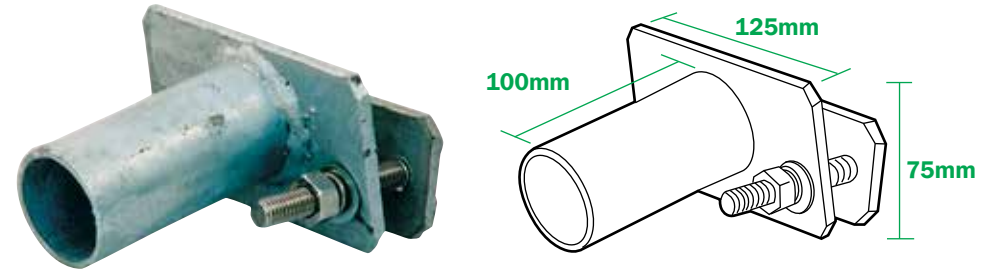

WALL/LADDER CLAMP - SL109C

This component provides the means to terminate the system against a façade or clamp the system to a cat ladder/structure where the stringer is a maximum of 70mm wide.
Material : Galvanised steel to BS EN ISO 1461. Net weight : 1.1kg.

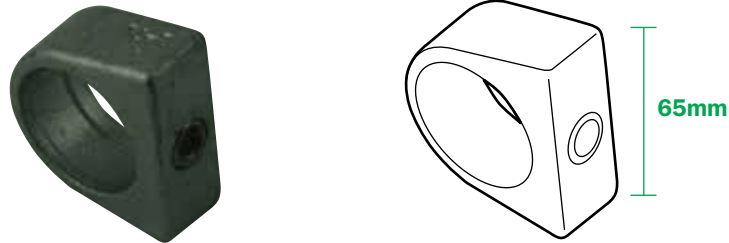

COLLAR - 74-7

This component is inserted in the first slot of the recycled PVC Counter Weight. The cantilever tube is pushed through this fitting and the grub screw is then tightened. This component provides the connection between the Cantilever Tube and the Counter Weight.
Material : Malleable cast iron to BS 1562 and galvanised to BS EN ISO 1461. Net weight : 0.24kg.

Keep Safety **CANTILEVERED ROOF EDGE PROTECTION**
SEPARATING PEOPLE FROM HAZARDS

HEAD OFFICE
Kee Safety Limited
Cradley Business Park
Overend Road
Cradley Heath
West Midlands B64 7DW

(t) +44 (0) 1384 632 188
(f) +44 (0) 1384 632 192
(e) info@keesafety.co.uk
(w) www.keesafety.co.uk

- THIS GUARDRAIL IS TESTED TO EN 13874/EN 14122-3
- DO NOT REMOVE, TAMPER, ADJUST, REMOVE OR ALTER IN ANY WAY THE GUARDRAIL INSTALLATION WITHOUT FIRST CONSULTING KEE SAFETY.
- NO LANYARD LIFE LINE OR FALL ARREST PRODUCTS TO BE ATTACHED TO THE GUARDRAIL AT ANY TIME.
- DO NOT ATTACH PLASTIC SHEETING OR ANYTHING THAT WOULD INCREASE THE WIND LOADING ON THE GUARDRAIL.
- IF YOU FIND THE GUARDRAIL HAS BEEN ALTERED OR DAMAGED WITH, CONTACT KEE SAFETY IMMEDIATELY.

• RE-TEST ONLY TO BE CARRIED OUT BY AUTHORISED SERVICE AGENT.

SYSTEM PLAQUE - SL 111

Provides details of the system and approvals. Material : Plastic. Net weight : 0.085kg.

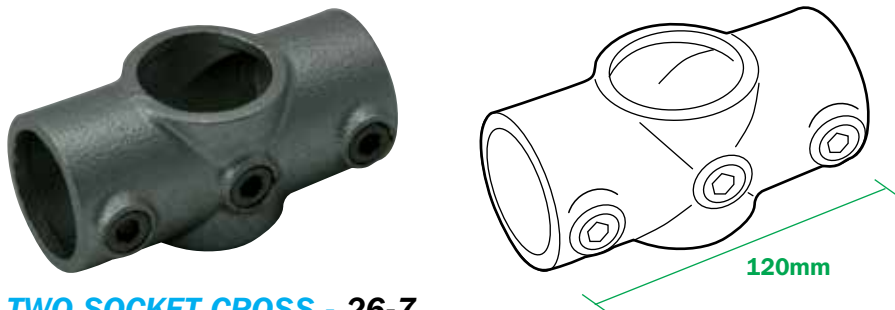

TWO SOCKET CROSS - 26-7

This component is used where two recycled PVC Counter Weights need to be joined together to form a counter weight end detail. Material : Malleable cast iron to BS 1562 and galvanised to BS EN ISO 1461. Net weight : 0.63kg.



PLASTIC CAP - SL105

This component is fitted to the top of the Support Leg to prevent water ingress.
Material : PVC. Net weight : 0.009kg.

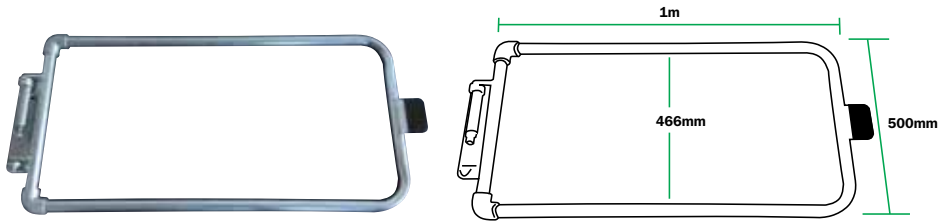

European Gate - Galvanised - SGEU500GV

Spring Loaded, self-closing safety gate. Manufactured from steel to EN 10255. 33.7mm diameter tube x 3.2mm wall thickness to meet requirements of EN 13374 & EN 14122. Complete with fixing pack.

Material : Galvanised steel to BS EN ISO 1461. Net weight : 11kg (24lb 4oz).

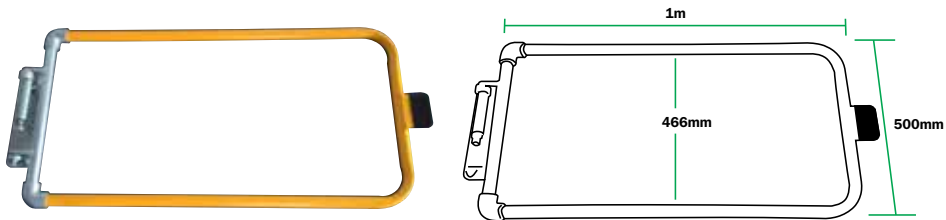

European Gate – Powder Coated - SGEU500PC

Spring Loaded, self-closing safety gate. Manufactured from steel to EN 10255 33.7mm diameter tube x 3.2mm wall thickness to meet requirements of EN 13374 & EN 14122. Complete with fixing pack. Powder Coated Finish to EN 13438.

Material : Steel to EN 10255. Net weight : 11kg (24lb 4oz).



SAFETY GATE EUROPEAN FIXING PACK 1 - SGEUFXP1

Supplied for the European market to fit posts 33.7mm, 42.4mm and 48.3 mm diameter. Fixing pack contains 3No U Bolts for each size complete with M8 and M10 nuts and washers.

Material : Galvanised steel to BS EN ISO 1461. Net weight : 0.864kg (1lb 14oz).







PRODUCT SPECIFICATION – USA & Canada

FEATURES:- Standard Vertical, Raked, Radiused System.
Recycled PVC Counter Weight System.

GENERAL

KeeGuard® systems do not require physical fixing into the roof's structure/membrane. The complete system's design, manufacture, testing and installation has been externally assessed.

TESTING

All systems have been tested to:-
 OSHA Reg 29 CFR 1910.23 (E) (1); (E) (3) (IV).
 OSHA Reg 29 CFR 1926.501 (b) (1); (b) (2) (ii)
 OSHA Reg 29 CFR 1926.502 (B) (1) - (B) (14)
 Canadian National Building Code 4.1.10.1(1)(e), 4.1.10.1(2), 4.1.10.1(4)
 Ontario Building Code Section 4.1.10.1(1)(b), 4.1.10.1(2), 4.1.10.1(4)

MATERIALS

Gatorshield Tubing
 Base Metal: ASTM A-500 Carbon Steel.
 Zinc Spelter - ASTM B-6 High Grade Special High Grade Zinc.
 Chemical Composition - ASTM A-500.
 Material Testing - ASTM-500 and ASTM E-8.
 Guardrail top and intermediate rails are produced in steel - 1.9" external diameter (Wall thickness 0.109").
 The vertical support legs are produced in steel - 1.9" external diameter (Wall thickness 0.109").
 Cantilever tubes are produced in steel - 1.66" external diameter (Wall thickness 0.109").
 All cast clamps have Threadcoat applied to all tapped holes. All grub screws are carbon steel and have Keekoat protection applied to ensure minimal maintenance.
 All cast clamps used to join the guardrail are galvanised malleable cast iron produced to ASTM A47-77-32510.
 All metal components in contact with the roof membrane are covered with 0.118" rubber.
 Counter weights are manufactured from recycled PVC.
 Where tubing is cut on site zinc rich paint is applied to the cut end of the tube.

LAYOUT

Height of guardrail is set at 42". All vertical supports are set at maximum 6'6" centres depending on the system.
 Recycled PVC counter weights are attached to all free standing ends and appropriately counter weighted according to roof pitch and membrane. (See table) Alternatively supported by way of a ladder clamp.

WIND LOADING

All installations are wind speed calculated to ASCE7 - The American Society of Civil Engineers design standard: "Minimum Design Loads for Buildings and Other Structures"



USA & CANADA					
Roof Type	Max Pitch	Tube Size	Tube Thickness (inches)	End Counter Balance No's	Max Bay Length (feet)
Mineral Grade Felt					
Unrestrained	5°	8	0.109"	CB7	8'
Unrestrained	10°	8	0.109"	CB8	6'6"
TPO-Single Ply Membrane					
Unrestrained	5°	8	0.109"	CB7	8'
Unrestrained	10°	8	0.109"	CB8	6'6"
EPDM-Single Ply Membrane					
Unrestrained	5°	8	0.109"	CB7	8'
Unrestrained	10°	8	0.109"	CB8	6'6"



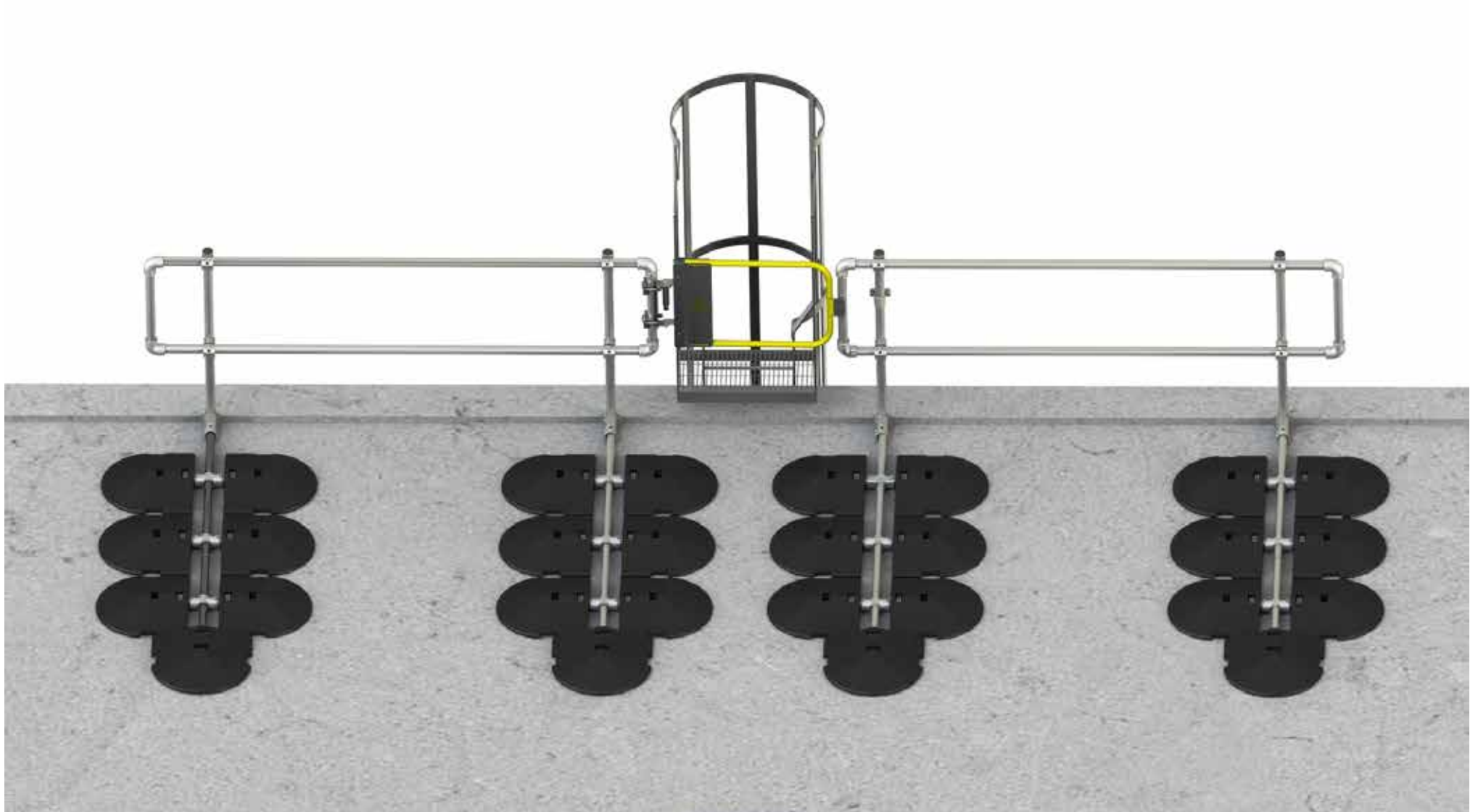

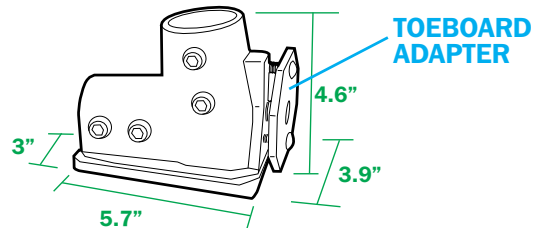

TOEBOARD ADAPTER

***BASE FOOT - 11308-7510 (T1308-7510-TOE-BOARD-OPTION)**

This unique component provides support to the system and allows the system to be set at 90° or raked back at 11°. The Base Foot connects the Cantilever Tubes and Counter Weights. The base is bonded with fluted rubber matting for membrane protection.

Material : Malleable cast iron to ASTM A47-77-32510 and galvanised to ASTM 153 Net weight : 4lb 3oz.

REPLACEMENT RUBBER PAD - K1351-4080

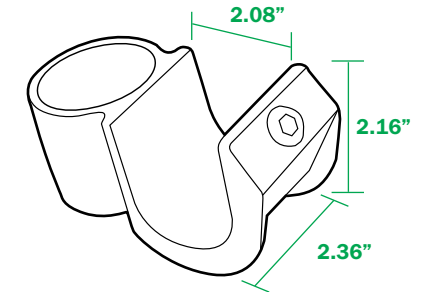

***SADDLE CLAMP - 135-8**

This open cup fitting provides the method of linking the horizontal Main Rail Tubes to the Support Legs. Material : Malleable cast iron to ASTM A47-77-32510 and galvanised to ASTM 153. Net weight : 1lb 11oz.

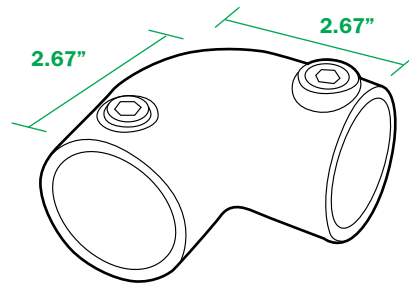

90° ELBOW - 15-8

This provides the means of dealing with corners and changes in level.

Material : Malleable cast iron to ASTM A47-77-32510 and galvanised to ASTM 153.

Net weight : 1lb 11oz.

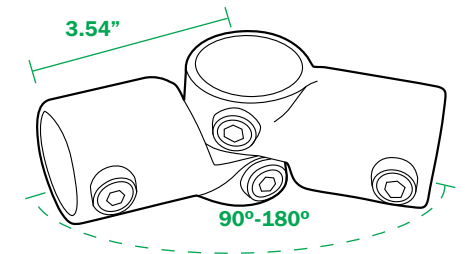

ADJUSTABLE SIDE OUTLET TEE ELBOW - 19-8

Used in pairs these components deal with angles 90°-180° and changes in level.

Material : Malleable cast iron to ASTM A47-77-32510 and galvanised to ASTM 153.

Net weight : 2lb 3oz.

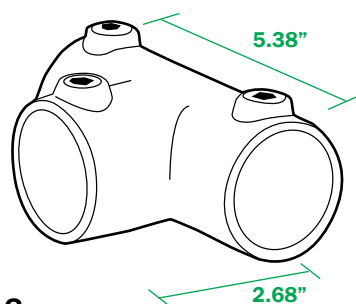

THREE SOCKET TEE CONNECTOR - 25-8

This component can be used in many different instances, for example, changes in level.

Material : Malleable cast iron to ASTM A47-77-32510 and galvanised to ASTM 153.

Net weight : 2lb 6oz.

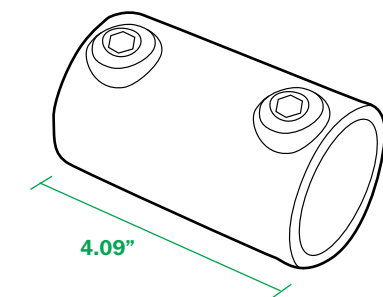

STRAIGHT COUPLING - 14-8

This component provides the method to link the horizontal Main Rail Tubes.

Material : Malleable cast iron to ASTM A47-77-32510 and galvanised to ASTM 153.

Net weight : 1lb 5oz.

*** Sold as replacement parts only**

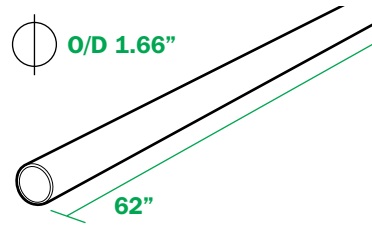

CANTILEVER TUBE - (62" - CBT2)

This component provides the link between the Counter Weight and Base Foot.
Material : Gatorshield ASTM A-500 Carbon Steel. Zinc Spelter - ASTM B-6 High Grade Special High Grade Zinc. Cantilever tubes are produced in steel – 1.66" external diameter. (Wall thickness 0.109") First/last Cantilever tube length 62" Net weight : 9lb 14oz Intermediate cantilever tube length 42.32" Net weight : 7lb 3oz.

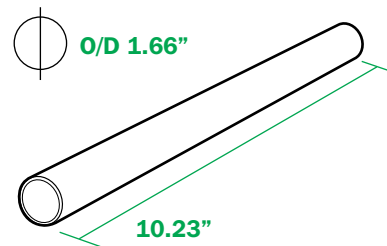
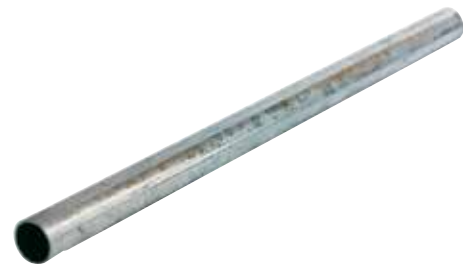

SMALL CANTILEVER TUBE/COUNTER WEIGHT LINK - CBT3

Used in pairs at the end details these components provide the link between the Counter Weights and the Cantilever Tube via the Two Socket Cross fitting. Material : Gatorshield ASTM A-500 Carbon Steel. Zinc Spelter - ASTM B-6 High Grade Special High Grade Zinc. Tubes are produced in steel – 1.66" external diameter. (Wall thickness 0.109") Net weight : 1lb 5oz.

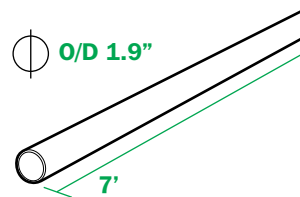

MAIN RAIL TUBE (Cut to size - G150GS12GA)

These components provide the horizontal rails of the system. Guardrail top and intermediate rails are produced in steel - 1.9" external diameter (Wall thickness 0.109").
Material : Gatorshield ASTM A-500 Carbon Steel. Zinc Spelter - ASTM B-6 High Grade Special High Grade Zinc. Net weight : 50lb 7oz, 25lb 4oz. & 16lb 12oz.

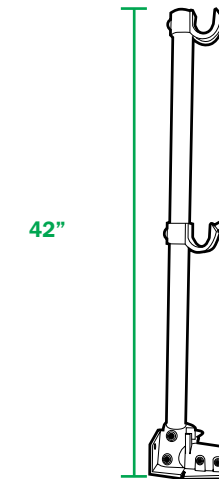

STANDARD SUPPORT LEG - KGU135

This component allows for standard 90° installation and provides some height adjustment to the system. The vertical support legs are produced in steel - 1.9" external diameter (Wall thickness 0.109"). Material : Gatorshield ASTM A-500 Carbon Steel. Zinc Spelter - ASTM B-6 High Grade Special High Grade Zinc. Net weight : 15lb 7oz.

CANTILEVERED ROOF EDGE PROTECTION
SEPARATING PEOPLE FROM HAZARDS

HEAD OFFICE
Kee Safety Limited
Cradley Business Park,
Overend Road
Cradley Heath
West Midlands B64 7DW

(t) +44 (0) 1384 632 188
(f) +44 (0) 1384 632 192
(e) info@keesafety.co.uk
(w) www.keesafety.co.uk

- THIS GUARDRAIL IS TESTED TO EN 8537/EN 14122-3
- DO NOT REMOVE, TAMPER, ADJUST, REMOVE OR ALTER IN ANY WAY THE GUARDRAIL INSTALLATION WITHOUT FIRST CONSULTING KEE SAFETY.
- NO LANYARD LIFE LINE OR FALL ARREST PRODUCTS TO BE ATTACHED TO THE GUARDRAIL AT ANY TIME
- DO NOT ATTACH PLASTIC SHEETING OR ANYTHING THAT WOULD INCREASE THE WIND LOADING ON THE GUARDRAIL.
- IF YOU FIND THE GUARDRAIL HAS BEEN ALTERED OR TAMPERED WITH, CONTACT KEE SAFETY IMMEDIATELY

• RE-TEST ONLY TO BE CARRIED OUT BY AUTHORISED SERVICE AGENT.

SYSTEM PLAQUE - SL 111

Provides details of the system and approvals. Material : Plastic. Net weight : 0.085kg.

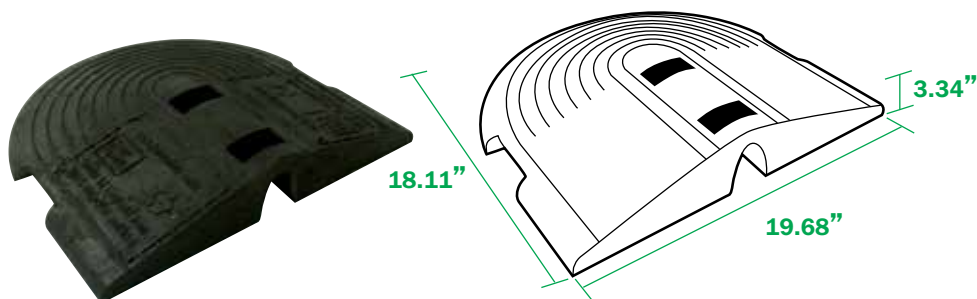

***RECYCLED PVC COUNTER WEIGHT - 440-7**

This component provides the stability to the system.
Material : Recycled PVC Net weight : 29lb 5oz.

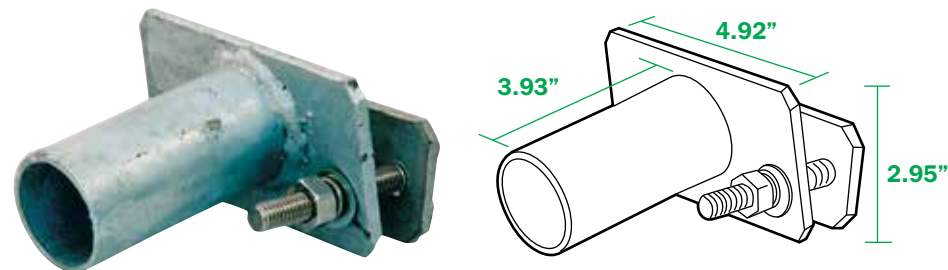

WALL/LADDER CLAMP - SL109C

This component provides the means to terminate the system against a façade or clamp the system to a cat ladder/structure where the stringer is a maximum of 2.75" wide.
Material : Galvanised steel to ASTM A53. Net weight : 2lb 7oz.

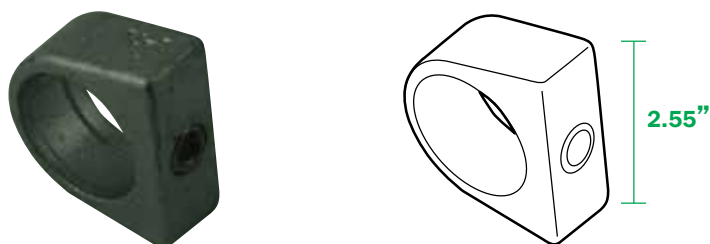

COLLAR - 74-7

This component is inserted in the first slot of the recycled PVC Counter Weight. The cantilever tube is pushed through this fitting and the grub screw is then tightened. This component provides the connection between the Cantilever Tube and the Counter Weight.
Material : Malleable cast iron to ASTM A47-77-32510 and galvanised to ASTM 153.
Net weight : 8oz.

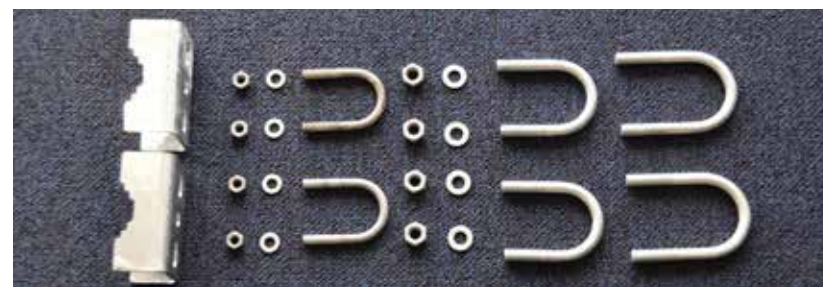

SAFETY GATE NORTH AMERICAN FIXING PACK 1 - SGNAFXPK1

Supplied for the USA market to fit posts 1.0", 1.25" and 1.5" diameter. Fixing pack contains 3No U Bolts for each size complete with 0.3125" and 0.375" nuts and washers.
Material : Galvanised steel to ASTM A53. Net weight : 1.44kg (3lb 3oz).

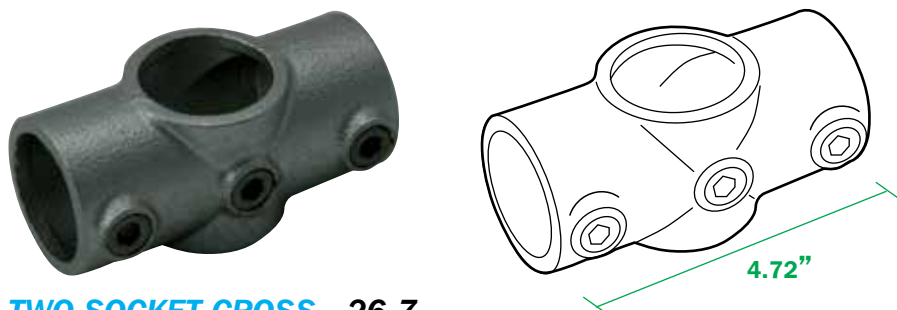

TWO SOCKET CROSS - 26-7

This component is used where two recycled PVC Counter Weights need to be joined together to form a counter weight end detail. Material : Malleable cast iron to ASTM A47-77-32510 and galvanised to ASTM 153.. Net weight : 1lb 6oz.

Kee Gate Components

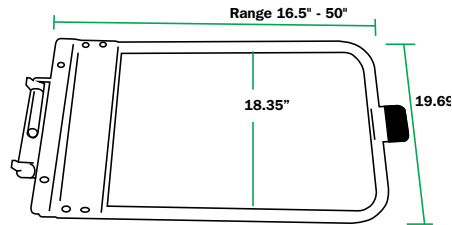

NORTH AMERICAN GATE - GALVANISED

Spring Loaded, self-closing safety gate for North America. Each model can be adjusted on site without need for cutting or welding. Complete with fixing pack.
Material : Galvanised steel to ASTM A53.

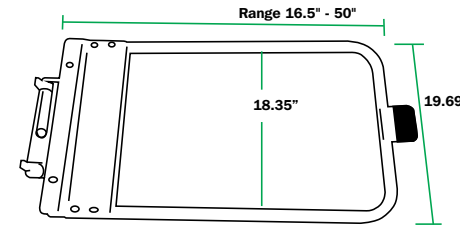
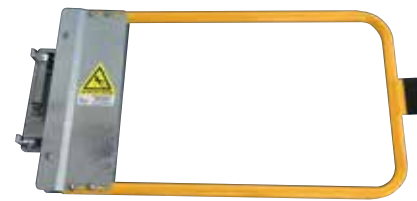

NORTH AMERICAN GATE - POWDER COATED

Spring Loaded, self-closing safety gate for North America. Each model can be adjusted on site without need for cutting or welding. Complete with fixing pack.
Powder Coated USA - AAMA 2603-2605.
Material : Galvanised steel to ASTM A53.

IMPERIAL

Single Safety Gate - Imperial					
Part No.	Description	Min (in)	Mid (in)	Max (in)	Weight (lbs)
SGNA018GV	18" Gate - Galvanised	16.5	18	20	37lbs 10oz
SGNA018PC	18" Gate - Powder Coated				
SGNA021GV	21" Gate - Galvanised	19.5	21	23	38lbs 11oz
SGNA021PC	21" Gate - Powder Coated				
SGNA024GV	24" Gate - Galvanised	22.5	24	26	38lbs 13oz
SGNA024PC	24" Gate - Powder Coated				
SGNA027GV	27" Gate - Galvanised	25.5	27	29	39lbs 15oz
SGNA027PC	27" Gate - Powder Coated				
SGNA030GV	30" Gate - Galvanised	28.5	30	32	41lbs oz
SGNA030PC	30" Gate - Powder Coated				
SGNA033GV	33" Gate - Galvanised	31.5	33	35	41lbs 3oz
SGNA033PC	33" Gate - Powder Coated				
SGNA036GV	36" Gate - Galvanised	34.5	36	38	42lbs 5oz
SGNA036PC	36" Gate - Powder Coated				
SGNA040GV	40" Gate - Galvanised	38.5	40	42	43lbs 3oz
SGNA040PC	40" Gate - Powder Coated				
SGNA048GV	48" Gate - Galvanised	46.5	48	50	44lbs 15oz
SGNA048PC	48" Gate - Powder Coated				

METRIC

Single Safety Gate - Metric					
Part No.	Description	Min (mm)	Mid (mm)	Max (mm)	Weight (kg)
SGNA018GV	18" Gate - Galvanised	418	457	508	16.8
SGNA018PC	18" Gate - Powder Coated				
SGNA021GV	21" Gate - Galvanised	494	533	584	17.2
SGNA021PC	21" Gate - Powder Coated				
SGNA024GV	24" Gate - Galvanised	570	610	660	17.5
SGNA024PC	24" Gate - Powder Coated				
SGNA027GV	27" Gate - Galvanised	647	686	737	17.9
SGNA027PC	27" Gate - Powder Coated				
SGNA030GV	30" Gate - Galvanised	723	762	813	18.3
SGNA030PC	30" Gate - Powder Coated				
SGNA033GV	33" Gate - Galvanised	799	838	889	18.6
SGNA033PC	33" Gate - Powder Coated				
SGNA036GV	36" Gate - Galvanised	875	914	965	19.0
SGNA036PC	36" Gate - Powder Coated				
SGNA040GV	40" Gate - Galvanised	977	1016	1067	19.4
SGNA040PC	40" Gate - Powder Coated				
SGNA048GV	48" Gate - Galvanised	1180	1219	1270	20.3
SGNA048PC	48" Gate - Powder Coated				

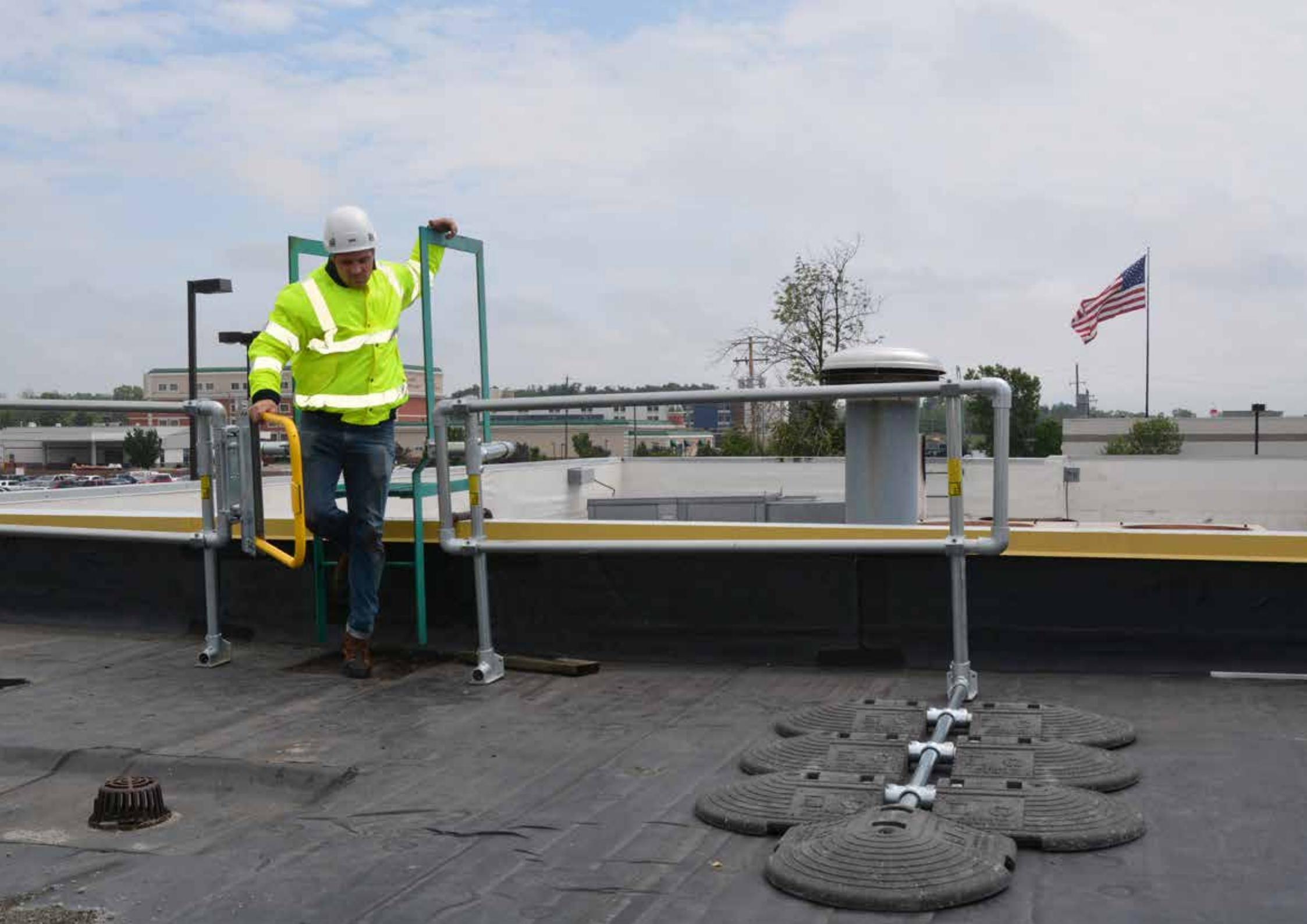

STANDARD & RAKED SUPPORT LEG (KGU32)

These are supplied already assembled at the correct height (1100mm) (42") with the Base Foot & saddle Clamps set at the correct position.



LAYING OUT SUPPORT LEG AND MAIN RAIL TUBES

Lay out the equipment in approximately the positions shown below. Always ensure that you and the equipment are at a safe distance from the roof edge. It is a recommendation of Kee Safety that this distance is no less than 2m (6'6").

Lay out two 2m (6'6") Main Rail Tubes (8610) side by side (ensure these do not roll towards the roof edge). Then start laying out the Support leg Units at a maximum of the following centres (EN 14122-3 - 1.0m centres) (OSHA Regs – 6'6" centres). Please refer to technical specification.

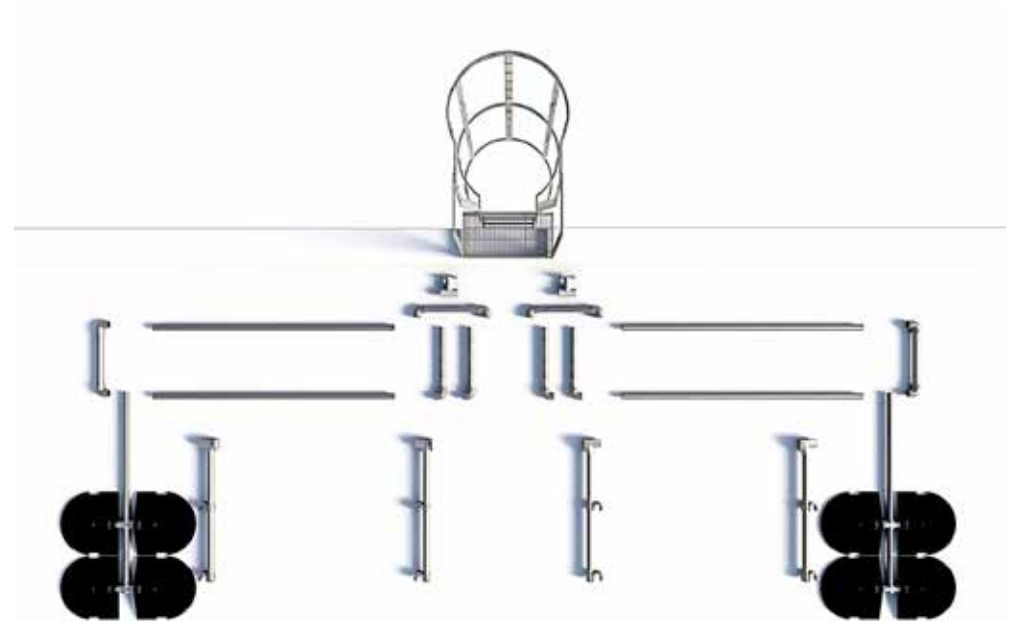

Fixed, Free Standing Details

(See tables and specifications)

FIGURE 1



A

SELF CLOSING GATE ACCESS POINT

This assumes free standing guardrail and no connection of guardrail to ladder

Extra components

- 1No. Self Closing Gate (GT25P)
- 4No. 90° Elbows (15-8)
- 2No. End pieces
- 6No. PVC Counter Weights (440-7) (EN 14122-3)
- 2No. Cantilever Tube (CBT2)
- 8No. Small Cantilever Tube Link (CBT3)
- 4No. Two Socket Cross (26-7)
- 8No. Collars (74-7)

- 14No. PVC Counter Weights (440-7) (OSHA Regs)
- 2No. Cantilever Tube (CBT2)
- 14No. Small Cantilever Tube Link (CBT3)
- 6No. Two Socket Cross (26-7)
- 14No. Collars (74-7)



B

FREE STANDING END

Extra components

- 2No. 90° Elbows (15-8)
- 1No. End piece
- 4No. PVC Counter Weights (440-7) EN 14122)
- 1No. Cantilever Tube (CBT2)
- 4No. Small cantilever Tube Link (CBT3)
- 2No. Two Socket Cross (26-7)
- 4No. Collars (74-7)

- 7No. PVC Counter Weights (440-7) OSHA Regs)
- 1No. Cantilever Tube (CBT2)
- 6No. Small cantilever Tube Link (CBT3)
- 3No. Two Socket Cross (26-7)
- 7No. Collars (74-7)



C

LADDER CLAMP

Extra components

- 2No. End piece
- 2No. Three Socket Tee Connector (25-8)
- 2No. Wall/Ladder Clamp (SL109C)
- 4No. 90° Elbows (15-8)
- 4No. Wall Fixings (SL110)
- 2No Main Rail Tubes (8610213) (2.133m)

- 2No. Main Rail Tubes - cut to size (G150GS12GA)



KeeGuard Assembly Guide

FIXED AND FREE STANDING DETAILS LAYING OUT

LAYING OUT FITTINGS, COUNTER WEIGHTS AND CANTILEVER TUBES

Where the 2No. Main Rail Tubes terminate lay out 2No. 90° Elbows at each end (15-8).
 (Use Adjustable Side Outlet Tee Elbows in pairs where corners are 90° - 180 ° (19-8)).
 See also Fixed and Free Standing Details for additional required components to connect directly to ladder or alternatively using free standing ends to terminate guardrail see below.
 (See Figure1.)

EN 14122-3

At any free standing end detail Support Leg, place 1No. Cantilever Tube (CBT2), 2No. Two Socket Cross Clamp (26-7), 4No. Small Cantilever Tubes (CBT3), 4No. PVC Counter Weights (440-7) and 4No. Collars (74-7)

OSHA Regs

At any free standing end detail Support Leg, place 1No. Cantilever Tube (CBT2), 3No. Two Socket Cross Clamp (26-7), 6No. Small Cantilever Tubes (CBT3), 7No. PVC Counter Weights (440-7) and 7No. Collars (74-7)

EN 14122-3-4 & NF E85-003					
Roof Type	MAX Pitch	Tube Size	Tube Thickness	End Counter	MAX End Bay Length
Mineral Grade Felt					
UnRestrained	3°	8	3.2mm	CB4	1m

USA & CANADA					
Roof Type	Max Pitch	Tube Size	Tube Thickness (inches)	End Counter Balance No's	Max Bay Length (feet)
Mineral Grade Felt					
Unrestrained	5°	8	0.109"	CB7	8'
Unrestrained	10°	8	0.109"	CB8	6'6"
TPO-Single Ply Membrane					
Unrestrained	5°	8	0.109"	CB7	8'
Unrestrained	10°	8	0.109"	CB8	6'6"
EPDM-Single Ply Membrane					
Unrestrained	5°	8	0.109"	CB7	8'
Unrestrained	10°	8	0.109"	CB8	6'6"

KeeGuard Assembly Guide

STAGE 1

Starting at least 2m (6'6") away from the roof edge at the corner, stand up the two Support Legs.



STAGE 2

Place a Main Rail Tube (8610) into the bottom Saddle Clamp (135-8) of each of the standing legs. Position the tube so there is at least 60mm (2-1/2") protruding from the Saddle Clamp (135-8) and tighten the Grub Screw. These are located on the front of the Saddle Clamp (135-8). Place the second Main Rail Tube (8610) into the top Saddle Clamp (135-8), positioning the tube as before, leaving at least 60mm (2-1/2") of the tube protruding from the Saddle Clamp (135-8) and tighten the Grub Screw of the Saddle Clamp (135-8).



STAGE 3

Working in pairs carefully lift the assembled bay and walk towards the leading edge. Carefully place the bay in the desired position and slide the corresponding Counter Weight tube into the Base Foot.CBT2 (Free Standing End Detail). Always ensure the bay is being held in position whilst carrying out this part of the assembly.



STAGE 4

Free Standing End Details (Refer to tables within specification page)

EN 14122-3

Slide 2No. Two Socket Cross (26-7) on to the free end of the Cantilever Tube (CBT2). Do not tighten at this stage. Slide 4No. Small Cantilever Tubes into the free ends of each of the Two Socket Cross (26-7) and tighten the grub screws holding these tubes into position. Place 1No. Collar (74-7) in the front slot of each PVC Counter Weight. Slide 1No. PVC Counter Weight on to each of the free ends of the Small Cantilever Tube (CBT3).

OSHA Regs

Slide 3No. Two Socket Cross (26-7) on to the free end of the Cantilever Tube (CBT2). Do not tighten at this stage. Slide 6No. Small Cantilever Tubes into each of the free ends of the Three Socket Cross (26-7) and tighten the grub screws holding these tubes into position. Place 1No. Collar (74-7) in the front slot of each PVC Counter Weight. Slide 1No. PVC Counter Weight on to the free end of the Cantilever Tube (CBT2). Slide 1No. PVC Counter Weight on to each of the free ends of the Small Cantilever Tube (CBT3).

Position all PVC Counter Weights as far from the Base Foot (130-875) as practically possible. Line and level guardrail. Tighten all grub screws. (See Fixed and Free Standing Details).

WARNING

Under no circumstances should any person be anchored to the system for fall arrest purposes. Further, components such as timber infill, advertising boards, polyethylene sheets must not be fixed to the system.

STAGE 5

Where it is possible to connect the ladder stringer to the guardrail use the additional components as detailed in Figure 1C to Carry out the connection.

Please see drawing below for further information:-

Note:- The guardrail spanning the parapet wall will need to be cut to the required size.

Where it is not possible to connect the guardrail to the ladder stringer please follow stage 4 and complete the fixed end detail as shown below.

(Refer to tables within specification page)

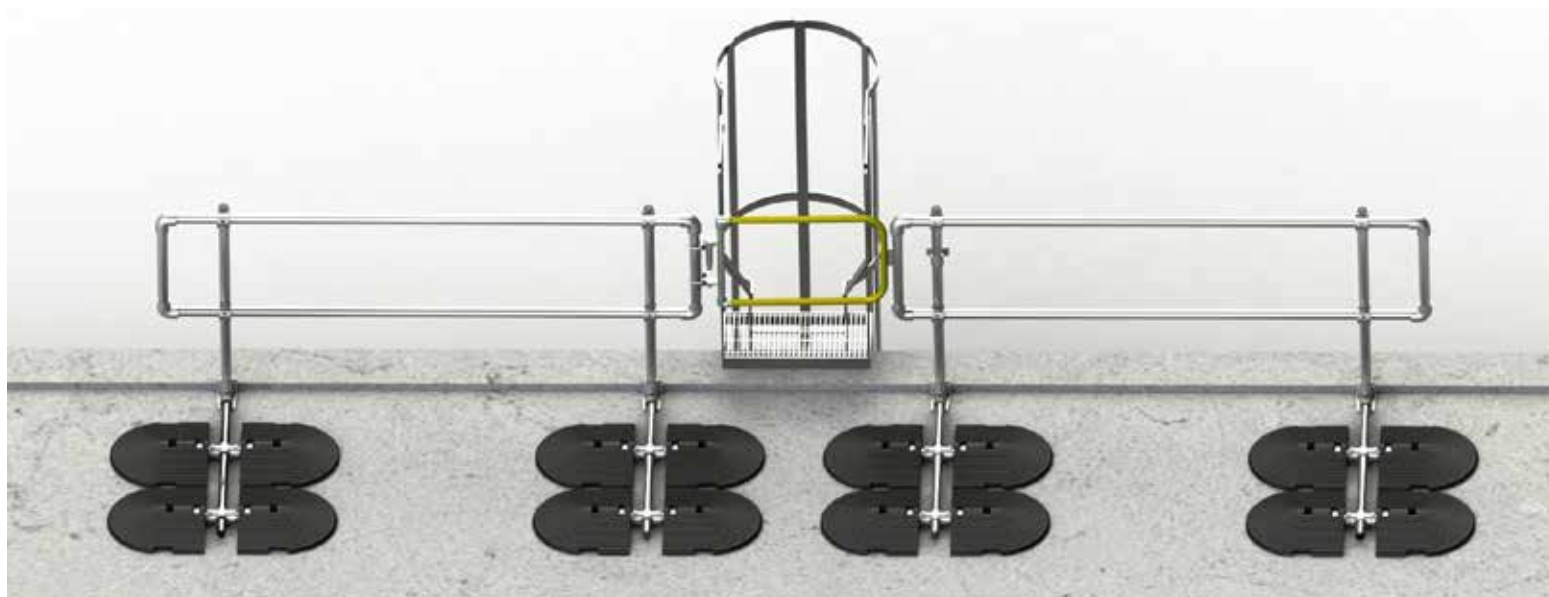

KeeGuard Layout

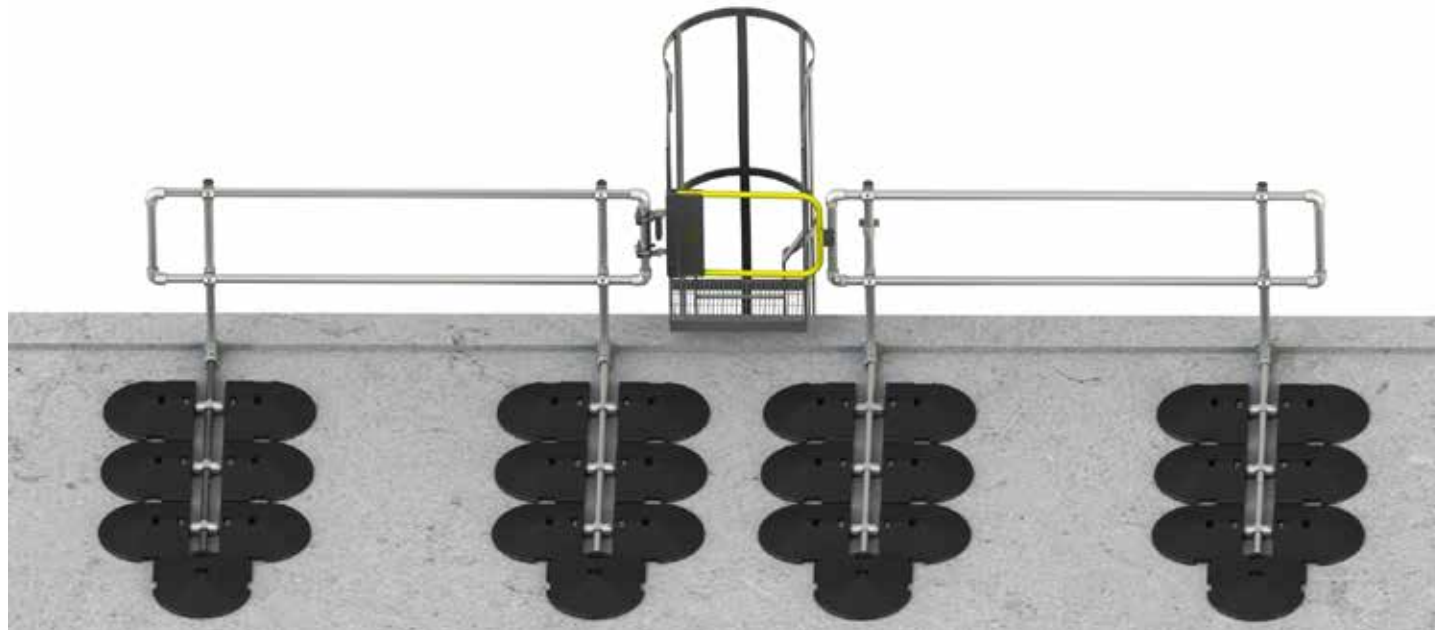
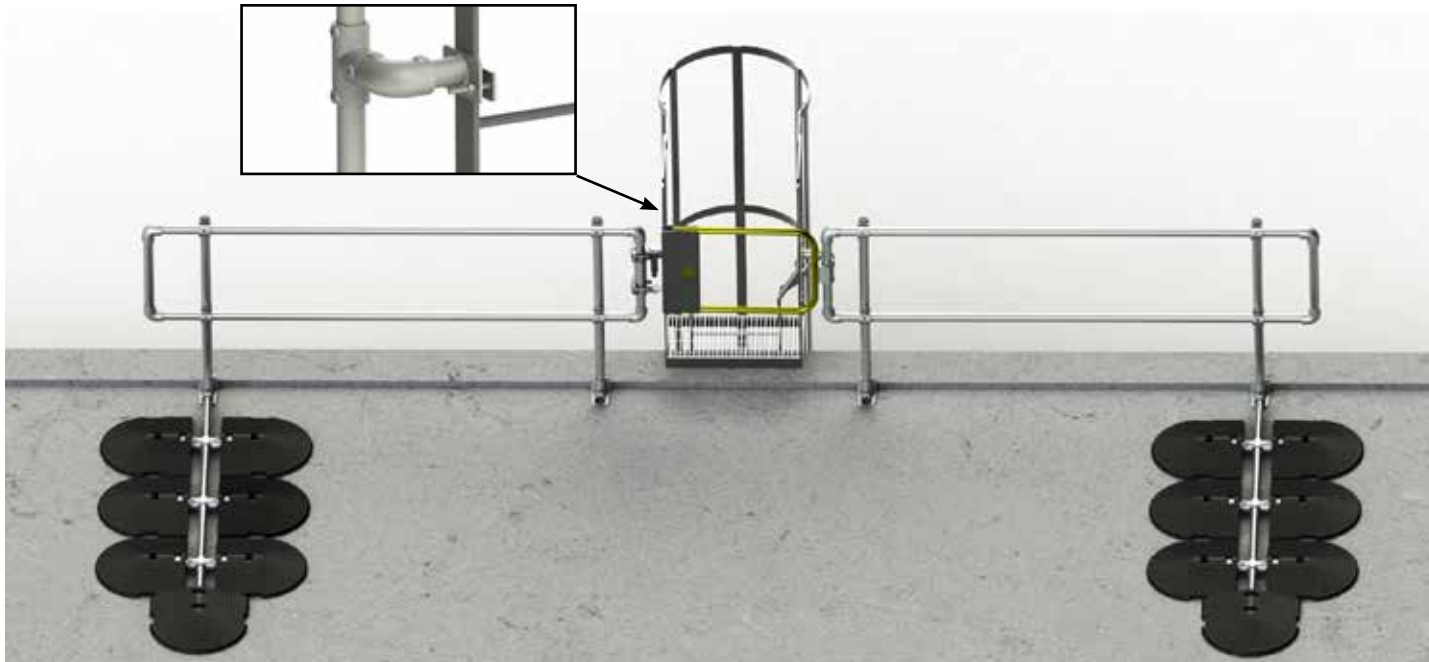

TOOLS REQUIRED

You will need the following in order to install the Kee Gate:

- Marker Pen
- Tape Measure
- 1No 24mm Ring Spanners
- 1No 13mm socket
- No 17mm socket
- 1No 24mm socket
- ¼" Hex Key Socket
- Torque Wrench 10- 60 Nm approx
- Hacksaw or Similar
- Small Magnetic Level

Mounting Gate to Upright

Establish that the gate will close in direction of hazard!!
Failure to do so could result in Death or serious injury.

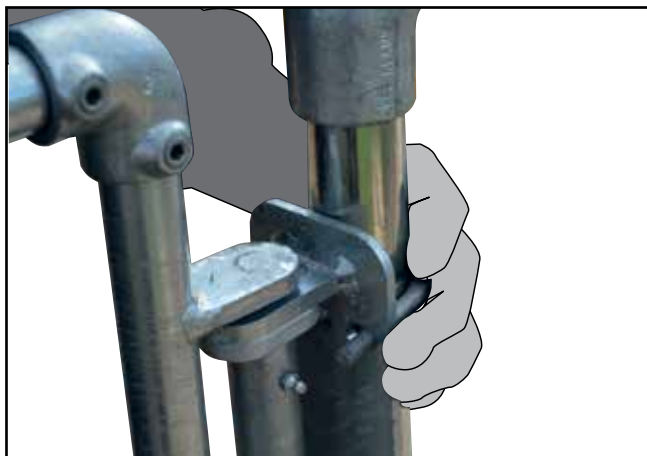

A. Align the fixing plate on internal face of the opening, so that the rails of the Safety Gate match up with the top of the Guardrail System. Select the correct U Bolt & pass around the support leg/structure and feed through the top holes of the fixing plate.

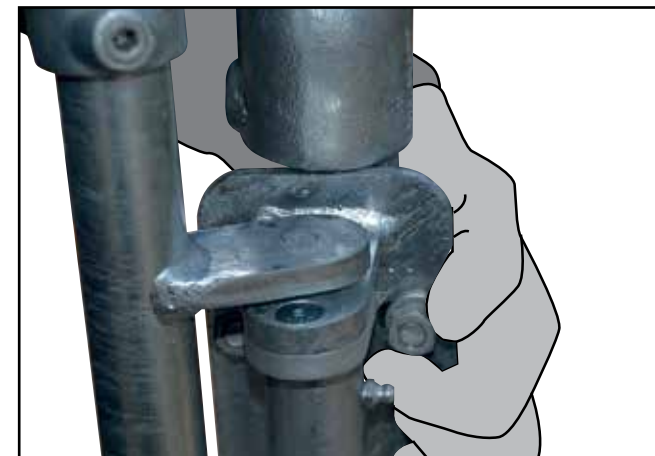

B. Using a M8 or M10 flat washer and nut connect the U bolt to the Support Leg/Structure and tighten.

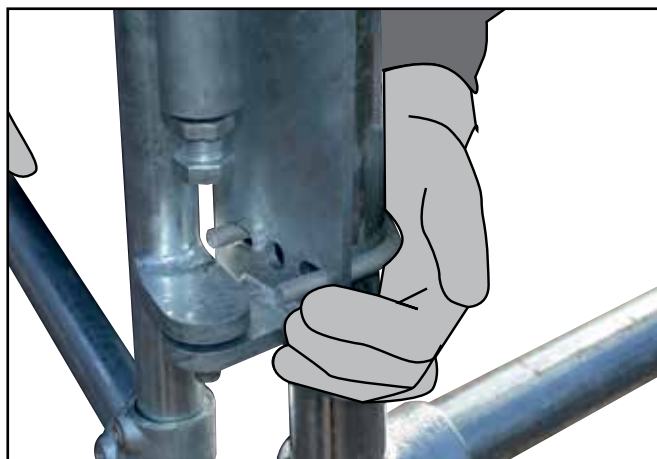

C. Pass U-Bolt around the support leg/structure and feed through the bottom holes of the fixing plate.

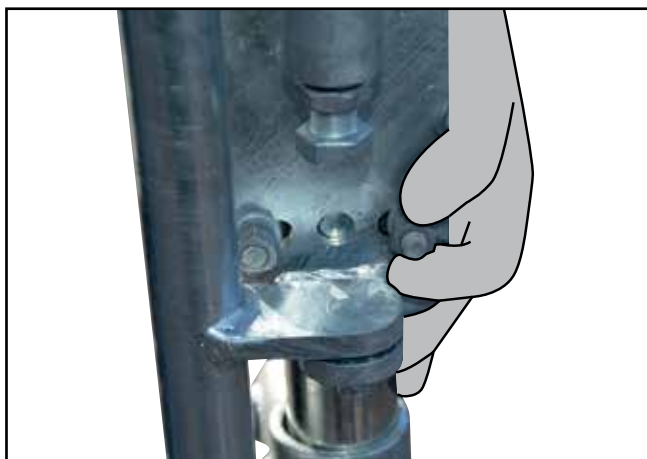

D. Using a M8 or M10 flat washer and nut connect the U bolt to the Support Leg/Structure and tighten.



E. Torque all nuts/U Bolts to 25Nm using the 13mm or 17mm socket and torque wrench.

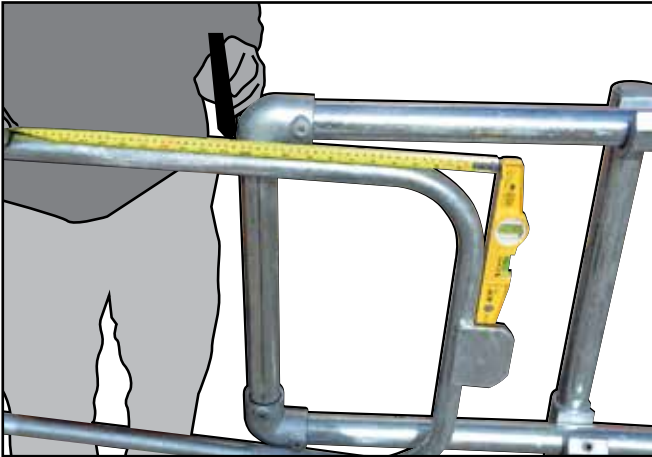

F. To cut the gate to the correct size simply place a straight edge/magnetic level as shown and measure the distance to the point where the outside edge of the vertical tube meets the supporting structure as shown. **(DO NOT CUT AT THIS MARK!)**

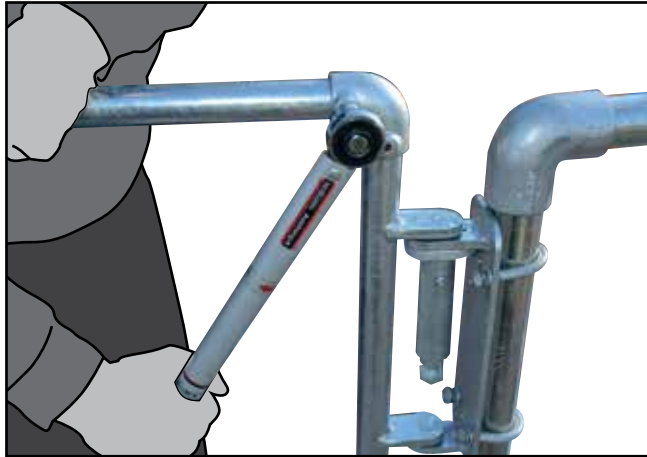

G. Disconnect the tubular gate from the hinge assembly by loosening the top & bottom cast clamp grub screw using a hex head socket as shown.

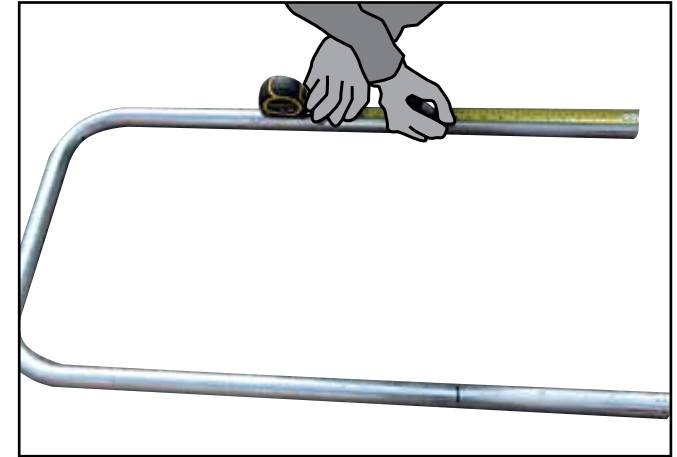

H. Measure the distance recorded in point (f) above and mark the gate top and bottom tubes as shown.

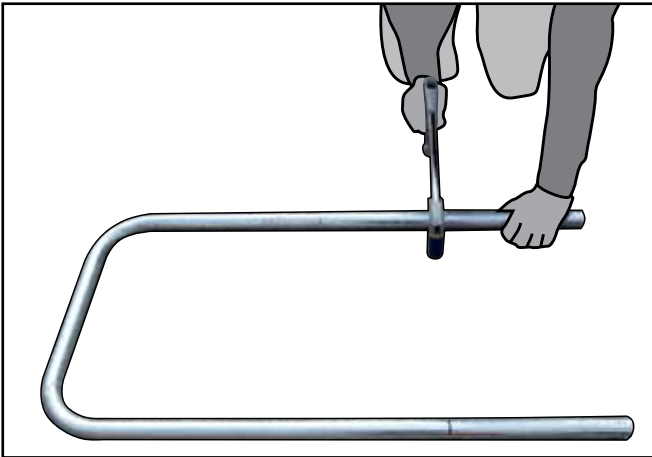

I. Using a hacksaw or similar carefully cut through the top and bottom tubes as shown. For galvanised assemblies, spray with Galvafoid or similar to prevent corrosion.

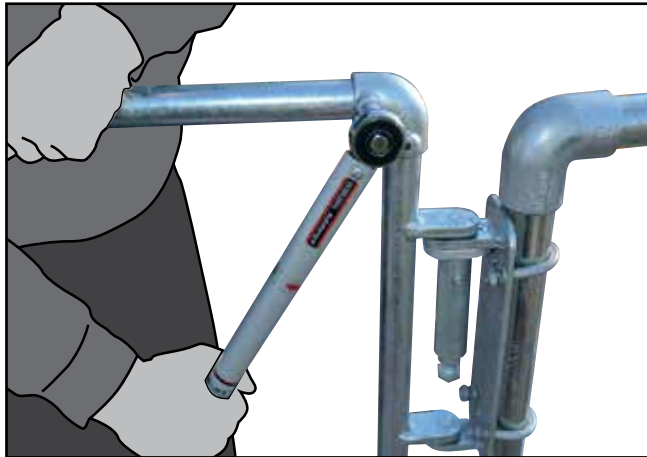

J. Carefully re-position the gate top and bottom tubes into the cast fittings. Ensure the striking plate is on the correct side of the Support Leg/Structure. Use a spirit level, to ensure the gate is level. Tighten the cast fittings grub screws using a hex head socket. Using the torque wrench ensure the castings are torqued to 39Nm.

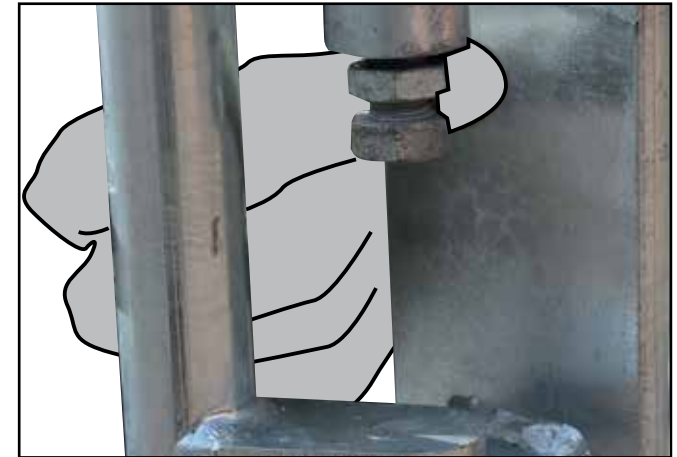

K. To tension the hinge loosen the locking nut as shown.



L. Manually open the gate at 45 degrees from its closed position.

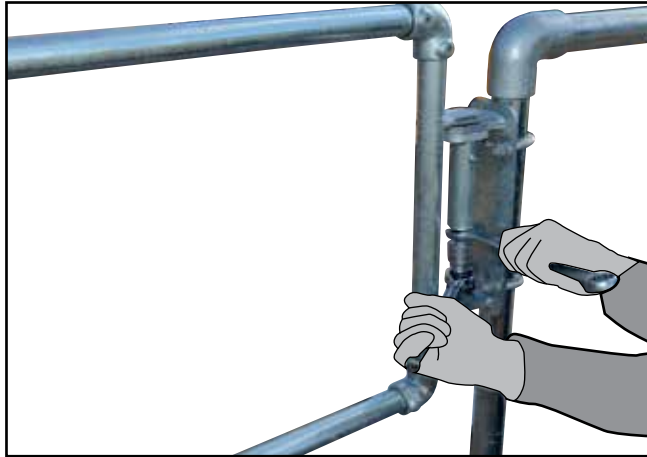

M. Using the 24mm socket & ring spanner start to tighten the bolt until the gate completely closes. (Note:- You may have to hold the socket whilst using the ratchet).

Caution! Over tensioning of the spring assembly will result in failure of the product!!

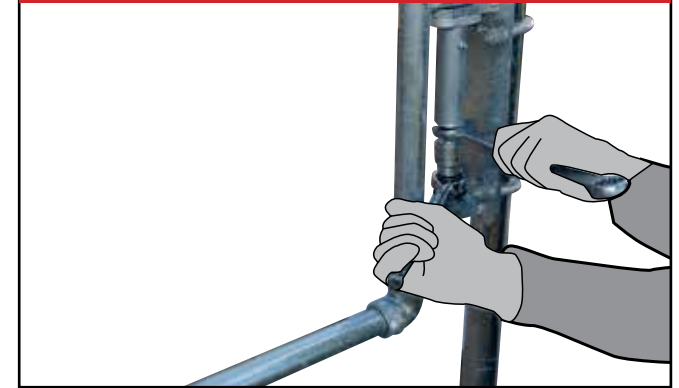

N. Once the gate is completely closed tighten the locking nut to hold the tension. Caution:- Continue to hold the ratchet firmly and do not release until the lock nut is tightened. Now remove the socket and spanner from the hinge. Repeat as necessary, to ensure that the gate closes sufficiently, once opened and released.



Note:- Installing Kee Gate

When installing Kee Gate on a pitched roof it is essential that the gate is mounted vertically level to the horizontal. This can be accommodated by using standard 90 degree Elbows (15-8) (4No required per gate).

The elbows permit adjustment allowing the Kee Gate to be orientated to the correct angle. If the gate is not set at the correct angle the hinge cannot be tensioned correctly and the gate may not close as required.



TOOLS REQUIRED

You will need the following in order to install the Kee Gate:

- Marker Pen
- Tape Measure
- 1 No 15/16" Ring Spanners
- 3/16" Allen Key
- 1 No 1/2" socket
- No 11/16" socket
- 1 No 15/16" socket
- Torque Wrench 10- 60 Nm approx
- Small Magnetic Level

Mounting Gate to Upright

Establish that the gate will close in direction of hazard!!
Failure to do so could result in Death or serious injury.



A. Align the fixing plate on internal face of the opening, so that the rails of the Safety Gate match up with the top of the Guardrail System. Select the correct U Bolt & pass it through the Steel Safety Clamp & around the support leg/structure and feed through the top holes of the fixing plate.

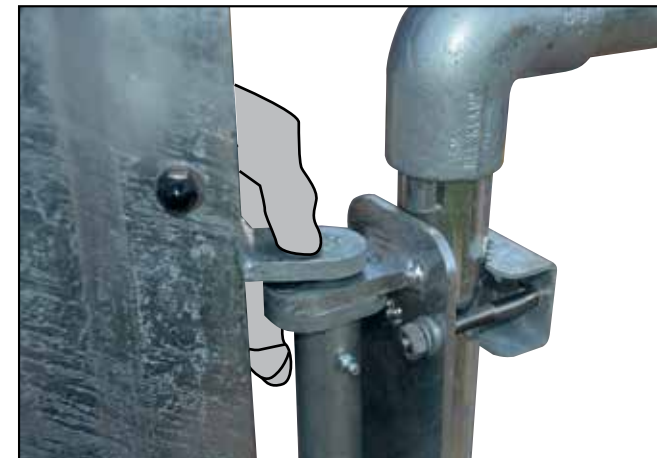

B. Using a 11/16" or 1/2" flat washer and nut connect the U bolt to the Support Leg/Structure and tighten.

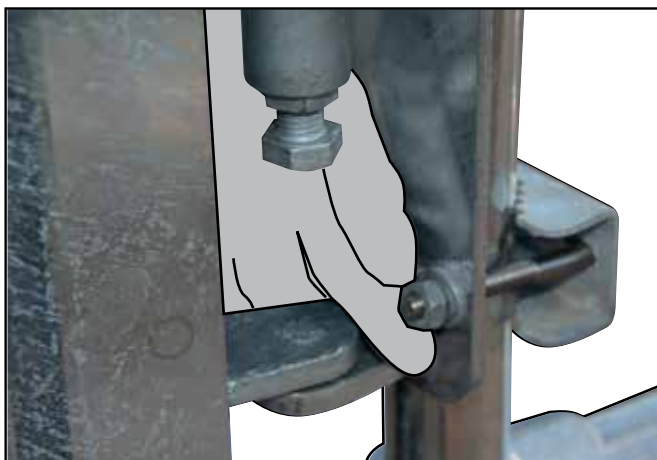

C. Select the correct U Bolt & pass it through the Steel Safety Clamp & around the support leg/structure and feed through the top holes of the fixing plate. Using a 1/2" or 11/16" flat washer and nut connect the U bolt to the Support Leg/Structure and tighten.



D. Torque all nuts/U Bolts to 25Nm using the 11/16" or 1/2" socket and torque wrench.

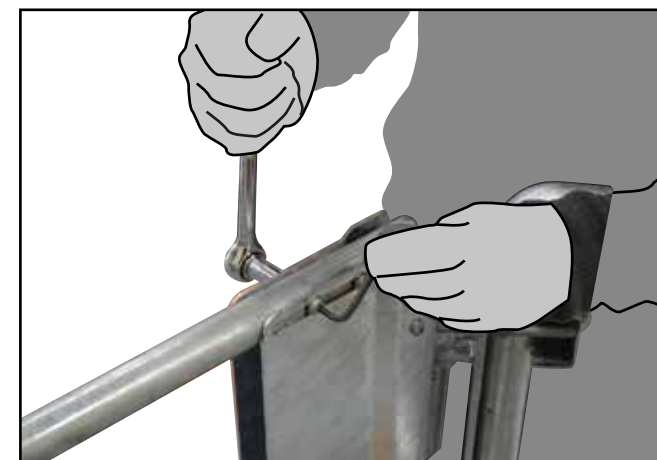

E. To extend the gates width to the required opening simply loosen the hex nuts and bolts on the top guardrail using a 3/16" Allen Key and 1/2" socket.

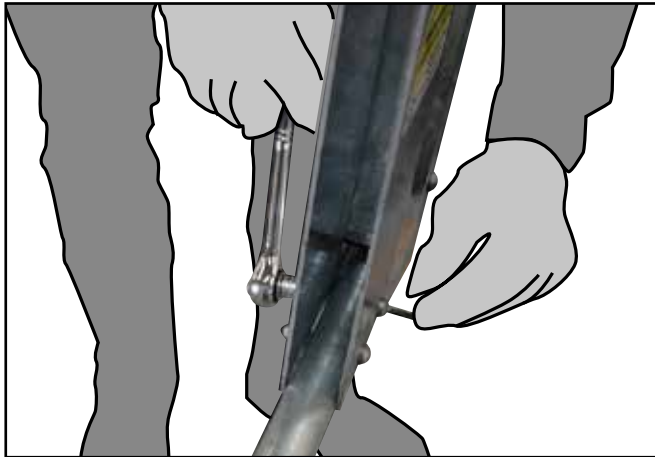

F. To extend the gates width to the required opening simply loosen the hex nuts and bolts on the bottom guardrail using a 3/16" Allen Key and 1/2" socket.

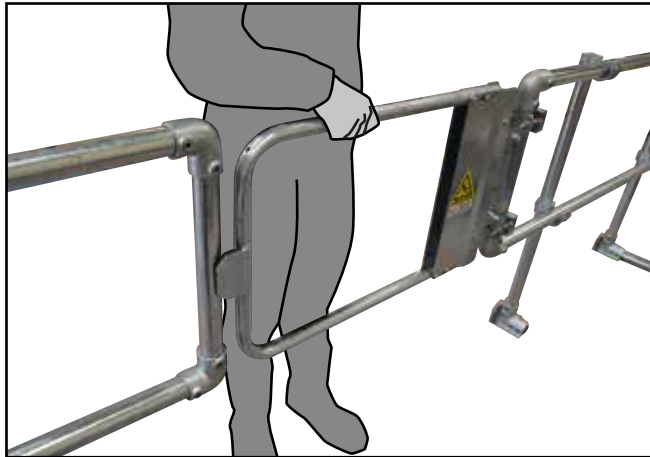

G. Establish the additional distance required so the striking plate strikes the required post.



H. Extend the gate by pulling to the required distance.

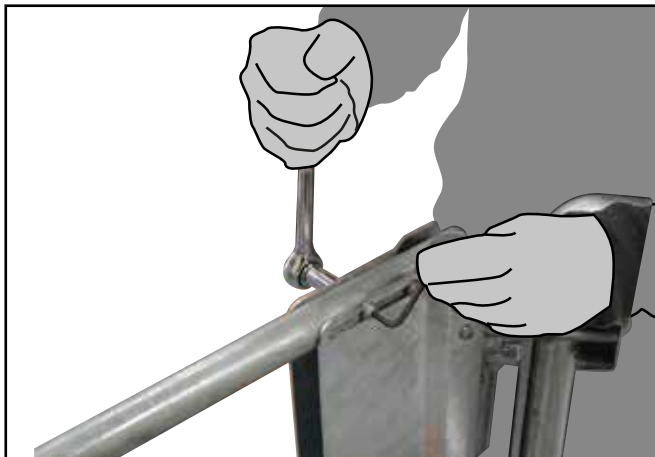

I. Once the gate is lined and levelled tighten the hex nuts and bolts on the top & bottom guardrails using a 3/16" Allen Key and 1/2" socket.

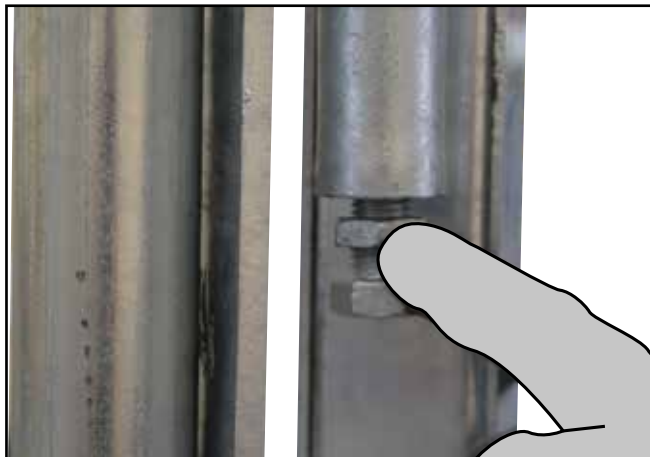

J. To tension the hinge loosen the locking nut as shown.

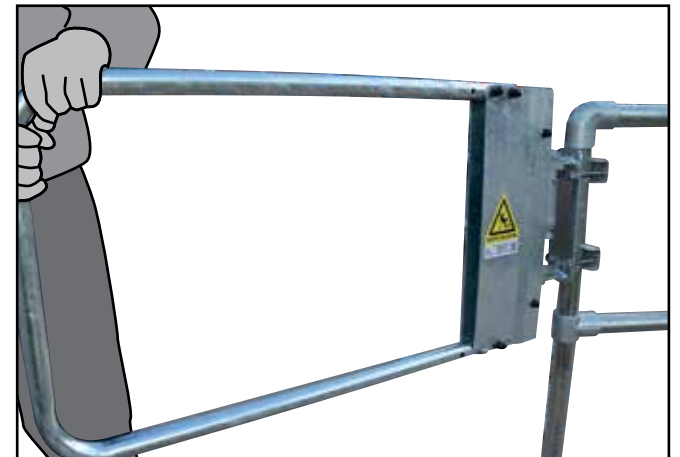

K. Manually open the gate at 45 degrees from its closed position.



L. Using the 15/16" socket & ring spanner start to tighten the bolt until the gate completely closes. (Note:- You may have to hold the socket whilst using the ratchet).

Caution! Over tensioning of the spring assembly will result in failure of the product!!



M. Once the gate is completely closed tighten the locking nut to hold the tension. Caution:- Continue to hold the ratchet firmly and do not release until the lock nut is tightened. Now remove the socket and spanner from the hinge. Repeat as necessary, to ensure that the gate closes sufficiently, once opened and released.



Note:- Installing Kee Gate

When installing Kee Gate on a pitched roof it is essential that the gate is mounted vertically level to the horizontal. This can be accommodated by using standard 90 degree Elbows (15-8) (4No required per gate). The elbows permit adjustment allowing the Kee Gate to be orientated to the correct angle. If the gate is not set at the correct angle the hinge cannot be tensioned correctly and the gate may not close as required.

Kee Gate and KeeGuard Recertification

Periodic inspections by a competent person are recommended by the manufacturer. In UK/Europe these are required under Regulation 5 of the Workplace (Health, Safety & Welfare) Regulations, the Work at Height Regulations and Provision and Use of Work Equipment Regulations.

The frequency will depend upon the environment, location and usage but should be at least every 12 months.

- Walk and visually inspect the complete installed product in relation to the general client's needs. Establish if any modifications and/or additional products are required to reflect any refurbishment requirements or additional plant & equipment which have been installed and require access.
- Check installation configuration is complete as per the original installation drawing/plan.
- Ensure the product has not been modified or tampered with by unauthorised persons.
- Check the functionality of the product.
- Check the spring is correctly tensioned.
- Check all fixings are in place, greased and sufficiently torque.
- Check the general height and level of the product.
- Any galvanised components showing signs of corrosion should be wire brushed thoroughly and galvanised spray/paint applied as appropriate. If rusted significantly, take digital photographs and include these in the inspection report.
- Inspect aluminium/stainless steel and powder coated product surfaces and note any imperfections or general degradation.
- Check fixings to walls/structures including cat ladder clamps are in place, greased and sufficiently torqued.
- Check system plaque position & mark up to reflect date of the next required inspection. Establish if additional plaques are required due to any refurbishment works.



Kee Safety Limited
Cradley Business Park
Overend Road, Cradley Heath
West Midlands, B64 7DW

Tel.: 01384 632 188
Email: sales@keesafety.com
Website: keesafety.co.uk