



SAFETY AT THE HIGHEST LEVEL

# KeeLine Operation & Maintenance Manual





# KeeLine Horizontal Life Line



## INTRODUCTION

KeeLine® Systems are the perfect answer to providing fall arrest/restraint protection where guardrails are not suitable or for when planning considerations dictate the need for a virtually invisible solution. The Horizontal Life Line provides complete and continual “handsfree” protection for up to three operatives when used as a fall arrest system. When a bracket is encountered, the traveller connecting the operative to the system, glides over the bracket without the need to detach from the fall protection system. The system can be installed to any steel cladding panel, beam/column structure, solid parapet walls and flat roofs via a support post.

## APPLICATION

Standard fixings permit the Horizontal Life Line to be fitted to standard roof types including membrane, standing seam, metal profile and composite panel roofs.

The Horizontal Life Line system incorporates PAS (Progressive Absorbing System), making the system’s design totally unique. The shock absorbers, intermediate brackets and support posts are designed to deploy and deform should an operative fall, thus reducing the loadings applied to the building’s structure to below 10kN (2248lb/ft)

## DESIGN SPECIFICATION

The KeeLine® system’s innovative design means it can span up to 12m (39’) between supports and, when installed as an overhead system, spans of up to 24m (78’) can be achieved on 8mm (5/16 or 0.31”) stainless steel cable. The system is also unique as the traveller suits multiple connectors and has been designed to allow entry/exit at any point along the entire length of the system. This traveller has been engineered with a double action fail safe mechanism and has no mechanical/moving parts which reduces the potential for misuse and maintenance requirements of the system.

Swaging at each corner has been avoided through the application of a hollow stainless steel tube which allows the 8mm (5/16 or 0.31”) cable to pass through it. This tube is formed to the desired angle on site, allowing the system to change direction easily.



## INSTALLATION

Any fixing through the roof structure is a potential maintenance consideration for the future and additional cost when installing a horizontal life line system. With up to 50% less support posts needed to fix through the roof structure, this system reduces the potential maintenance to an absolute minimum and gives clients a substantial cost saving.

KeeLine® is completely versatile and incorporates an extended intermediate bracket allowing up to 15° adjustment to accommodate variations on site such as ridges, gutters and hipped roofs. The system provides a choice of swage or swageless tensioners and end terminations and incorporates standard 90° or 135° corners.

On steel profile cladded roof designs, it may be possible to use a top fix post, thus avoiding the need to cut through the roof cladding panel in order to fix the support post as with traditional systems. This new technology has been made possible with the design of systems incorporating shock absorbers, collapsible brackets and posts which absorb the shock loading applied to

the cladding panel and fixings. The Horizontal Life Line System is so well engineered that the number of rivets used to attach the top fix post to the roof cladding has been reduced to just twelve rivets where the gauge of the roofing sheet is at least 0.7mm 1/32 or 0.028”.

In some instances it may not be possible to conventionally fix through the roof’s structure. In these cases a free standing fall arrest/restraint solution using the “Linked Kee Anchor” can be provided. A series of Kee Anchors can be linked at approximately 10m (32’) centres via the KeeLine horizontal restraint line. When a bracket/Kee Anchor is encountered, the traveller attaching the operative to the system simply glides over the bracket without the need to detach.

Whilst the operative is attached to the horizontal Life Line a “fall restraint” solution is provided. If the operative needs to go within 2m (6’6”) of the roof edge, then they must attach to an individual Kee Anchor and detach from the horizontal Life Line, this being a “fall arrest” solution.

## CERTIFICATION

KeeLine® Systems conform to the requirements of BS EN 795 2012, ANSI Z359, CSA Z259 and AS/NZS 1821.

## LEGAL REQUIREMENTS

All fall arrest systems & PPE equipment need regular inspection and recertification in accordance with BS EN 365: Personal Protective Equipment against falls from height - General requirements for instruction for use and marking. This can be carried out by Kee Safety as a service contract and included within the quotation for the system. The Work at Height Regulations require that the employer/ building owner has a rescue plan and policy in place for all fall arrest systems

# KeeLine Horizontal Life Line Specification

## PRODUCT SPECIFICATION EN795 (Europe)

**FEATURES :-** A hands free fall protection system for up to three persons.

### GENERAL

A cable based fall arrest/restraint fall protection system for roof tops, façades and overhead applications. The system provides hands free falls from height protection compliant to EN 795 Class C. System incorporates PAS (Progressive Absorbing System) The shock absorbers, intermediate brackets and support posts are designed to deploy and deform should an operative fall, thus reducing the loadings applied to the building's structure to below 10kN.

### MATERIALS

Primary components connecting to the cable are fabricated from 316 Grade Stainless Steel. Secondary components are fabricated from steel to BS EN 10025 S275 Grade and S275JO Grade. All steel components are then hot dipped galvanised to BS EN ISO 1461. All fixings are A2 Grade Stainless Steel. The cable consists of an 8mm 316 grade stainless steel 7 x 7 structure with breaking resistance of >37kN. The system is pre-tensioned to 80daN.

### DESIGN

All systems are designed, as far as possible, to be used as fall restraint systems (At least 2.5m from an leading edge). When designed as fall arrest systems a rescue plan must be incorporated within the design.

The spacing between intermediate supports can be up to 12m (39'). When used overhead this can be extended up to 24m (78") depending on ground clearance and "V" deflection. The system can be used in any horizontal configuration including curves and/or inclinations up to 15°. The system can be installed on various structures using specifically designed posts.

### TRAVELLER

The traveller suits multiple connectors and has been designed to allow entry/exit at any point along the entire length of the system. When mounted at roof level the user can move either side of the cable. This traveller has been engineered with a double action fail safe mechanism and has no mechanical/moving parts which reduces the potential for misuse and maintenance of the system.

### TESTING

All systems have been tested to EN 795 Class C Personal fall protection equipment - Anchor devices.

### ANNUAL RECERTICATION

Annual recertification in accordance with BS EN 365 and BS 7883 is required.

## PRODUCT SPECIFICATION North America & Canada

**FEATURES :-** A hands free fall protection system for up to three persons.

### GENERAL

A cable based fall arrest/restraint fall protection system for roof tops, façades and overhead applications. The system provides hands free falls from height protection compliant to ANSI Z359, CSA Z259 and AS/NZS 1821. System incorporates PAS (Progressive Absorbing System) The shock absorbers, intermediate brackets and support posts are designed to deploy and deform should an operative fall, thus reducing the loadings applied to the building's structure to below 2248lbs (10kN).

### MATERIALS

Primary components connecting to the cable are fabricated from 316 Grade Stainless Steel. Secondary components are fabricated from steel to A283D A529 Gr.D. All steel components are hot dipped galvanised to ASTM A53 & A153. All fixings are A2 Grade Stainless Steel. The cable consists of 5/16 or 0.31" 316 grade stainless steel 7 x 7 structure with breaking resistance of >8318lbs (37kN). The system is pre-tensioned to 80daN.

### DESIGN

All systems are designed, as far as possible, to be used as fall restraint systems (At least 8' from an leading edge). When designed as fall arrest systems a rescue plan must be incorporated within the design.

The spacing between intermediate supports can be up to 39' (12m). When used overhead this can be extended up to 78' (24m) depending on ground clearance and "V" deflection. The system can be used in any horizontal configuration including curves and/or inclinations up to 15°. The system can be installed on various structures using specifically designed posts.

### TRAVELLER

The traveller suits multiple connectors and has been designed to allow entry/exit at any point along the entire length of the system. When mounted at roof level the user can move either side of the cable. This traveller has been engineered with a double action fail safe mechanism and has no mechanical/moving parts which reduces the potential for misuse and maintenance of the system.

### TESTING

KeeLine® Systems conform to the requirements of ANSI Z359, CSA Z259 and AS/NZS 1891.2.

### ANNUAL RECERTICATION

Annual recertification in accordance with National Standards and manufacturers recommendations.

# Typical KeeLine System Layout

Bolted fixing - pitched roof



Chem fix - concrete deck flat roof

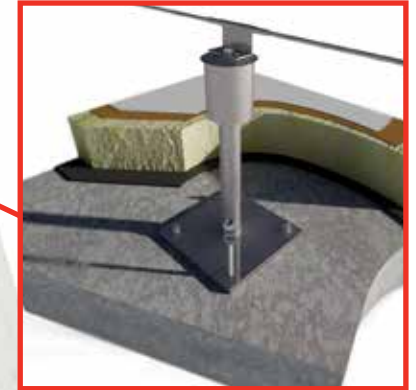

Toggle fix - Tray Liner

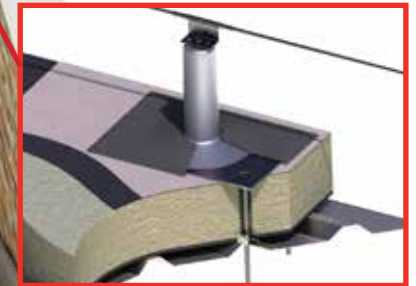

Clamped fixing - standing seam roof

## Fixing Details



Rivet fixing - cladded roof

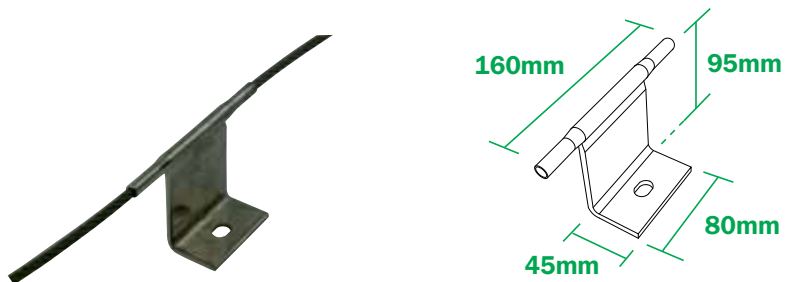

## STANDARD INTERMEDIATE BRACKET - Wall and Roof Mounted INTW010

Designed to allow the Traveller to pass over the brackets without detaching from the system. Maximum span of 12m between Intermediate Brackets. Material : Stainless steel AISI 316L. Breaking strength >12kN. Net weight : 0.49kg.



## CORNER TUBE - Wall mounted 90° - CNR-90-W Wall mounted 135° - CNR-135-W

Allows the system to turn through 90°. Material : Stainless steel AISI 316L. Ø 13.5mm. Net weight : 0.2kg. (Tube only) Net Weight : 1.03kg. (Complete assembly)

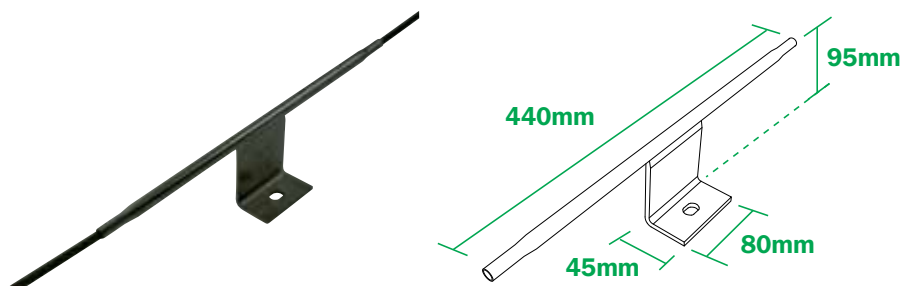

## EXTENDED INTERMEDIATE BRACKET - Wall and Roof Mounted INTEW010

Designed to allow the Traveller to pass over the brackets without detaching from the system. Maximum span of 12m between Intermediate Brackets. Material : Stainless steel AISI 316L. Breaking strength >12kN. Net weight : 0.63kg.

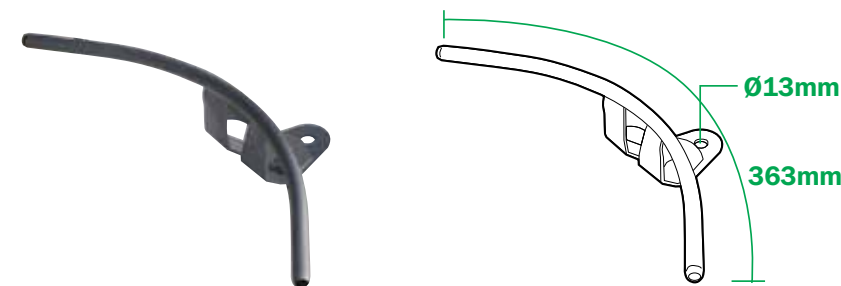

## CORNER BRACKET - Wall and Roof mounted 90° - LAKL20090

Allows the system to turn through 90°. Material : Stainless steel AISI 316L. Ø 13.5mm. Net weight : 0.2kg. (Tube only) Net Weight : 1.03kg. (Complete assembly)

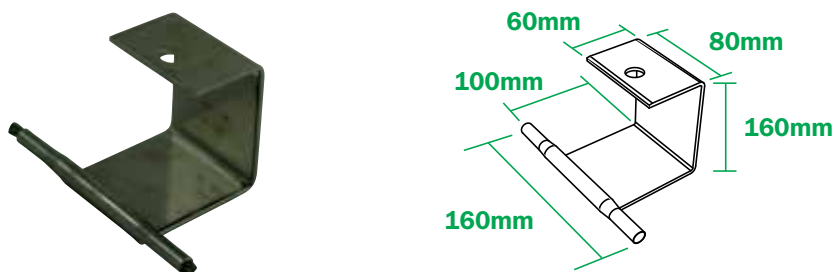

## STANDARD INTERMEDIATE BRACKET - Overhead - KOINT

Designed to allow the Traveller to pass over the brackets without detaching from the system. Maximum span of 24m between Intermediate Brackets. Material : Stainless steel AISI 316L. Breaking strength >12kN. Net weight : 0.63kg.



## CORNER BRACKET - Wall and Roof mounted 45° - LAKL20045

Allows the system to turn through 45°. Material : Stainless steel AISI 316L. Ø 13.5mm. Net weight : 0.38kg.

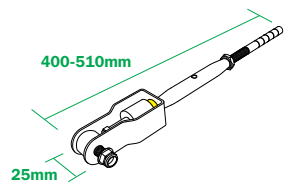

## OVERHEAD TENSIONER AND TENSION INDICATOR - KOTEN

The pretension indicator is a way of instantly adjusting and checking the correct tension of the life line cable. The Tension Indicator (yellow) is set to 3kN when used on an overhead system. Material : Stainless steel AISI 316L. Breaking strength >22kN. Net weight : 1kg.

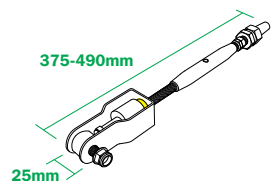

## OVERHEAD SWAGELESS TENSIONER AND TENSION INDICATOR - KOTENS

The pretension indicator is a way of instantly adjusting and checking the correct tension of the life line cable. The Swageless Tension Indicator (yellow) is set to 3kN when used as an overhead system. Material : Stainless steel AISI 316L. Breaking strength >22kN. Net weight : 1.3kg.

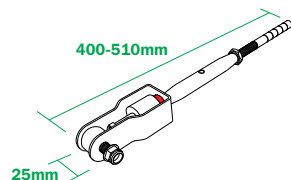

## STANDARD TENSIONER AND TENSION INDICATOR - TENS10

The pretension indicator is a way of instantly adjusting and checking the correct tension of the life line cable. The Tension Indicator (red) is set to 1kN for horizontal systems. Material : Stainless steel AISI 316L. Breaking strength >22kN. Net weight : 1.07kg.

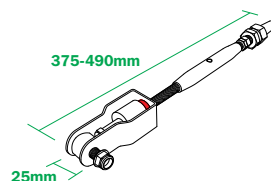

## STANDARD SWAGELESS TENSIONER AND TENSION INDICATOR - LA-SWTEN

The pretension indicator is a way of instantly adjusting and checking the correct tension of the life line cable. The Swageless Tension Indicator (red) is set to 1kN for horizontal systems. Material : Stainless steel AISI 316L. Breaking strength >22kN. Net weight : 1.21kg.

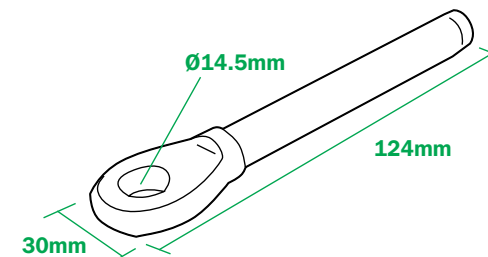

## SWAGE END FITTING - LAKL2HEX8

A swage connection ensures secure assembly of the Cable (diam 8mm) to the End Anchor. Material : Stainless steel AISI 316L. Breaking strength >22kN. Net weight : 0.13kg.

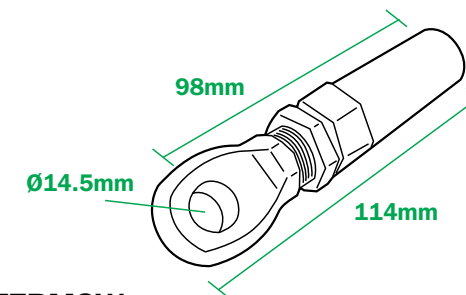

## SWAGELESS END FITTING - LA-TERMSW

A swageless connection ensures secure assembly of the Cable (diam 8mm) to the End Anchor. Material : Stainless steel AISI 316L. Breaking strength >22kN. Net weight : 0.26kg.

	<b>RESTRAINT SYSTEM</b> <small>SEPARATING PEOPLE FROM HAZARDS</small>									
	<table border="0"> <tr><td>SYSTEM NUMBER</td><td><input type="text"/></td></tr> <tr><td>INSTALLATION DATE</td><td><input type="text"/></td></tr> <tr><td>MAX NUMBER OF USERS</td><td><input type="text"/></td></tr> <tr><td>LANYARD LENGTH NOT TO EXCEED</td><td><input type="text"/></td></tr> <tr><td>ANNUAL INSPECTION RECOMMENDED</td><td><input type="text"/></td></tr> </table>	SYSTEM NUMBER	<input type="text"/>	INSTALLATION DATE	<input type="text"/>	MAX NUMBER OF USERS	<input type="text"/>	LANYARD LENGTH NOT TO EXCEED	<input type="text"/>	ANNUAL INSPECTION RECOMMENDED
SYSTEM NUMBER	<input type="text"/>									
INSTALLATION DATE	<input type="text"/>									
MAX NUMBER OF USERS	<input type="text"/>									
LANYARD LENGTH NOT TO EXCEED	<input type="text"/>									
ANNUAL INSPECTION RECOMMENDED	<input type="text"/>									
<small> <b>HEAD OFFICE</b>                      Kee Safety Limited                      Cradley Business Park                      Overend Road                      Cradley Heath                      West Midlands B64 7DW                      (t) +44 (0) 1384 632 188                      (f) +44 (0) 1384 632 192                      (e) info@keesafety.co.uk                      (w) www.keesafety.co.uk                 </small>	<p align="center">● RE-TEST ONLY TO BE CARRIED OUT BY AUTHORISED SERVICE AGENT.</p>									

	<b>FALL ARREST SYSTEM</b> <small>SEPARATING PEOPLE FROM HAZARDS</small>									
	<table border="0"> <tr><td>SYSTEM NUMBER</td><td><input type="text"/></td></tr> <tr><td>INSTALLATION DATE</td><td><input type="text"/></td></tr> <tr><td>MAX NUMBER OF USERS</td><td><input type="text"/></td></tr> <tr><td>LANYARD LENGTH NOT TO EXCEED</td><td><input type="text"/></td></tr> <tr><td>ANNUAL INSPECTION RECOMMENDED</td><td><input type="text"/></td></tr> </table>	SYSTEM NUMBER	<input type="text"/>	INSTALLATION DATE	<input type="text"/>	MAX NUMBER OF USERS	<input type="text"/>	LANYARD LENGTH NOT TO EXCEED	<input type="text"/>	ANNUAL INSPECTION RECOMMENDED
SYSTEM NUMBER	<input type="text"/>									
INSTALLATION DATE	<input type="text"/>									
MAX NUMBER OF USERS	<input type="text"/>									
LANYARD LENGTH NOT TO EXCEED	<input type="text"/>									
ANNUAL INSPECTION RECOMMENDED	<input type="text"/>									
<small> <b>HEAD OFFICE</b>                      Kee Safety Limited                      Cradley Business Park                      Overend Road                      Cradley Heath                      West Midlands B64 7DW                      (t) +44 (0) 1384 632 188                      (f) +44 (0) 1384 632 192                      (e) info@keesafety.co.uk                      (w) www.keesafety.co.uk                 </small>	<p align="center">● RE-TEST ONLY TO BE CARRIED OUT BY AUTHORISED SERVICE AGENT.</p>									

## SYSTEM PLAQUE - SL111/1

Provides details of the system and approvals. Material : plastic. Component weight : 0.085kg.



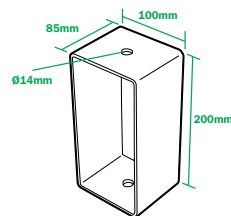

## KL2 METAL ROOF EXTREMITY POST - KL2STEX

This post provides a standard method of connecting the system directly to the Base Plate.  
Material : Galvanised steel to BS EN ISO 1461. Net weight : 1.8Kg.

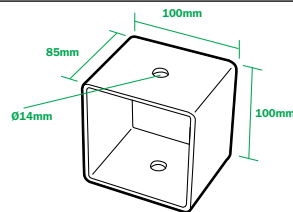

## KL2 METAL ROOF INTERMEDIATE & CORNER POST- KL2STIC

This post provides a standard method of connecting the system directly to the Base Plate.  
Material : Galvanised steel to BS EN ISO 1461. Net weight : 0.974kg.

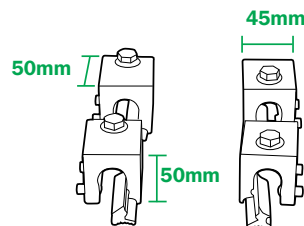

## STANDING SEAM CLAMPS - Z5

These are used in conjunction with the Base Plate Metal Roofs – SPS10 to connect the plate to the roof structure. Material : Aluminium and stainless steel. Net weight : 1.04kg.

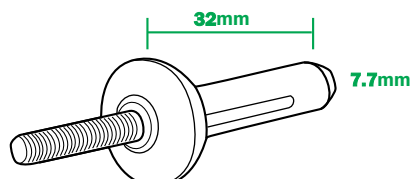

## 7.7 BULB TITLE RIVIT EPDM SEALING WASHER (QTY 100) - KL2RIVIT

These are used in conjunction with the Base Plate Metal Roofs – SPS10 to connect the plate to the roof structure. Material : Aluminium. Net weight : 1kg per 100.

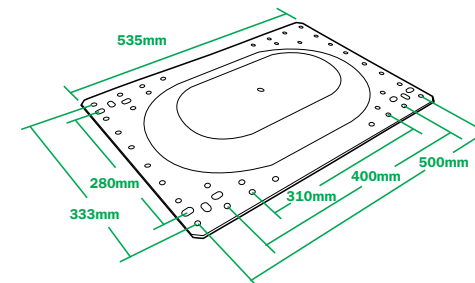

## BASE PLATE METAL ROOFS - SPS10

This plate provides a method of connecting the system to a metal roof structure. Metal roof panels with minimum steel thickness 0.7mm require 3 Rivets per corner. Includes Butyl Sealing Strip to maintain roof's integrity (TA-SEAL 15m roll) Fixing centres: 500, 400, 333, 310. Composite roof panels with minimum steel thickness 0.5mm thick require 3 Rivets per corner. Includes Butyl Sealing Strip to maintain the roof's integrity (TA-SEAL 15m roll) Fixing centres: 333 mm

### Standing seam roofs

Designed to clamp on to the standing seam of a proprietary roofing sheet.

Fixed with non penetrative Z5 clamps

Fixing centres: 305, 400, 500mm

Z5 (4 per pkt) Material : Galvanised steel to BS EN ISO 1461. Net weight : 5.75kg.

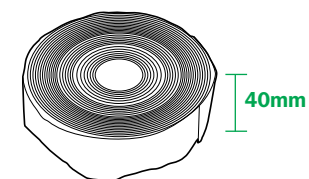

## SEALING STRIP (15M ROLL) - TA-SEAL

This is used in conjunction with the Base Plate Metal Roofs – SPS10 to form a seal between the underside of the plate and the metal decking. Material : Butyl. Net weight : 4kg.

## FIXINGS (TYPE AND QUANTITY AVAILABLE ON REQUEST)

LAM122050 - M12 X 20MM HEX HEAD SCREW SET

LAM122550 - M12 X 25MM HEX HEAD SCREW SET

LAM124050 - M12 X 40MM HEX HEAD SET SCREW

LAW122450 - M12 X 24MM FLAT WASHER

531M12000250 - M12 SPRING WASHER

NLKM01250 - M12 NYLOC NUT

Net weight : 0.15kg.





## TRAVELLER - KL2TRAV

Designed to enable the user to move easily and safely along the Life Line. When mounted at roof level the user can move either side of the cable. A spring loaded pin fastens the Traveller on to the Cable. The connector is attached to the Traveller, thus locking the Traveller onto the Cable. The Traveller can be connected and disconnected at any point along the system.

Material : Z8CND17 04 Stainless steel. Breaking strength 12kN. Net weight : 0.3kg.

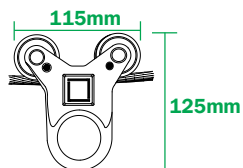

## OVERHEAD WHEELED TRAVELLER - KOTRAV

Designed to enable the user to move easily and safely along the Life Line. The Traveller is permanently fitted to the overhead system cable. It is manufactured with brass bushes, thus no bearings to wear.

Material : Z8CND17 04 Stainless steel. Breaking strength 12kN. Net weight : 0.68kg.

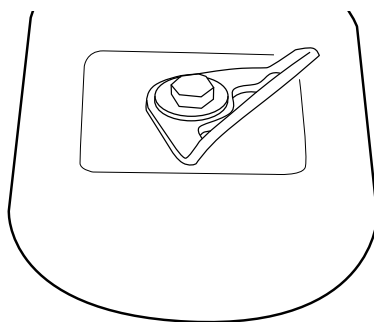

## SINGLE POINT ANCHOR & ASSEMBLY KIT - LAKL20SPA

This provides a single anchor point.

The design permits complete 360° rotation.

The kit comes complete with Bolt, Bush, Sealing Washer, Label and Screw Plastic Cover.

Material : Stainless Steel.

Net weight : 0.176kg



## CABLE - ROPE8SS7x7

Stainless steel AISI 316L 8mm diameter 7x7 structure with breaking strength > 37kN, is suitable for spans of up to 12m horizontal & overhead up to 30m between Intermediate Brackets. Net weight : 0.28kg. per metre.

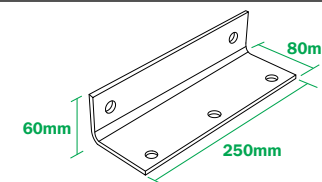

## EXTREMITY FIXING BRACKET - LINE-XBRKT

The fixing bracket is designed to terminate the Life Line System at either end and is intended to provide direct attachment for Tensioners, Absorbers and pretension indicators. Alternative end components may be used, depending on the type of assembly.

Material : Stainless steel AISI 316L. Breaking strength >22kN. Net weight : 1.24kg.

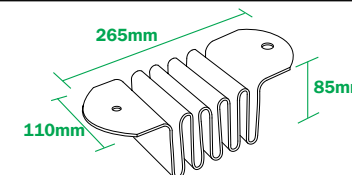

## ENERGY ABSORBER - (STEEL - ABSORBER) (STAINLESS STEEL- LABSORB50)

The Energy Absorber is designed to dissipate the energy generated throughout the system and reduce the end loadings to below 10kN. Installations require an absorber to be installed at both ends of the system. The element is a disposable device which must be replaced after each fall.

Material : Galvanised steel BS EN ISO 1461. Breaking strength >22kN. Stainless Steel AISI 316L. Breaking strength >22kN. Activating force minimum 2.9kN. Net weight : 3.6kg.

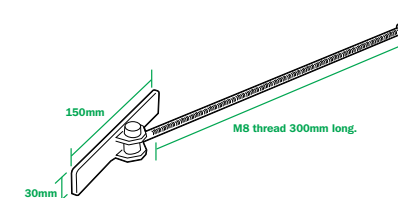

## KL2 TOGGLES (PACK of 4No) - KL2TOG4

These are used in conjunction with the Flat Roof Post – LAKL2POST to connect the post to the roof structure. Length Standard 300mm Ø M8. Material : Steel Grade 8.8. Net weight : 0.258kg no thread.

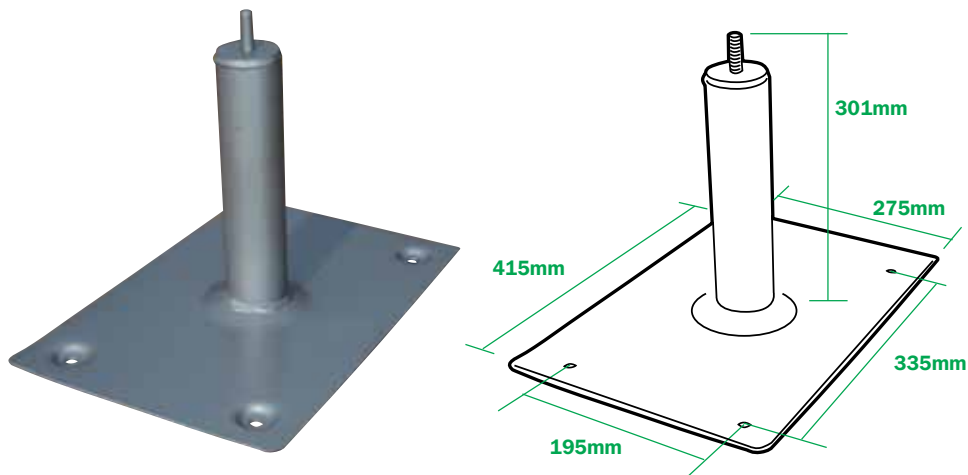

## STANDARD FLAT ROOF POST- LAKL2POST

This post provides a standard method of connecting the system directly to the flat roof structure. The Flat Roof Post can be installed on top of the insulation and waterproof membrane via a toggle or chemical fixing. Cowling for weather detail selected separately.  
Material : Stainless Steel AISI. Net weight Post : 4.168kg.

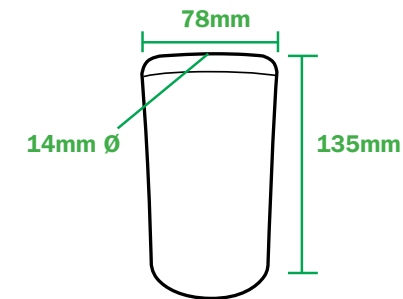
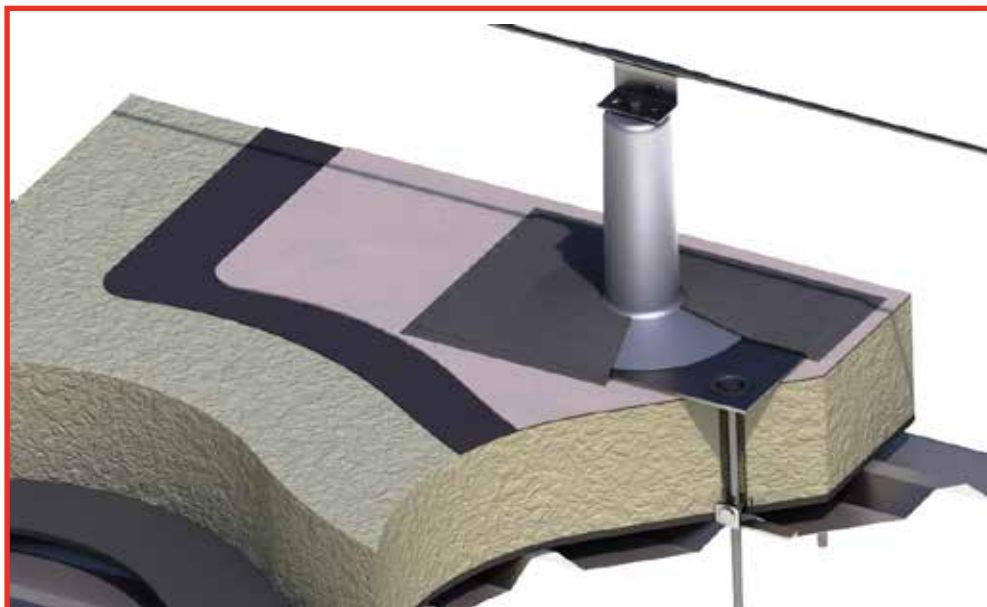

## WEATHER CAP 120 DIA GALVANISED - WC120

This Cowling provides the weatherproofing detail.  
Material : Galvanised steel to BS EN ISO 1461. Net weight Cowling : 0.167kg.

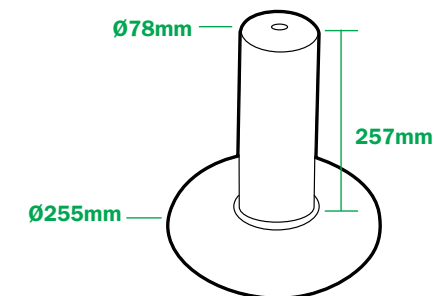

## WEATHER COWLING - NON-COATED - LAKL20ALU

This Cowling provides the weatherproofing detail supplied non-coated  
Material : Aluminium. Net weight : 0.396kg.

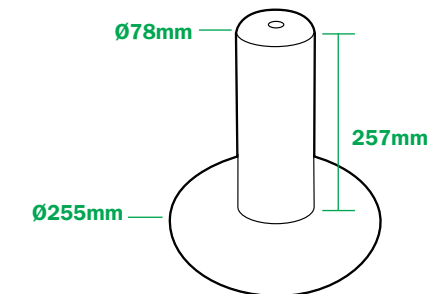

## WEATHER COWLING - COATED - LAKL20PVC

This Cowling provides the weatherproofing detail supplied pre-coated for torchon single ply membranes  
Material : Aluminium. Net weight : 0.494kg.

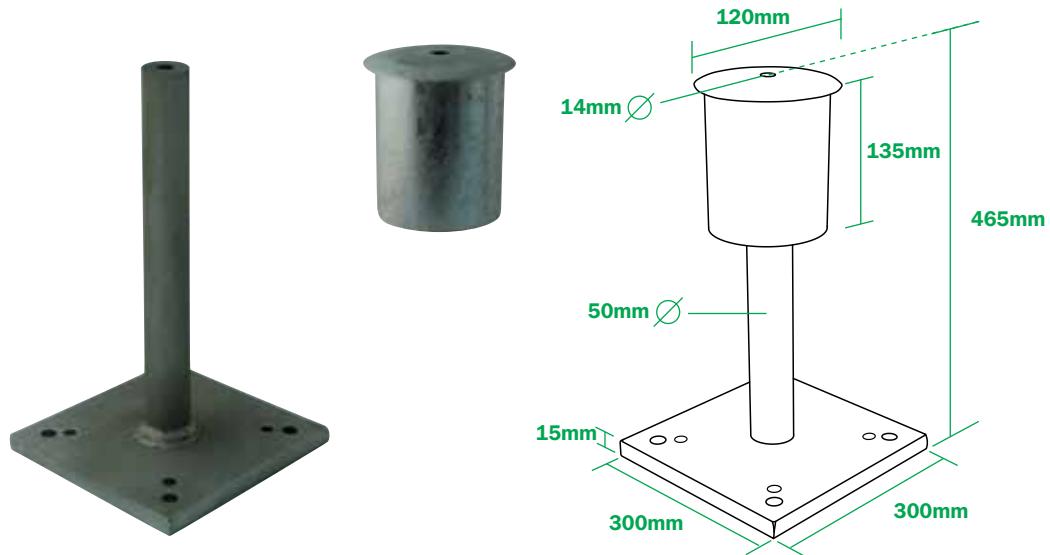

### UNIVERSAL POSTANKA - TYPE 6 - T6SS450

This post provides a standard method of connecting the system directly to the structure. Cowling for weather detail supplied seperately. Additional components (wings) can be provided for bespoke installations.

Material : Galvanised steel to BS EN ISO 1461. Net weight Post : 17.8kg. Cowling : 1kg.

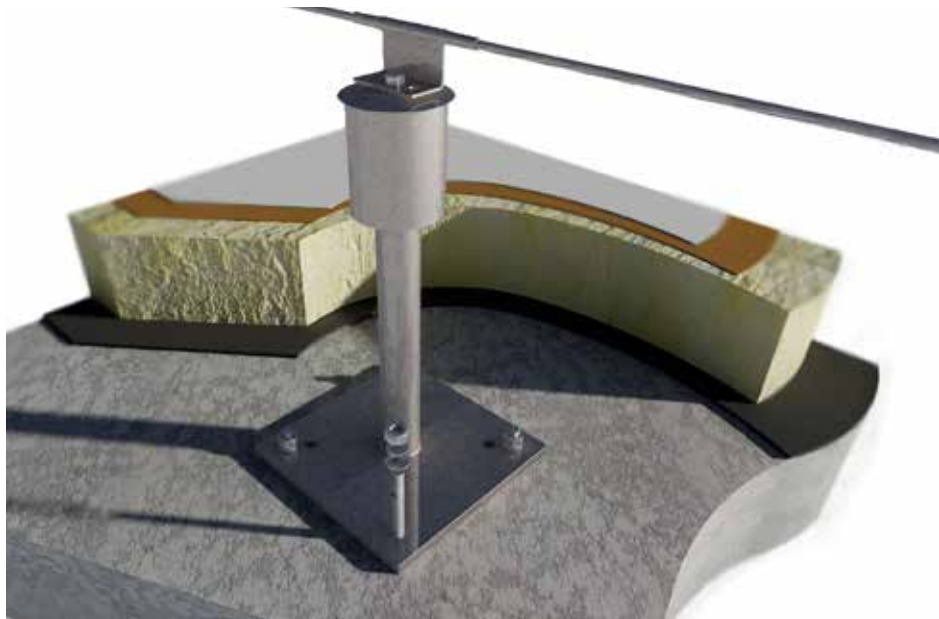

## Attaching the Traveller

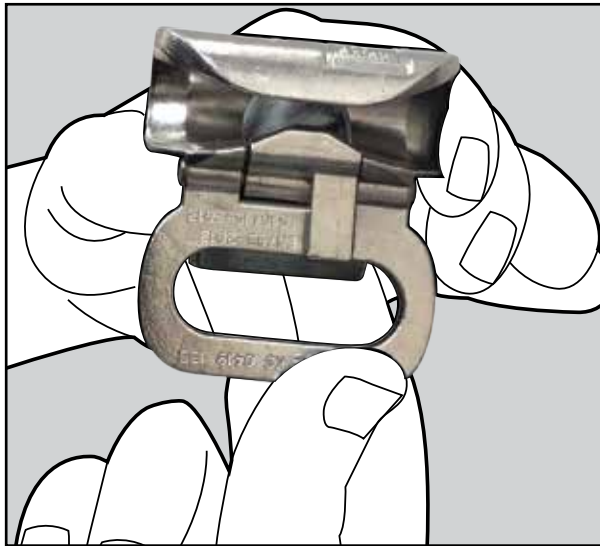

**1)** Take the traveller in one hand.



**3)** Place the traveller on the Horizontal Life Line.



**5)** Place the karabiner through the traveller

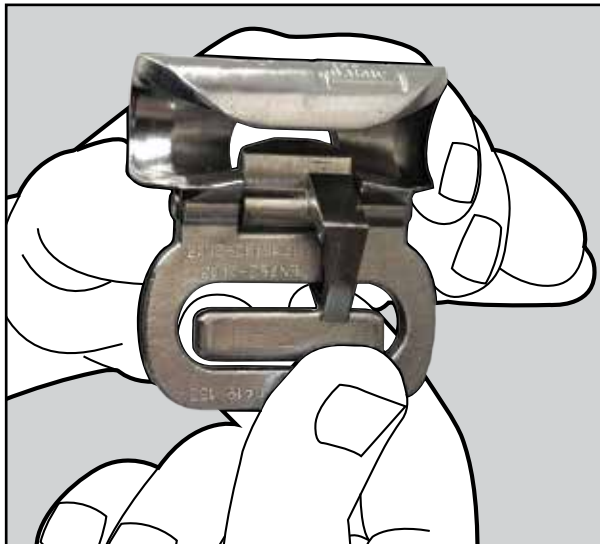

**2)** With the other push the pin in and open the traveller.

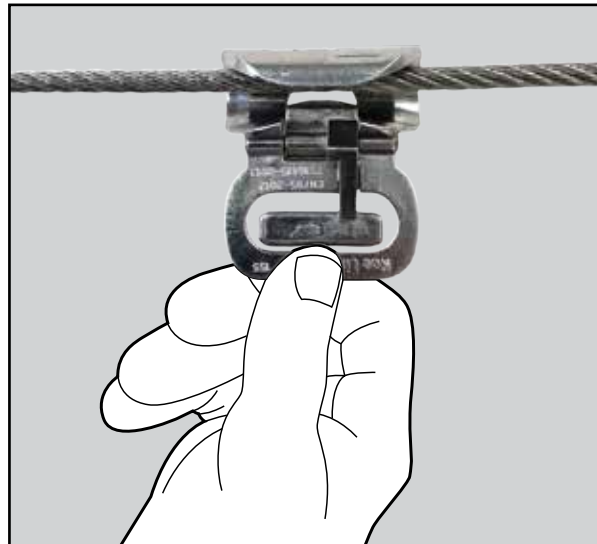

**4)** Close the traveller, the pin will now re-engage.

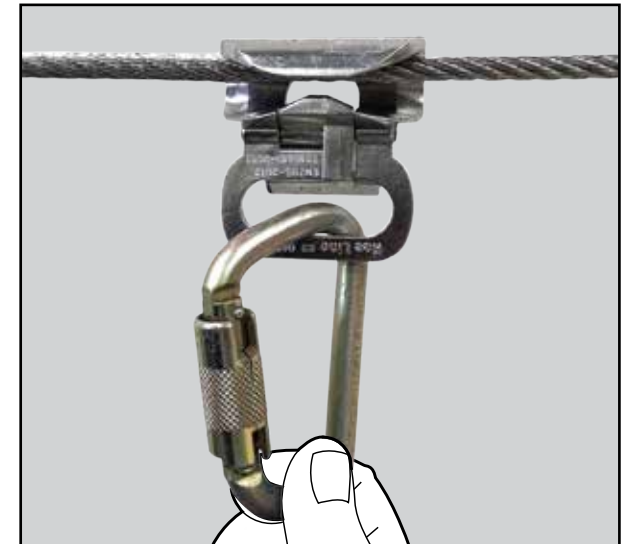

**6)** Ensure that all locking devices are closed within the karabiner

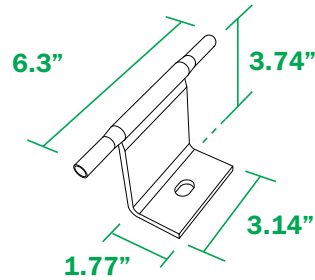

### STANDARD INTERMEDIATE BRACKET - Wall and Roof Mounted INTW010

Designed to allow the Traveller to pass over the brackets without detaching from the system. Maximum span of 39' between Intermediate Brackets. Material : Stainless steel AISI 316L. Breaking strength >2698lbs. Net weight : 14oz.

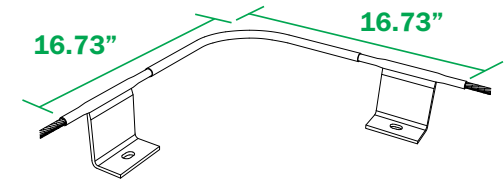

### CORNER TUBE - Wall mounted 90° - CNR-90-W Wall mounted 135° - CNR-135-W

Allows the system to turn through 90°. Material : Stainless steel AISI 316L. Ø 0.53". Net weight : 7oz. (Tube only) Net Weight : 2lb 4oz. (Complete assembly)

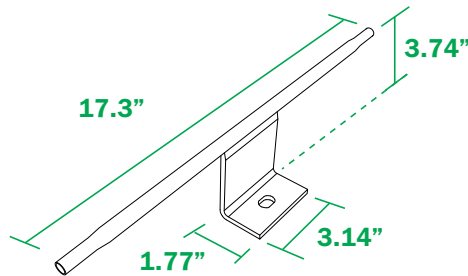

### EXTENDED INTERMEDIATE BRACKET - Wall and Roof Mounted INTEW010

Designed to allow the Traveller to pass over the brackets without detaching from the system. Maximum span of 39' between Intermediate Brackets. Material : Stainless steel AISI 316L. Breaking strength >2698lbs. Net weight : 1lb 6oz.

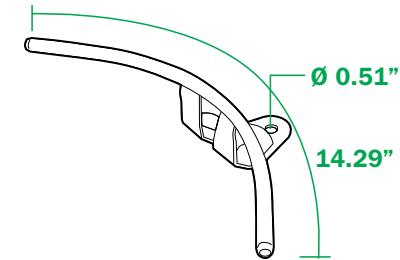

### CORNER BRACKET - Wall and Roof mounted 90° - LAKL20090

Allows the system to turn through 90°. Material : Stainless steel AISI 316L. Ø 0.53". Net weight : 1lb 4oz.

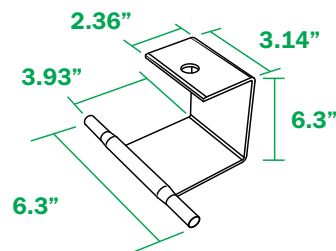

### STANDARD INTERMEDIATE BRACKET - Overhead - KOINT

Designed to allow the Traveller to pass over the brackets without detaching from the system. Maximum span of 78' between Intermediate Brackets. Material : Stainless steel AISI 316L. Breaking strength >2698lbs. Net weight : 1lb 12oz.

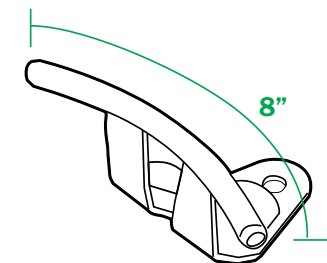

### CORNER BRACKET - Wall and Roof mounted 45° - LAKL20045

Allows the system to turn through 45°. Material : Stainless steel AISI 316L. Ø 0.53". Net weight : 14oz.

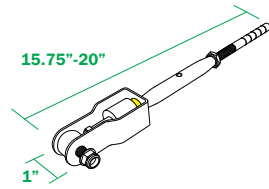

## OVERHEAD TENSIONER AND TENSION INDICATOR - KOTEN

The pretension indicator is a way of instantly adjusting and checking the correct tension of the life line cable. The Tension Indicator (yellow) is set to 675lbs when used on an overhead system. Material : Stainless steel AISI 316L. Breaking strength >5000lbs. Net weight : 2lb 3oz.

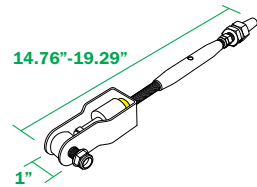

## OVERHEAD SWAGELESS TENSIONER AND TENSION INDICATOR - KOTENS

The pretension indicator is a way of instantly adjusting and checking the correct tension of the life line cable. The Swageless Tension Indicator (yellow) is set to 675lbs when used as an overhead system. Material : Stainless steel AISI 316L. Breaking strength >5000lbs. Net weight : 2lb 14oz.

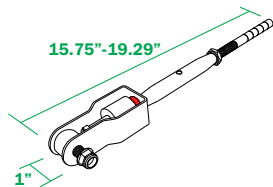

## STANDARD TENSIONER AND TENSION INDICATOR - TENS10

The pretension indicator is a way of instantly adjusting and checking the correct tension of the life line cable. The Tension Indicator (red) is set to 225lbs for horizontal systems. Material : Stainless steel AISI 316L. Breaking strength >5000lbs. Net weight : 2lb 6oz.

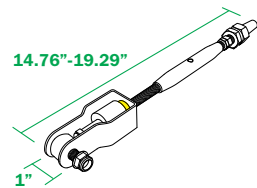

## STANDARD SWAGELESS TENSIONER AND TENSION INDICATOR - LA-SWTEN

The pretension indicator is a way of instantly adjusting and checking the correct tension of the life line cable. The Swageless Tension Indicator (red) is set to 225lbs for horizontal systems. Material : Stainless steel AISI 316L. Breaking strength >5000lbs. Net weight : 2lb 10oz.

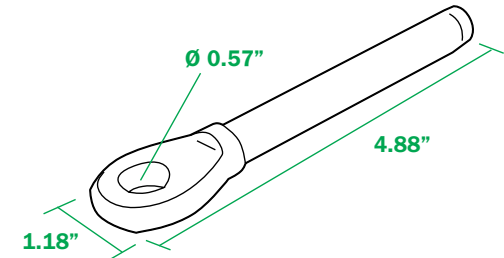

## SWAGE END FITTING - LAKL2HEX8

A swage connection ensures secure assembly of the Cable (diam 8mm) to the End Anchor. Material : Stainless steel AISI 316L. Breaking strength >22kN. Net weight : 4oz.

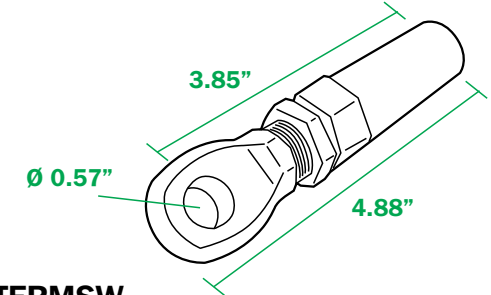

## SWAGELESS END FITTING - LA-TERMSW

A swageless connection ensures secure assembly of the Cable (diam 8mm) to the End Anchor. Material : Stainless steel AISI 316L. Breaking strength >22kN. Net weight : 9oz.

	<b>RESTRAINT SYSTEM</b> <small>SEPARATING PEOPLE FROM HAZARDS</small>									
	<table border="0"> <tr><td>SYSTEM NUMBER</td><td><input type="text"/></td></tr> <tr><td>INSTALLATION DATE</td><td><input type="text"/></td></tr> <tr><td>MAX NUMBER OF USERS</td><td><input type="text"/></td></tr> <tr><td>LANYARD LENGTH NOT TO EXCEED</td><td><input type="text"/></td></tr> <tr><td>ANNUAL INSPECTION RECOMMENDED</td><td><input type="text"/></td></tr> </table>	SYSTEM NUMBER	<input type="text"/>	INSTALLATION DATE	<input type="text"/>	MAX NUMBER OF USERS	<input type="text"/>	LANYARD LENGTH NOT TO EXCEED	<input type="text"/>	ANNUAL INSPECTION RECOMMENDED
SYSTEM NUMBER	<input type="text"/>									
INSTALLATION DATE	<input type="text"/>									
MAX NUMBER OF USERS	<input type="text"/>									
LANYARD LENGTH NOT TO EXCEED	<input type="text"/>									
ANNUAL INSPECTION RECOMMENDED	<input type="text"/>									
<small> <b>HEAD OFFICE</b>                      Kee Safety Limited                      Cradley Business Park                      Overend Road                      Cradley Heath                      West Midlands B64 7DW                      (t) +44 (0) 1384 632 188                      (f) +44 (0) 1384 632 192                      (e) info@keesafety.co.uk                      (w) www.keesafety.co.uk                 </small>	<p align="center">● RE-TEST ONLY TO BE CARRIED OUT BY AUTHORISED SERVICE AGENT.</p>									

	<b>FALL ARREST SYSTEM</b> <small>SEPARATING PEOPLE FROM HAZARDS</small>									
	<table border="0"> <tr><td>SYSTEM NUMBER</td><td><input type="text"/></td></tr> <tr><td>INSTALLATION DATE</td><td><input type="text"/></td></tr> <tr><td>MAX NUMBER OF USERS</td><td><input type="text"/></td></tr> <tr><td>LANYARD LENGTH NOT TO EXCEED</td><td><input type="text"/></td></tr> <tr><td>ANNUAL INSPECTION RECOMMENDED</td><td><input type="text"/></td></tr> </table>	SYSTEM NUMBER	<input type="text"/>	INSTALLATION DATE	<input type="text"/>	MAX NUMBER OF USERS	<input type="text"/>	LANYARD LENGTH NOT TO EXCEED	<input type="text"/>	ANNUAL INSPECTION RECOMMENDED
SYSTEM NUMBER	<input type="text"/>									
INSTALLATION DATE	<input type="text"/>									
MAX NUMBER OF USERS	<input type="text"/>									
LANYARD LENGTH NOT TO EXCEED	<input type="text"/>									
ANNUAL INSPECTION RECOMMENDED	<input type="text"/>									
<small> <b>HEAD OFFICE</b>                      Kee Safety Limited                      Cradley Business Park                      Overend Road                      Cradley Heath                      West Midlands B64 7DW                      (t) +44 (0) 1384 632 188                      (f) +44 (0) 1384 632 192                      (e) info@keesafety.co.uk                      (w) www.keesafety.co.uk                 </small>	<p align="center">● RE-TEST ONLY TO BE CARRIED OUT BY AUTHORISED SERVICE AGENT.</p>									

## SYSTEM PLAQUE - SL111/1

Provides details of the system and approvals. Material : plastic. Component weight : 3oz

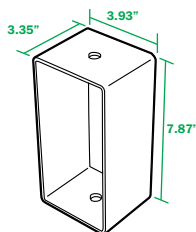

## KL2 METAL ROOF EXTREMITY POST - KL2STEX

This post provides a standard method of connecting the system directly to the Base Plate.  
Material : Galvanised steel to ASTM A53. Net weight : 3lb 15oz.

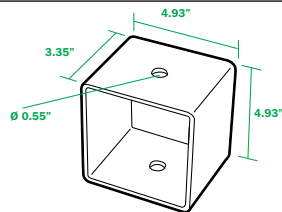

## KL2 METAL ROOF INTERMEDIATE & CORNER POST - KL2STIC

This post provides a standard method of connecting the system directly to the Base Plate.  
Material : Galvanised steel to ASTM A53. Net weight : 2lb 8oz.

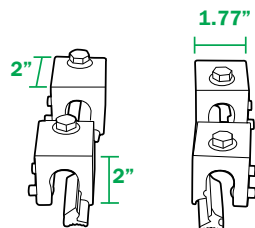

## STANDING SEAM CLAMPS - Z5

These are used in conjunction with the Base Plate Metal Roofs – LABASUS10 to connect the plate to the roof structure. Material : Aluminium and stainless steel. Net weight : 2lb 4oz.

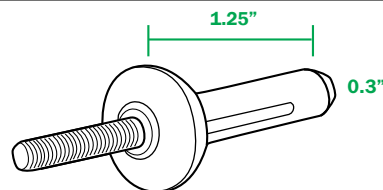

## 7.7 BULB TITLE RIVIT EPDM SEALING WASHER (QTY 100) - KL2RIVIT

These are used in conjunction with the Base Plate Metal Roofs – LABASUS10 to connect the plate to the roof structure. Material : Aluminium. Net weight : 2lb 4oz per 100.

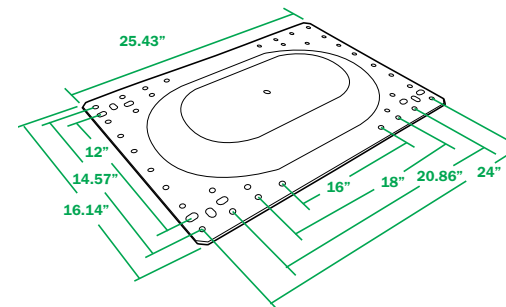

## BASE PLATE METAL ROOFS - LABASUS10

This plate provides a method of connecting the system to a metal roof structure. Metal roof panels with minimum steel thickness 0.027" require 3 Rivets per corner. Includes Butyl Sealing Strip to maintain roof's integrity (TA-SEAL 49' roll) Fixing centres: 16", 18", 20.86", 27.95". Composite roof panels with minimum steel thickness 0.02" thick require 3 Rivets per corner. Includes Butyl Sealing Strip to maintain the roof's integrity (TA-SEAL 49' roll) Fixing centres: 12" or 14.56"

### Standing seam roofs

Designed to clamp on to the standing seam of a proprietary roofing sheet.  
Fixed with non penetrative Z5 clamps  
Fixing centres: 16", 18", 20.86", 27.95"  
Z5 (4 per pkt) Material : Galvanised steel to ASTM A53. Net weight : 12lb 11oz.

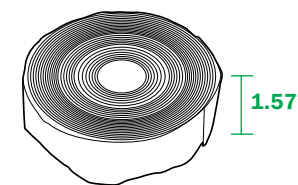

## SEALING STRIP (15M ROLL) - TA-SEAL

This is used in conjunction with the Base Plate Metal Roofs – LABASUS10 to form a seal between the underside of the plate and the metal decking. Material : Butyl. Net weight : 8lb 13oz.

## FIXINGS (TYPE AND QUANTITY AVAILABLE ON REQUEST)

- 1- 0.5" x 1.18" stainless steel hex head set screw
  - 1- 0.5" x 1.57" stainless steel hex head set screw
  - 2- 0.5" x 1.37" stainless steel flat washer
  - 2- 0.5" stainless steel spring washer
  - 2- 0.5" stainless steel flat washer
  - 2- 0.5" stainless steel nyloc nut
- Net weight : 5oz.







# KeeLine Components - North America

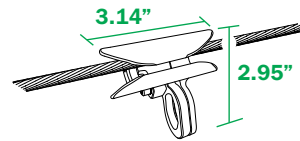

## TRAVELLER - LINE-MINI

Designed to enable the user to move easily and safely along the Life Line. When mounted at roof level the user can move either side of the cable. A spring loaded pin fastens the Traveller on to the Cable. The connector is attached to the Traveller, thus locking the Traveller onto the Cable. The Traveller can be connected and disconnected at any point along the system. Material : Z8CND17 04 Stainless steel. Breaking strength 2698lbs. Net weight: 10oz.

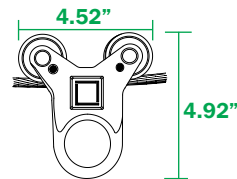

## OVERHEAD WHEELED TRAVELLER - KOTRAV

Designed to enable the user to move easily and safely along the Life Line. The Traveller is permanently fitted to the overhead system cable. It is manufactured with brass bushes, thus no bearings to wear. Material : Z8CND17 04 Stainless steel. Breaking strength 2698lbs. Net weight : 1lb 8oz

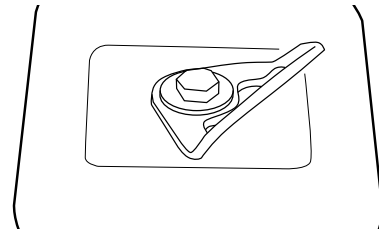

## SINGLE POINT ANCHOR & ASSEMBLY KIT - LAKL20SPA

This provides a single anchor point. The design permits complete 360° rotation. The kit comes complete with Bolt, Bush, Sealing Washer, Label and Screw Plastic Cover. Material : Stainless steel. Net weight : 6oz.

## CABLE - ROPE8SS7x7

Stainless steel AISI 316L 5/16 or 0.31" diameter 7x7 structure with breaking strength > 8318lbs, is suitable for spans of up to 39' horizontal & overhead up to 78' between Intermediate Brackets. Net weight : 3oz per foot.

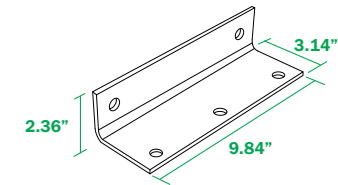

## EXTREMITY FIXING BRACKET - LINE-XBRKT

The fixing bracket is designed to terminate the Life Line System at either end and is intended to provide direct attachment for Tensioners, Absorbers and pretension indicators. Alternative end components may be used, depending on the type of assembly. Material : Stainless steel AISI 316L. Breaking strength >5000lbs. Net weight : 2lb 12oz

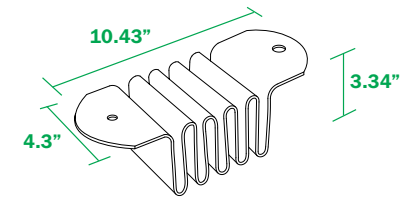

## ENERGY ABSORBER - (STEEL - ABSORBER) (STAINLESS STEEL- LABSORB50)

The Energy Absorber is designed to dissipate the energy generated throughout the system and reduce the end loadings to below 2248lbs. Installations require an absorber to be installed at both ends of the system. The element is a disposable device which must be replaced after each fall. Material : Galvanised steel ASTM A53. Breaking strength >5000lbs. Stainless Steel AISI 316L. Breaking strength >5000lbs. Activating force minimum 2.9kN. Net weight : 7lb 15oz.

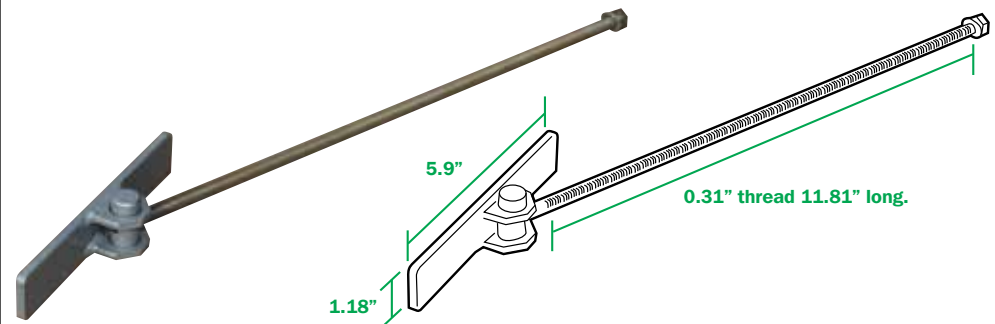

## KL2 TOGGLES (PACK of 4No) - KL2TOG4

These are used in conjunction with the STANDARD FLAT ROOF POST- LAKL2POST to connect the post to the roof structure. Material: Steel Grade 8.8. Standard length 11.81" (0.31" diameter) Net weight : 9oz.

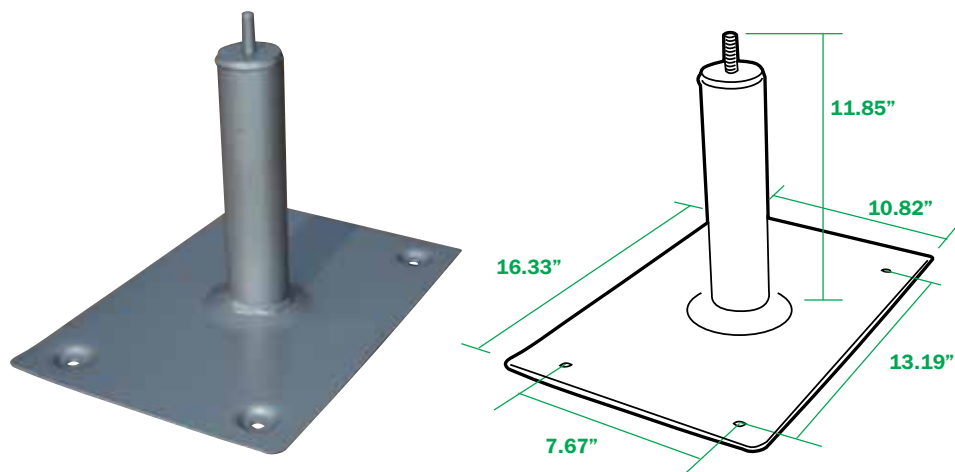

### STANDARD FLAT ROOF POST- LAKL2POST

This post provides a standard method of connecting the system directly to the flat roof structure. The Flat Roof Post can be installed on top of the insulation and waterproof membrane via a toggle or chemical fixing. Cowling for weather detail selected separately.  
Material : Stainless Steel AISI 316. Net weight Post : 9lb 8oz.

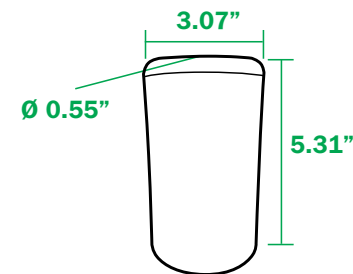
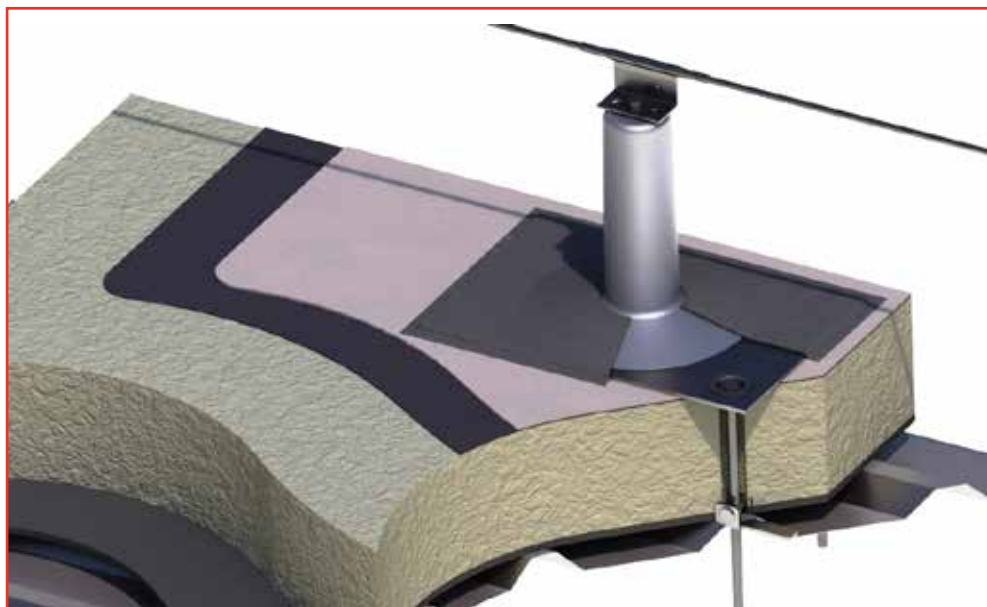

### WEATHER CAP 120 DIA GALVANISED - WC120

This Cowling provides the weatherproofing detail.  
Material : Galvanised steel to ASTM A53. Net weight Cowling : 2.2lb.

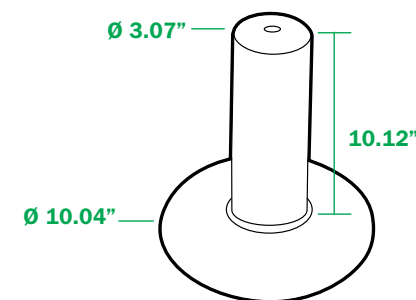

### WEATHER COWLING - NON-COATED - LAKL20ALU

This Cowling provides the weatherproofing detail supplied non-coated  
Material : Aluminium. Net weight : 14oz.

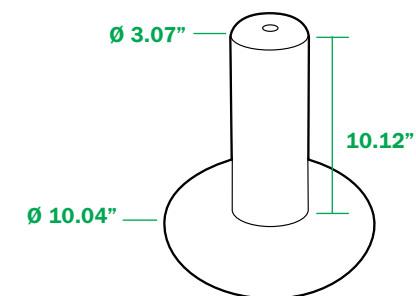

### WEATHER COWLING - COATED - LAKL20PVC

This Cowling provides the weatherproofing detail supplied pre-coated for torchon single ply membranes. Material : Aluminium. Net weight : 1lb 1oz.

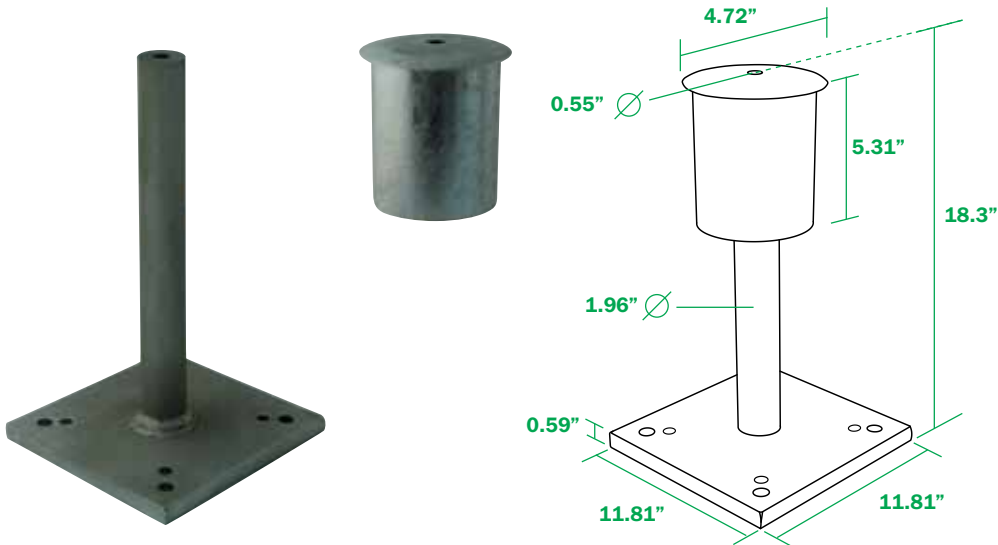

**UNIVERSAL POSTANKA - TYPE 6 - T6SS450**

This post provides a standard method of connecting the system directly to the structure. Cowling for weather detail supplied seperately. Additional components (wings) can be provided for bespoke installations.

Material : Galvanised steel to ASTM A53. Net weight Post : 17.8kg. Cowling : 2lb 3oz.

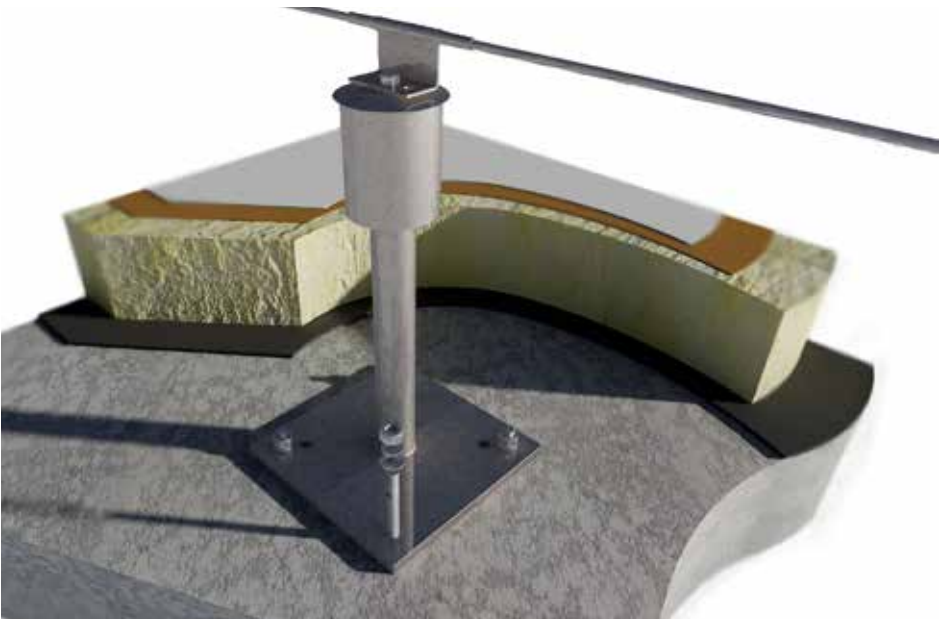

# Personal Fall Protection Systems

## PERSONAL FALL PROTECTION SYSTEMS

Personal fall protection systems are required when an operative is working at an elevated level with an unprotected side or edge, which can be at any height. The system must be designed in such a way to prevent the operative from free falling more than 2m (6'6") or striking a lower level. There are two ways that a company can accomplish this task: Fall Restraint or Fall Arrest.

## FALL RESTRAINT SYSTEM

This system does exactly what it states. It is designed in such a way as to restrain the user from falling by not allowing the user to get to the leading edge. With this system the free fall distance is ZERO. Belts can be used with this type of system but a full body harness is recommended. If any possibility of a free fall exists then the user needs to use a Fall Arrest system.

## FALL ARREST SYSTEM

A fall arrest system consists of the following components: Anchor, Connector, Body support and Retrieval.

- Anchors need to have a minimum breaking strength of 10kN or be engineered for a specific system and have a safety factor of 2:1.
- Connectors can consist of one of several different means. A positioning lanyard, a deceleration lanyard, a self-retracting lanyard/life line or a climbing aid device.
- Body support is a full body harness. A full body harness

distributes the fall impact throughout the body and allows the user to better absorb a fall.

- When working in a fall arrest situation it is a legal requirement for the employer/building owner to have a rescue policy and plan in place and not to rely solely on the emergency services. Anyone responsible for or working at height must be trained fully on correct rescue procedures including how to use the rescue kit provided. Should an emergency occur, a competent first aider should be present to assist with the casualty and to follow the standard first aid guidance for the recovery of a person.

## KEY COMPONENTS OF A FALL ARREST SYSTEM

There are a number of issues that need to be addressed when considering using a fall arrest system.

## IMPACT FORCE (European)

The maximum impact force for a full body harness is 6kN and 10kN for the anchorage point. Calculating the impact force is difficult because there are so many variables. These variables include fall distance, person's weight, and attachment method (self retracting life line, shock-absorbing lanyards, etc.). (See Table for North American Fall Protection Regulations)

## EQUIPMENT COMPATIBILITY

It is important that the equipment being used is fully compatible. The entire system needs to be measured by its weakest link. Conventional locking snap hooks need to be used with compatible D-ring connectors. It is a general recommendation that a user does not mix fall protection equipment from various manufacturers in order to avoid compatibility issues and to ensure the manufacturer guarantee of quality and use.

## FREE FALL DISTANCE

In layman's terms, it is the distance that a person falls before any part of the system starts to arrest the fall. Free fall is measured from the anchorage point to the point in which the system started to arrest the fall. This distance excludes deceleration distance and lanyard/harness elongation. Maximum free fall distance is 2m (6'6") or striking a lower level.

## TOTAL FALL DISTANCE

Is measured as the distance the operative fell from the point at which they were standing to the position of their feet after the fall. Free fall and deceleration distances are included in the measurement. See falling distances diagram.

## ANCHORAGE POINTS

Need to be rated at a minimum of 10kN (2248lbs) per person. If engineered, they need to have a 2:1 safety factor. (Minimum USA requirement is 5000lbs.). (See Table for North American Fall Protection Regulations)

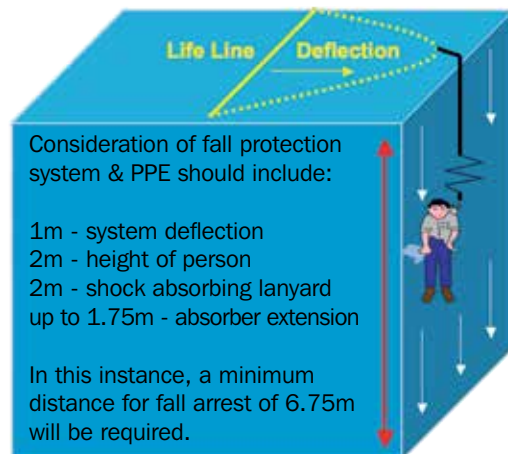

## Typical Pendulum Effect

A, B, C – safe positions D – risk of a fall arrest situation

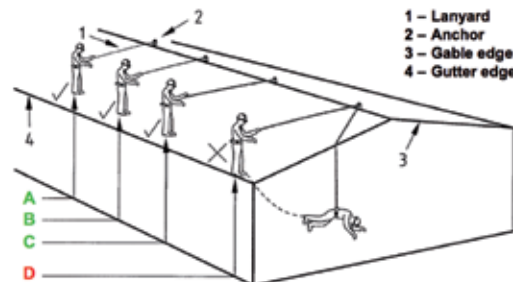

Limitations and dangers of using a restraint system on a sloping roof

Plan of Roof

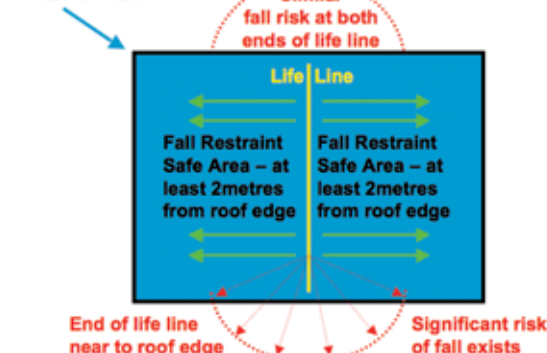

Fall restraint system unsuitable for this roof arrangement



# Personal Fall Protection Systems



North American Fall Protection Regulations	Canadian Federal	British Columbia	Alberta	Saskatchewan	Manitoba	Ontario Industrial	Ontario Construction Industry	Quebec	New Brunswick	PEI	Nova Scotia	Newfoundland & Labrador	Northwest Territories & Nunavut	Yukon	US Fed OSHA General Industry	US Fed Construction Industry
	COSH S2.5, 2.9, 12.10	Reg 420/2004 Parts 4 & 11	Part 9	OH&S Reg. 1996 S102 & 116	Reg 217/2006	ON Reg 851-90	Reg 213/91	LSST C.S-2.1 r.19.01 S346	Act O.C. 91-1035 Reg 1-191	EC633/04	OIC 96-14 Reg 2/96	OC 96-478	Reg C.S-1	O.I.C. 1986/164	CFR 1910.23 & 1910.66	CFR 1926.502
Year of Last Amendment	1994	2007	2009	2007	2006	2006	2005	2006	1991	2004	1996	1996	2000	1986	1994	1994
Threshold of Height for Fall Arrest	8ft	10ft	10ft	10ft	8ft	10ft	10ft	10ft	10ft	10ft	10ft	10ft	10ft	10ft	6ft	6ft
Threshold of Height for Guard Rails (Premanent Work Locations)	4ft	4ft	4ft	4ft	-	3.5ft	8ft	-	4ft	10ft	10ft	-	-	8ft	4ft	-
Maximum Free Fall (* = when no Personal Energy Absorber)	4ft	-	-	4ft	4ft	5ft	-	4ft	4ft	4ft	4ft	4ft	4ft	4ft	6ft	6ft
Maximum Deaccelartion Distance	-	-	-	-	-	-	-	-	-	-	-	-	-	-	3.5ft	3.5ft
Maximum Arretsing Force	1800 lb	-	8 kN	8 kN	8 kN	8 kN	8 kN	-	-	-	-	-	-	-	1800 lb 900 lb	1800 lb 900 lb
<b>Adopted Z259.16</b>	-	Y	Y	-	Y	-	-	-	Y	Y	-	Y	-	-	-	-
Minimum FAS Anchor Strength	4000 lb	5000 lb 2xMAF	3600, Z259.16	5000 lb	(3600 lb) FOS x8 kN	5000 lb	4000 lb	4000 lb	4000 lb	4000 lb	4000 lb	-	-	-	5000 lb 2 x MAF	5000 lb 2 x MAF
Minimum Travel Restraint Anchor Strength	-	800 lb	800 / 3600 lb	800 / 3600 lb	900 lb = FOS x 400 lb	-	900 lb = FOS x 400 lb	-	-	-	-	-	-	-	-	-
Written Fall Protection Plans/Procedures	Y	> 25 ft	> 10 ft	> 10 ft	-	-	Y	-	-	-	-	-	-	-	-	-
Procedures Based Fall Protection	-	Limited	Limited	-	Roofing	-	-	-	-	-	-	-	-	-	-	Limited
Written Rescue Plans/Procedures	-	Y	Y	Y	-	-	-	-	-	-	-	-	-	-	-	-
Training of Workers (F = Fall Protetcion, R = Rescue)	F.R.	F.R.	F.R.	F.R.	-	-	F	-	-	-	-	-	-	-	-	-
Control Zones/Warning Lines	-	-	Y	Y	-	-	-	-	-	-	-	-	-	-	-	Y
Swing Falls/Swing Drop Distance	-	-	4 ft	-	-	-	-	-	-	-	-	-	-	-	-	-
Horizontal Lifelines to Z259 13 or Z259 18	-	Z259.13 Z259.16	Z259.13 Z259.16	-	Z259.13 Z259.16	-	Engineered	-	-	Z259.13 Z259.16	-	Z259.13 Z259.16	-	-	2 FOS	2 FOS
Fall Protection Equipment (CSA Z259 Series, ANSI Z359.1, EN Series)	CSA	CSA/ANSI	CSA/ANSI EN	CSA	CSA	CSA	CSA	CSA	CSA	CSA	CSA	CSA	CSA	CSA	-	-

# Minimum Height Requirements

## Diagram A

Anchor point above user. (In this case 1m (3.28') above user's harness attachment point)  
(Preferred Option)

Free fall distance: 0.5m (1.64')

Fall factor =  $0.5/1.5 = 0.3$  ( $1.64/4.92 = 0.3$ )

## Diagram B

Anchor point at shoulder level.  
(Non-preferred option)

Free fall distance: 1.5m (4.92')

Fall factor =  $1.5/1.5 = 1.0$  ( $4.92/4.92 = 1.0$ )

## Diagram C

Anchor point at foot level.  
(To be avoided)

Free fall distance: 3.0m (9.84')

Fall factor =  $3.0/1.5 = 2.0$  ( $9.84/4.92 = 2.0$ )

**NOTE:** The lower human figure in each diagram indicates the position of the user at the end of the free fall. This is the point at which the energy absorber begins to deploy and should not be confused with the position the user would be in at the end of the arrest of the fall.

## KEY

F = Free fall distance

(Source BS 8437:2005)

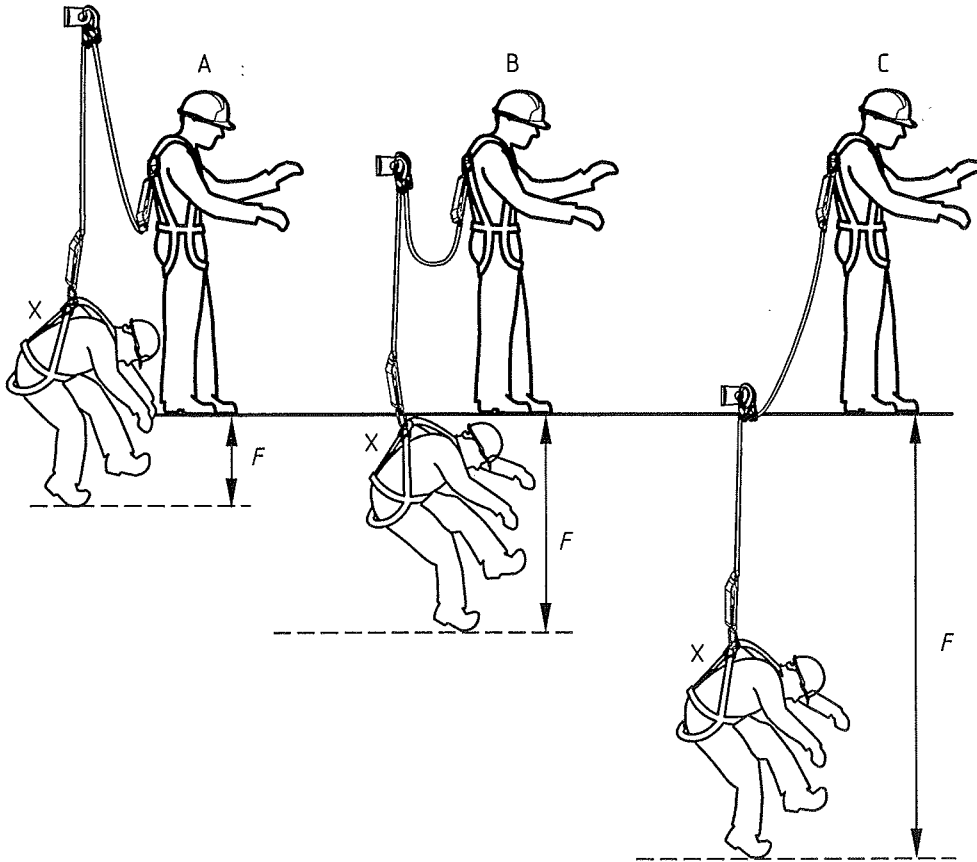

The above diagram shows three fall arrest situations. In each case the fall arrest system is based on a 1.5m (4.92') long energy absorbing lanyard and a distance between the attachment point on the user's harness and their feet of 1.5m (4'92"). The free fall distance is the vertical distance between the position of the user's feet immediately before the fall, and the position of the user's feet at the point at which the lanyard has become taut and started to arrest the fall. (Figure F in the diagram)

# Work at Height Rescue

Before commencing any work at height activity please ensure you are adequately trained and competent to carry out the task and able to use the safety equipment provided by your employer/building owner.

In situations where a work at height activity involves a “fall arrest” situation, it is a legal requirement for your employer/building owner to provide the anchorage point, rescue plan, policy, training and equipment to complete a rescue. It is not the responsibility of the emergency services to conduct such a rescue.

Should a rescue become necessary it is extremely important that the procedures detailed in the “roof permit to work,” rescue policy and plan are followed. Try to make contact with the casualty to establish if they are conscious or unconscious. If they are unconscious then time is of the essence.

Contact the emergency services and request an ambulance and fire/rescue support. Inform them of the exact address, location and site contact details of where you are working (This should be contained within the “permit to work”). Confirm that you are trained and competent to commence the rescue procedure.

Call your site contact and inform them of the situation and that you have already contacted the emergency services. Request they bring a competent First Aider to assist you at ground level by receiving the casualty. Before commencing the actual rescue, ensure that you are safely connected to an alternative suitable anchorage point (where possible). Ensure you work in “fall restraint” at all times whilst conducting the rescue procedure. Check you have all the Rescue Kit components as shown in the diagram below.



Before commencing the actual rescue, ensure that you are safely connected to an alternative suitable anchorage point (where possible). Ensure you work in “fall restraint” at all times whilst conducting the rescue procedure. **Check you have all the Rescue Kit components as shown in the diagram above.**

# Rescue Kit Operation

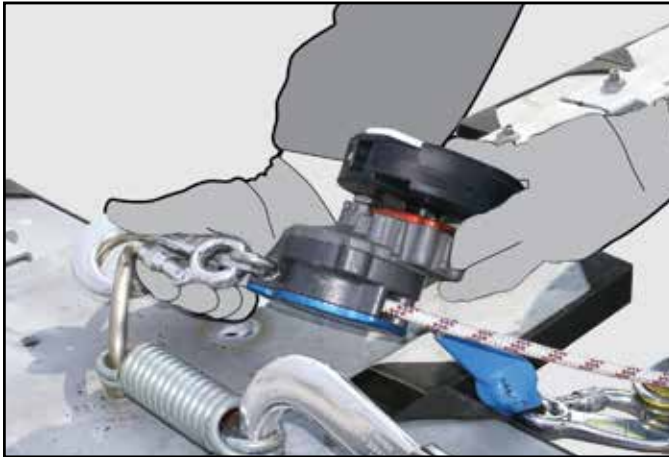

**a.** Connecting to the same or an alternative suitable anchorage point. Connect the Rescue Hub device using the Screw Gate Karabiner fitted directly to the Rescue Hub. Ensure the Screw Gate is tightened once connected to the anchorage point.

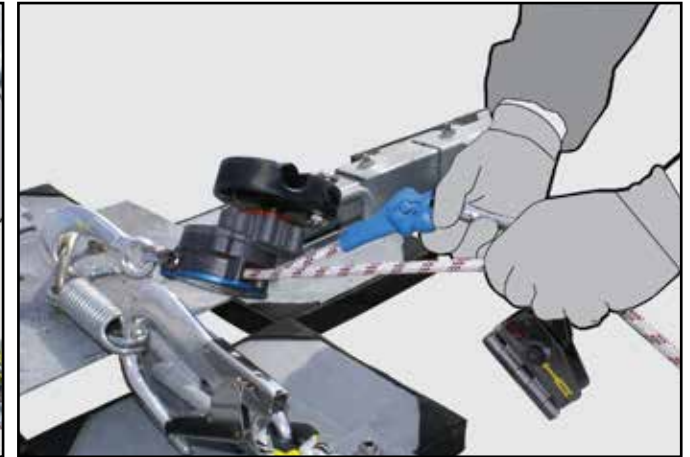
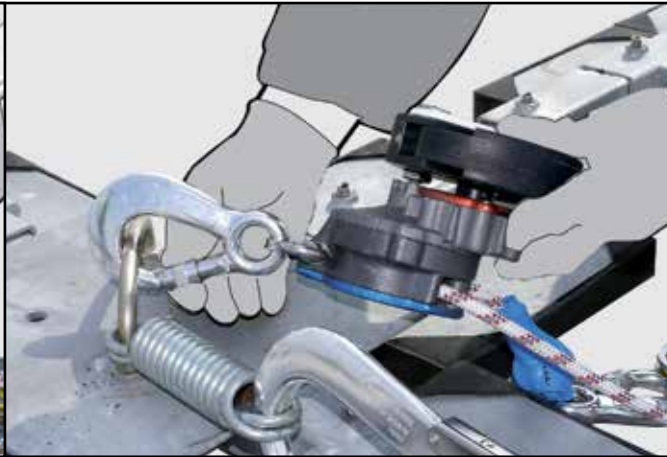

**b.** Pull the end of the Kernmantel Rope which has the Rescue Rope Grab attached. The Kernmantel Rope will start to feed out of the rescue bag and run through the Rescue Hub.

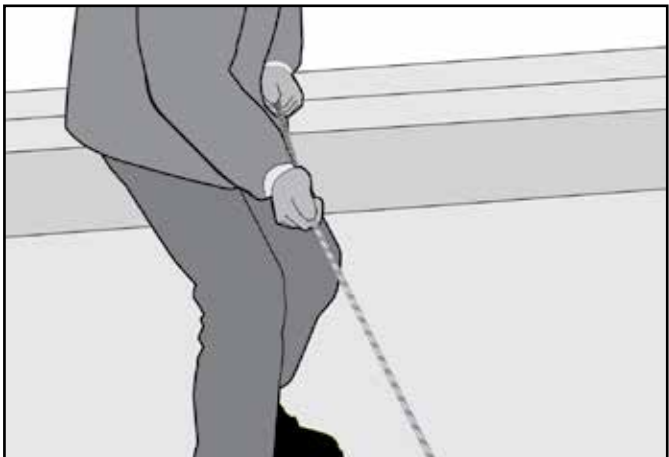

**c.** Start walking towards the area where the casualty has fallen whilst still holding the Rescue Rope Grab. When you reach this area, kneel down and continue to pull out sufficient rope to reach the "D" ring on the casualty's harness.

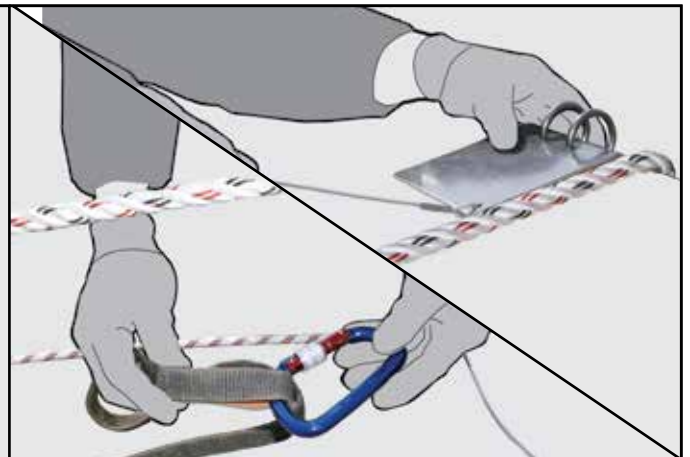
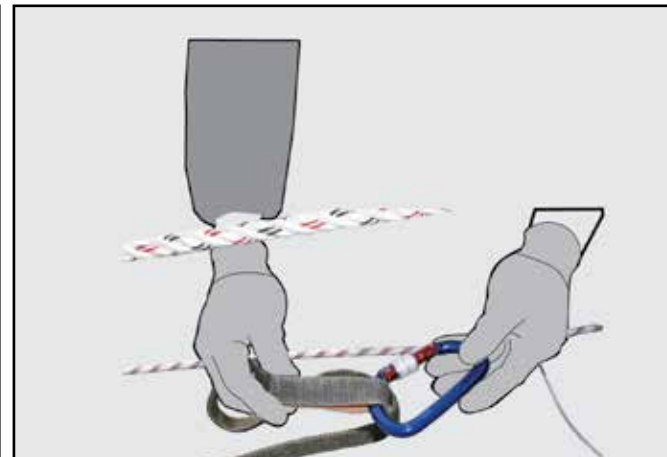

**d.** Ensure the Edge Protector is connected to the anchorage point, this may need to be extended in some cases via a webbing or rope sling. Place the Edge Protector over the edge ready for the rescue operation.



# Rescue Kit Operation

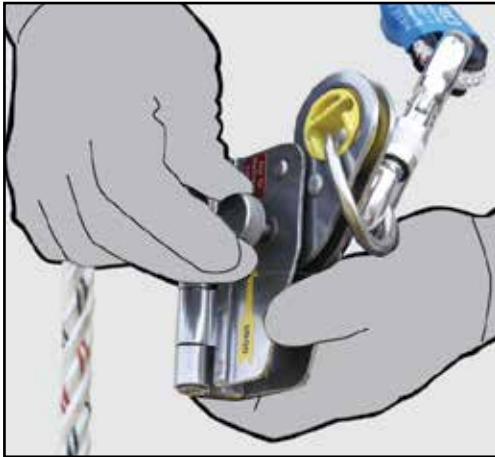

**e.** Whilst holding the Rescue Rope Grab unscrew the Screw Gate as shown above.



**f.** Turn the Rescue Rope Grab over and push the lever in an upwards direction.



**g.** The Rescue Rope Grab will now open.

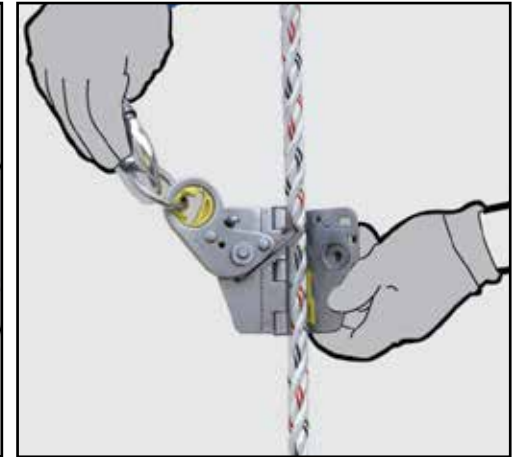

**h.** Ensure you have adopted a "fall restraint" position. Carefully lean over the leading edge and pass the open Rescue Rope Grab (with the arrow in the up direction) around the back of the casualty's rope. (cont)



**i.** (cont) Ensure the casualty's rope is correctly positioned inside the Rescue Rope Grab. Close the Rescue Rope Grab.

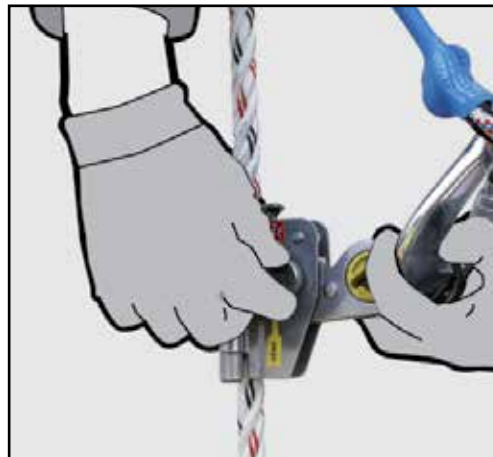

**j.** Once the Rescue Rope Grab is closed ensure the Screw Gate is then tightened into position.

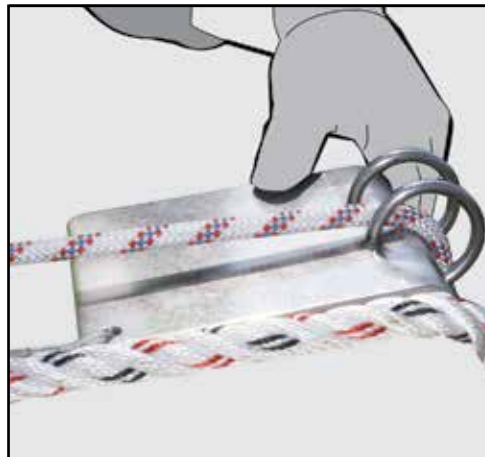

**k.** Position the Rescue Kernmantel Rope over the Edge Protector. Now carefully lower the Rescue Rope Grab down towards the casualty. The Rescue Rope Grab device will descend easily under gravity to the "D" ring of the casualty's harness.

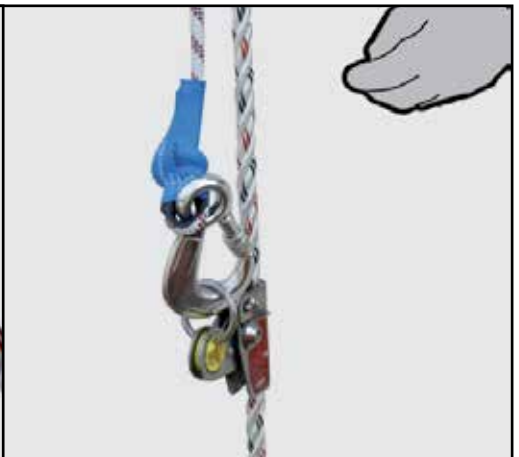

# Rescue Kit Operation

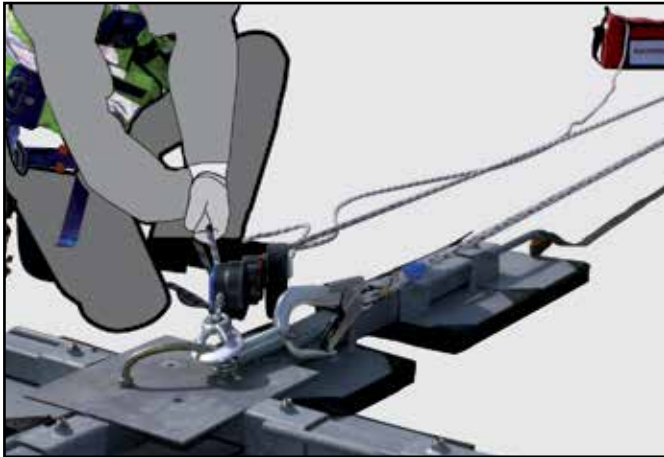

**l.** Return to the anchorage point where the Rescue Hub is connected. Pull any excess Kernmantle Rope through the Rescue Hub by pulling the free end of the rope which is stored in the bag.



**m.** Once the Rescue Hub Kernmantle Rope is taught, rotate & lower the locking pin so that it engages with the body of the hub. When in place correctly, the hub cannot turn.



**n.** Lift up the black handle as shown above.



**o.** With the black handle in position push in the silver ball bearing positioned in the centre of the white plate as shown above.



**p.** Now open the top third of the Rescue Hub and it will automatically lock into place.



**q.** Detach the pin.

# Rescue Kit Operation



**r.** Start winding the Rescue Hub in a clockwise direction so that the Kernmantel Rope passes through the hub. If the rope does not move through the hub, pull on the free end of the rope. Continue to wind until the casualty's primary rope becomes slack.

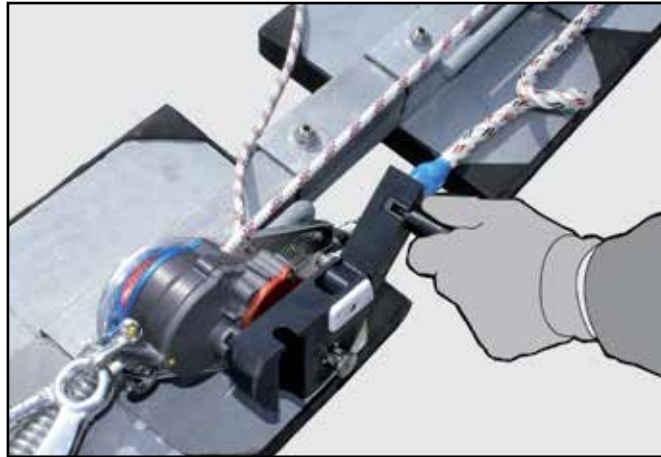

**s.** Once the casualty's primary rope is slack enough to detach their primary hook/karabiner from the anchorage point, stop winding and engage the locking pin by lifting, rotating & then lowering it. Ensure the pin is engaged against the body of the Rescue Hub. When in place correctly the Hub cannot turn.

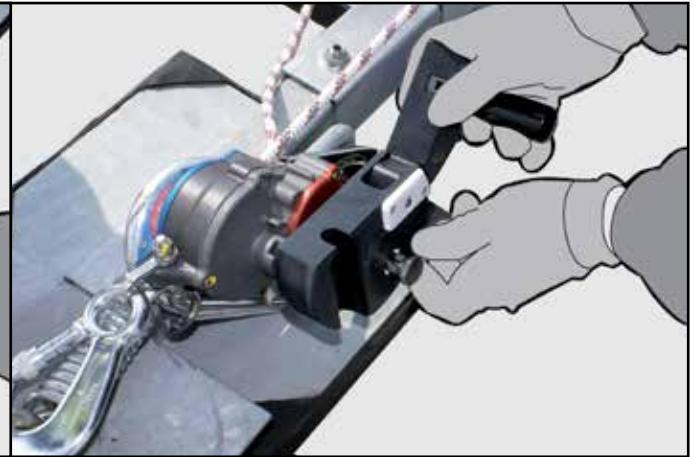

**t.** You can now remove the casualty's slack primary rope from the anchorage point as shown above.



**u.** Close the Rescue Hub by pressing in the silver ball bearing in the centre of the white plate. Once closed fold down the plastic handle.

# Rescue Kit Operation

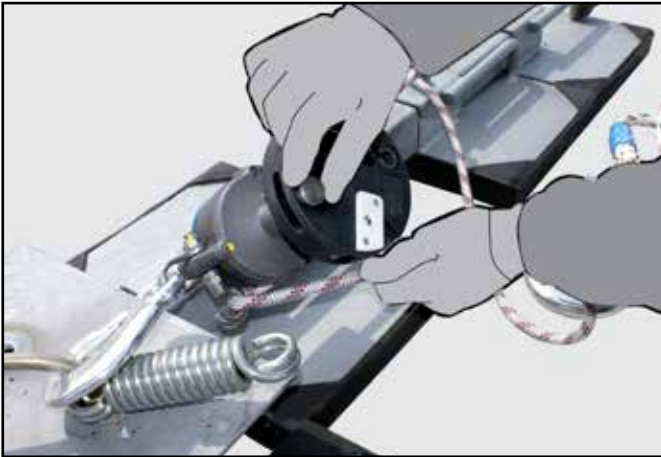

V. Pass the loose end of the Kernmantel Rope around the pig tail of the Rescue Hub. Hold the rope firmly in one hand. To take the load off the casualty, simply rotate and pull the Locking Pin upwards and rotate sufficiently so that the pin is disengaged from the Rescue Hub. Whilst holding the Kernmantel Rope you can move back towards the area where the casualty fell.

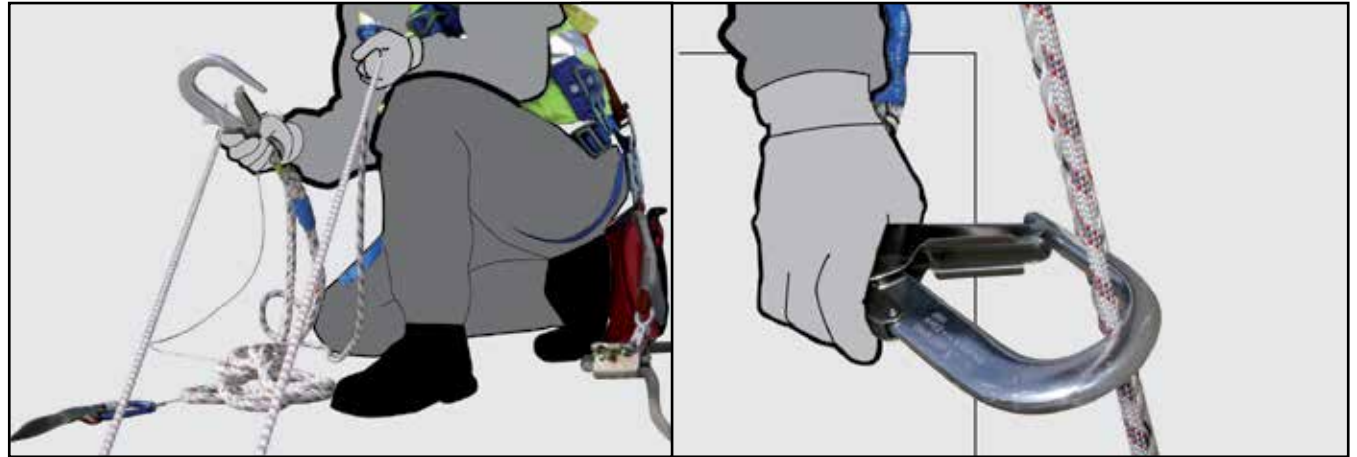

W. Once you are in a comfortable position and able to hold the casualty with one hand, take the casualty's primary rope which you previously disconnected from the anchorage point. When ready, carefully position yourself so you are able to attach this primary rope to the Rescue Hub Rope (Kernmantel Rope) as shown above. Ensure that you keep holding the Rescue Hub Kernmantel Rope at all times. Gradually lower the casualty's primary rope until the hook reaches the casualty's "D" ring. Ensure you are still holding the Rescue Hub Kernmantel Rope. You can now let the casualty's primary rope fall to the ground so that it can be used as a guy rope by those at ground level who are ready to assist/receive the casualty.

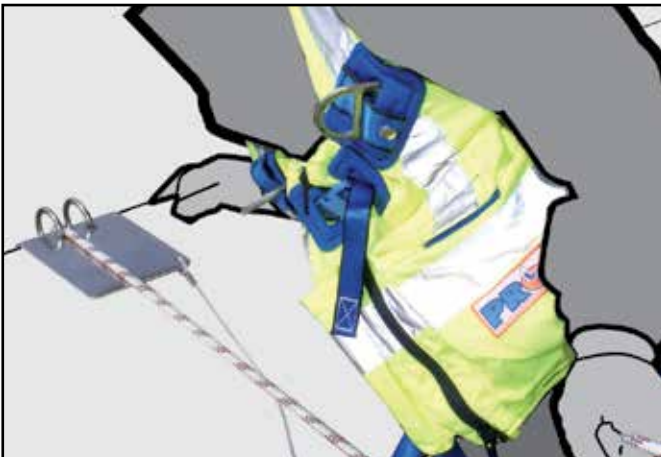

X. Begin to lower the casualty gradually, continually observing them and communicating with both the casualty and those at ground level who are receiving/assisting the casualty. The competent first aider must then follow the standard UK first aid guidance for the recovery of a person. The casualty must then be seen by the ambulance crew, even if they appear to have recovered.

# KeeLine Recertification

- Periodic inspections by a competent person are recommended by the manufacturer and required under Regulation 5 of the Workplace (Health Safety & Welfare) Regulations, BS EN 365 & BS 7883. The frequency will depend upon environment, location and usage, but should be at least every 12 months.
- Check structural connection of system.
- Walk the complete system and check the smooth running over all intermediate brackets and that the system still serves client's needs.
- Establish if any modifications or additional products are required to reflect any refurbishment or additional plant and equipment that has been installed and requires access.
- Inspect shock absorber.
- Inspect cable for damage / kinks / signs of wear.
- Check and tighten all visible / accessible fixings.
- Any galvanised components showing signs of corrosion, wire brush thoroughly and apply galvanised spray / paint as appropriate.
- If rusted significantly take digital photographs and include in inspection report.
- Pull test visible end fixings to concrete / brickwork / structure (where possible) 6kN - 15 secs.
- Re-tension cable if required to allow smooth operation of the system (where required).
- Clean entire cable run with white spirit.
- Any part of the installation or fixings that may need additional attention including shock absorber - take digital photographs and include in the inspection report.
- Any major components, other than nuts/ bolts/ washers etc, which may need replacing report to client and establish costings, so that if possible it can be repaired whilst on site.
- Check system plaque position & mark up to reflect date of the next required inspection. Establish if additional plaques are required due to any refurbishment work.



**Kee Safety Singapore Pte Ltd**  
38 Ang Mo Kio Industrial Park 2  
#01-03, Singapore 569511

Tel.: +65 6385 4166  
Email: [sgsales@keesafety.com](mailto:sgsales@keesafety.com)  
Website: [keesafety.sg](http://keesafety.sg)