

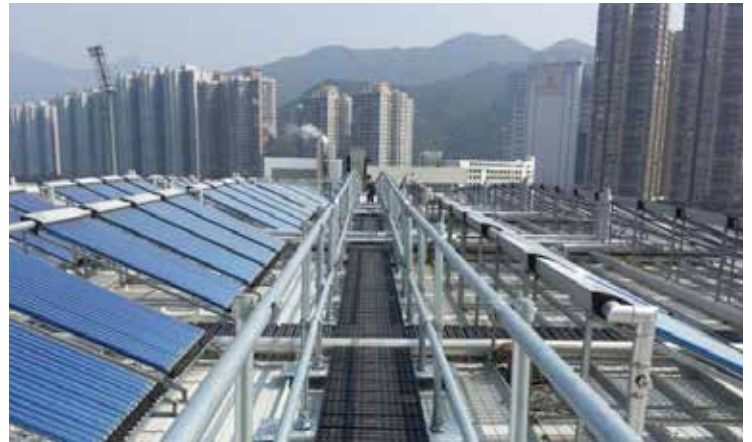

SEPARATING PEOPLE FROM HAZARDS

Fall Protection Solutions



- COMPREHENSIVE RANGE OF COLLECTIVE AND PERSONAL FALL PROTECTION SYSTEMS
- COMPLIANT WITH RELEVANT INTERNATIONAL STANDARDS
- GLOBAL AVAILABILITY
- DESIGN AND INSTALLATION SERVICE AVAILABLE

Why Safety Is Important

Health and safety is about preventing people from being harmed by work or becoming ill through work. Globally each year there are several hundred people killed at work and several hundred thousand are injured or suffer ill health.

The most common cause of absence due to sickness is from aches and pains such as back problems while globally falls from height is still one of the main causes of death. In the construction sector of the UK, USA, Canada & Singapore approximately one third of all fatalities are related to falls from height.

Health and safety law applies to all businesses however

small. It covers full-time and part-time employees, temporary or permanent, the self-employed as well as contractors and members of the public.

Legislators set out the general principles of health and safety law and guidance to ensure businesses are compliant. This legislation establishes duties employers have towards employees and members of the public, as well as what duties employees have to themselves and to others.

Failure to comply with health and safety law is an offence and can lead to prosecution of an individual, company or corporate entity.

Collective and Personal Fall Protection Solutions

Globally Kee Safety Group offers a complete range of height safety and health & safety solutions, all designed to cater for individual requirements and budgets. For example we can provide a simple one off service such as the **Supply Only** of a product or **Recertification** of an eyebolt, or offer you a complete service starting with an on-site **Survey** including drawings, photographs and budgeted system to determine your requirements, followed by **Design, Installation, annual Recertification** and staff **Training**.

When it comes to health & safety, especially specialised areas such as work at height, it is essential that you only use a competent company. Kee Safety's recruitment

within the construction and health & safety industries means we have a professionally qualified team of technicians, surveyors, installers, engineers and health & safety practitioners. The company is continually vetted by industry affiliations who consider every aspect of our performance including staff professionalism, products and services, environmental impact and health & safety record. Kee Safety is also involved with key industry bodies such as the HSE, CSA, ANSI, RIBA, RICS, IOSH, Construction Health & Safety Group, WAHSA and the BSIF. The company also represents the BSIF on the UK Advisory Committee for Roof Safety and the BSI as their principal expert on European Committees.



Why Safety Is Important

Kee Safety is able to offer clients the following fall protection services

WORK AT HEIGHT SITE SURVEY & REPORTS

Kee Safety's qualified surveyors are able to carry out professional site surveys to help companies comply with legislation and to determine the best solution for specific requirements.

Our Free Site Surveys are ideal for buildings with a small roof area and include a single page report, outlining our recommendations together with photographs, drawings and a full costing for the suggested solution.

Commissioned Surveys are ideal for large or multiple sites and can help to establish what work is required in order to prepare budgets and gain approval from management and/or the finance department. Following the survey(s), Kee Safety provides a comprehensive report including relevant legislation, description of the areas surveyed, digital photographs, layout drawings,



risk assessment of each area surveyed and a detailed cost analysis. A summary report is also produced, prioritising the suggested work for reference.

WORK AT HEIGHT DESIGN & INSTALLATION

Once a site survey has been completed or we have received site drawings/photographs, our Technical Department will prepare a detailed and cost effective solution for each situation. The recommended solution will include any applicable wind calculations and take into account the structural design of the building and the

likely loads applied by the solution and those using the system. The Contracts Department will then organise the complete installation including delivery, access, operatives and any additional works such as roofing/cladding repairs that may be required.

RECERTIFICATION

Once equipment has been installed it must be maintained and examined at least once a year as outlined in BS 7883 and BS EN 365. As part of its recertification service, Kee Safety's qualified engineers will not only assess roof safety equipment such as lifeline systems and guardrails, but will also inspect and certify all PPE used in conjunction with this equipment, including lanyards and harnesses and carry out individual training on the equipment provided.



SUPPLY ONLY PRODUCTS

There may be times when you wish to install a system yourself, or use your own contractors. When it comes to Supply Only, Kee Safety offers a range of products at extremely competitive prices with the added benefit of support and assistance from our experienced Technical

Department. Where relevant, site specific layout drawings and wind speed calculations are provided free of charge as is a complete O&M manual covering the assembly, installation and recertification requirements of the product.



Fall Protection Solutions

As a leading supplier of both Collective and Personal Fall Protection products we have a portfolio which can eliminate many of the unnecessary risks that are still taken every day by people working at heights.

This brochure is intended to provide an introductory overview of our range but if more technical information is required please contact our sales teams or partners for more detailed information.

Our market leading portfolio is available across the globe and encompasses freestanding guardrail, lifelines, anchor points and a selection of fall protection accessories to provide a one stop solution. In fact for working at height, safety is Kee.



Free Standing Guardrail

Kee Safety offers a range of free standing guardrail products to cater for a number of differing scenarios.



Free standing guardrail made from galvanised steel.



Free standing guardrail made from lightweight aluminium.



Free standing, foldable guardrail to maintain building aesthetics. Made from galvanised steel or with aluminium top and mid rails.



Free standing guardrail without the need for a counterbalance arm designed for use in confined spaces

Free Standing Guardrail

Keep®
Guard

Keep Safety's free standing guardrail, **KEEGUARD**, has been designed specifically to provide permanent edge protection for areas where regular access for maintenance and inspection is required.

The range has been developed to suit specific requirements and includes the standard design with vertical legs, raked and radiused systems, as well as a collapsible version for areas where a more discreet form of protection is required.

Each system is based on a simple cantilevered design which provides unrivalled strength, stability and safety and overcomes the problem of having to drill and puncture the roof membrane which can lead to potential water damage and noise disturbance during installation.

The systems comprise galvanised tubing joined together using the "**KEE KLAMP**" method of connection and can be supplied in steel or aluminium and powder coated if required. Counterweights are made from 100% recycled PVC and are designed for ease of handling and speed of installation.

All base feet have fluted rubber matting bonded to the underside in order to protect the roof membrane. Additional protection may be required depending on the roof membrane. In these instances it is recommended that sacrificial pads are placed under components which come into contact with the roof membrane.

All free standing guardrail systems have been tested to the relevant global standards.

Where space constraints dictate that a counter balance system can't be employed, Keep Safety is able to offer **KEEGUARD PREMIUM** as the solution. A uniquely designed two part PVC weight allows a rail system to be installed around typical obstructions such as air conditioning units or solar panels. **KEEGUARD PREMIUM** weights can also be incorporated into a standard **KEEGUARD** system to by-pass major obstacles.



Why Choose a KeeGuard System?

By using a correctly installed and tested **KEEGUARD** system you can ensure the safety of anyone who has access onto a flat roof. **KEEGUARD** is a fully tested and approved guardrail system which means no specific training or equipment is required by operatives who access a roof area. The system is supplied in modular kit format, with a minimum number of assemblies so is quick and easy to install.

Safety and Versatility

- Suitable for use on Concrete, Asphalt, PVC Membrane and Felt roof surfaces.
- Designed to work on roofs up to a 10° pitch.
- Design load of 300 N/m applied horizontally along the top rail.
- Integral Toe board fittings.
- Elastomer pads under the weights prevent damage to the roof surface.
- Non-slip rubber pads fitted under the uprights.

Durability and Simplicity

- Corrosion resistant—all iron fittings are galvanised to EN ISO 1461
- Fittings use case hardened steel setscrews with **KEE KOAT** protection
- Minimal components for ease of installation
- Open cup fitting for quick installation
- No penetration of the roof membrane
- No welding, threading or bolting on site
- Installations can be customised to cope with ladder access and any other roof obstructions
- Modular design permits reconfiguration on site if needed
- Three types of upright available



Compliance

- EN 13374 Class A
- EN ISO 14122 Part 3
- BS 13700
- NF E85-003
- EN 1991-1-4
- BS 6399: Part 2 Code of Practice for Wind Load
- OSHA Reg 29 CFR 1910.23 (E) (1); (E) (3)(IV).
- OSHA Reg 29 CFR 1926.501 (b) (1); (b) (2) (ii)
- OSHA Reg 29 CFR 1926.502 (B) (1) - (B) (14)
- Canadian National Building Code 4.1.10.1 (1) (e), 4.1.10.1 (2), 4.1.10.1 (4)
- Ontario Building Code Section 4.1.10.1 (1) (b), 4.1.10.1 (2), 4.1.10.1 (4)

KeeGuard Upright Options

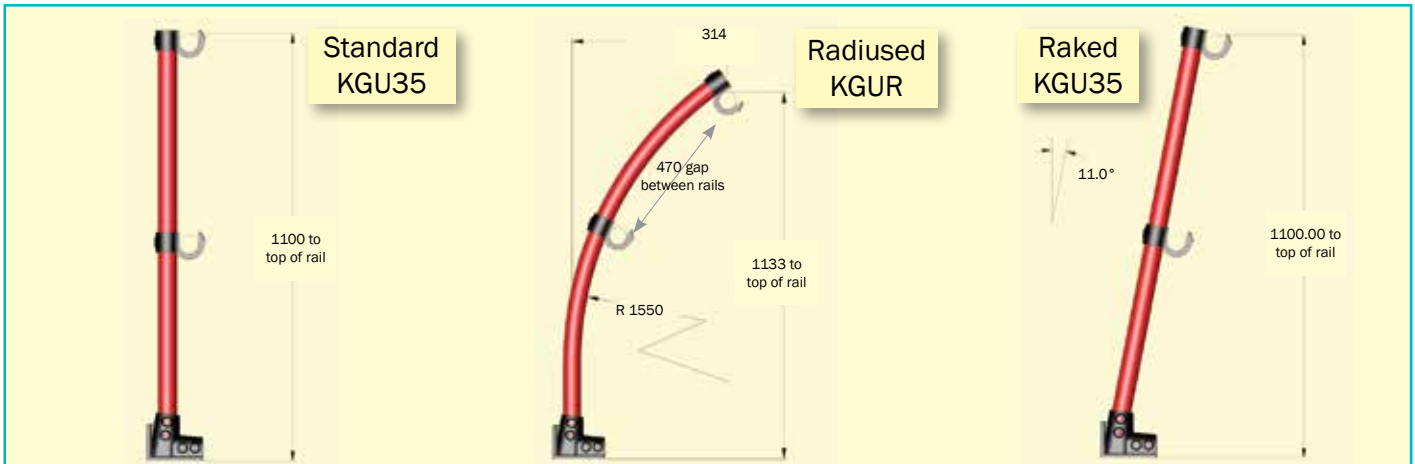

Recycled, Easy to Handle PVC Base Weights

The recycled PVC weights used with **KEEGUARD** bring a number of advantages to the system and particularly make installation quicker and easier thus saving both time and money.

- 13.5kg per weight
- Size: 460 x 500 x 85mm
- Carrying handles moulded into the design
- Available in black as standard. Other colours available by request at extra cost.
- Moulded surface to improve grip
- Optional covers for counterweight tube available to minimise trip hazards
- Environmentally friendly
- Made from 100% recycled material in the EU

NB To protect asphalt roofs from damage it is recommended that Elastomer pads (available from Kee Safety) are placed under all counterweights and uprights.



Essential Kee Klamp Fittings used to complete a KeeGuard System

<p>14-8</p>	<p>15-8</p>	<p>19-8</p>	<p>61-8</p>	<p>77-8</p>
<p>Type 14-8 Straight Coupling is used to connect lengths of tube.</p>	<p>Type 15-8 Elbow is used for 'D' Returns and 90° corners.</p>	<p>Type 19-8 can be used for variable angles and to accommodate slope irregularities.</p>	<p>Type 61-8 Flange is used for wall attachments.</p>	<p>Type 77-8 Plastic Plug is used to cap open tube ends.</p>



Aluminium Free Standing Guardrail

KEEGUARD LITE is the Aluminium free standing guardrail solution from Kee Safety.

Embracing all the product benefits of **KEEGUARD**, this aluminium version incorporates aluminium uprights and tube but maintains its stability by using a steel base fitting, steel counterbalance arm and a larger 25Kg weight.

The standard bay size for **KEEGUARD LITE** when compliant to EN 13374 is 3m. However, in order to comply with EN ISO 14122-3 the maximum bay size is 2.4m

Features

- Aluminium rails & uprights
- Recycled 25Kg PVC weights
- 42.4mm OD tube for horizontal rails & 48.3mm OD tube for vertical uprights
- Available for standard, raked and raked uprights

Benefits

- Safe, reliable and versatile collective fall protection solution
- Does not penetrate the roof fabric
- Lightweight & corrosion resistant
- Minimal long term maintenance keeps on-going costs down.



Free Standing Folding Roof Edge Protection

KeeGuard[®]
Foldshield

When collective protection is the preferred method of providing a safe working environment but it is not desirable to have railings permanently visible on the roofline of a building, **KEEGUARD FOLDSHIELD** provides an ideal solution.

Designed for use on slopes up to 10° the system is suitable for use on asphalt, concrete, mineral felt or PVC sheet covered roofs and complies with the requirements of EN 13374.

Using a hinged version, see below, of the standard **KEEGUARD** base fitting the guardrail can easily be lifted into place when work is in progress and then quickly folded back down when finished.



KEEGUARD FOLDSHIELD offers all the flexibility of standard **KEEGUARD** allowing continuous runs, fixed ends, corners, changes in direction etc. or can be installed in 6m sections with 'D' returns (as illustrated) to enable it to be folded quickly and simply. A simple locking pin is all that needs to be removed from the base foot to allow it to pivot.

Two people can easily raise or fold down a standard section (max. length 6.4m) of guardrail. To minimise the weight of a section **KEEGUARD FOLDSHIELD** is also available in a configuration to allow aluminium mid and top rails. With a maximum bay size of 2 meters it can be used in both restrained and unrestrained applications.

In order to use the folding base in a restrained situation an additional support prop is added to the up-rights at six metre intervals to allow sufficient room for the fitting to pivot. A minimum roof up-stand of 250mm is required.



Features

- Folds down when not in use
- Base fitting can only pivot in one direction
- System can be raised and lowered in sections

Benefits

- Does not spoil building aesthetics
- No possibility of the guardrail folding the wrong way
- Saves time & increases flexibility



Free Standing Guardrail Without a Counter-Balance Arm

The **KEEGUARD PREMIUM** system has been designed for use where space constraints prohibit the use of a counterbalance arm. A two part interlocking recycled PVC base weight gives the system sufficient stability to meet the requirements of EN 13374:2013 and provide a compliant guardrail to allow safe roof access.

KEEGUARD PREMIUM is suitable for both temporary and permanent applications on roofs of up to 10° pitch.

The weights can be split to allow carrying by a single person or can easily be carried complete by two workers using the comfortable moulded handles. A base weight measures 550mm square, stands 161mm high and weighs a minimum of 40kg.

The maximum bay size is 3m with a 2.2m return required at each end of an open ended system.

The design of the base weights also allows for toe-boards to be easily slotted into place if required.

In addition to rooftop applications, KEEGUARD PREMIUM can also be used for temporary worker protection in ground based situations.



Compliance

- EN 13374:2013 Class A
- OSHA 1926.502, 1910.23
- BS 13700



Features

- No counterbalance arm
- Recycled two part PVC weight
- Non-penetrative system
- Toe board slots
- Works in combination with standard KEEGUARD system
- Weights are stackable for easy storage

Benefits

- Smaller footprint than counterweighted systems
- No waterproofing required
- Quick Assembly and Dismantling

Guardrail Kit for Ladder Access Points

KeeGuard[®]
Ladder Kit



KeeGuard Ladder Kit is designed to provide a permanently fixed guardrail either side of an existing fixed ladder. It incorporates a self closing swing gate to ensure a continuous barrier is in place around the roof surface and the ladder access point is guarded. The product is compliant with the requirements of EN 14122-4. The guardrail is attached back to the ladder by means of a fitting which can attach to both flat or tubular stringers up to 75mm width or diameter. There is no need to mechanically fix the system to the buildings' structure or through the roof membrane.



Compliance

- EN ISO 14122-4

Features

- Free standing guardrail 1.5m either side of the ladder access point
- Reversible Self closing gate
- Galvanised steel finish
- Simple retro-fit installation

Benefits

- Guardrail prevents falls down the side of the ladder
- Durable and corrosion resistant
- No penetration of the roof surface or building structure.



KeeGuard Roof Edge Protection for Cladded Roofs

KEEGUARD can also provide a collective protection solution for standing seam and metal profile roofs up to a 45° pitch. The **KEEGUARD TOPFIX** system has multiple fixing centres on the base plate to allow for installation on a wide range of the most popular roof types.

The base plates are fixed onto standing seam roofs by non-penetrative two-part clamps whereas rivets and butyl sealing strip are used on metal profile roofs. The fixing centres for standing seam roofs are: 305, 400 & 500mm.

The fixing centres for trapezoidal profile roof panels are: 310, 333, 400 & 500mm.

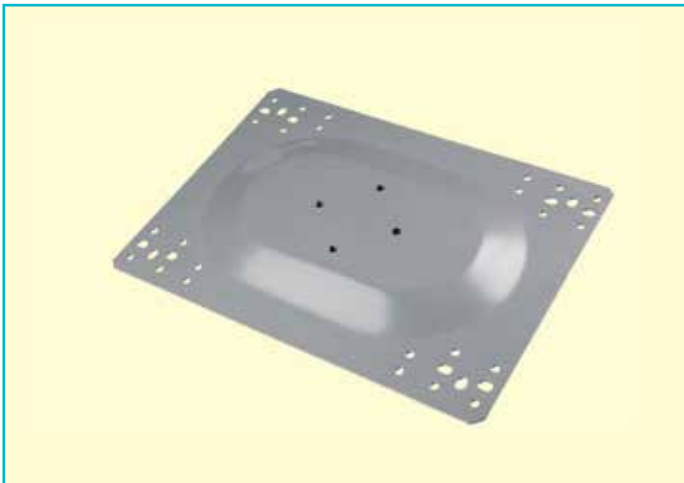

The base plate provides the support for the standard upright which allows for 0-11° vertical adjustment and the arrangement of the fixing holes allows the system to be fitted to a wide range of profile sheet centres. The horizontal rails are then simply fitted into the open saddle fittings to provide a complete collective solution.

KEEGUARD TOPFIX is available in galvanised steel but additionally an aluminium version, **KEEGUARD TOPFIX LITE** is also available.

For a **KEEGUARD TOPFIX** installation to comply with EN 13374 the normal bay size is 3m but to comply with EN ISO 14122-3 the maximum bay size is 2.5m with the end bays being 1.75m. For **KEEGUARD TOPFIX LITE** to comply with EN 13374 the normal bay size is 3m, with additional bracing required every 4.5m. However, in order to comply with EN ISO 14122-3, the maximum bay size is 1.5m with additional bracing required every 4.5m.

Compliance

- EN ISO 14122 -3
- EN 13374:2013 Class A

Features

- Modular system
- Galvanised or Aluminium options
- Suitable for a wide range of roof types
- Compliant with European standards

Benefits

- A collective protection solution
- Easy specification
- Fast installation, saving time and money
- Non-penetrative on standing seam roofs
- Watertight fixings for metal profile roofs maintain the roof's integrity

Structurally Mounted Roof Edge Protection Modules



KEE MODULES is a range of pre-designed upright assemblies to enable the quick specification and installation of EN14122-3 compliant structurally mounted roof edge protection.

Available in size 7 (42.4mm) and size 8 (48.3mm) galvanised steel or aluminium. The standard configurations offer side fixing, top fixing or a fitting to enable mounting underneath aluminium copings.

Handrails can be in line or off set, with single or double rails and the uprights can be supplied straight, inclined or radiused.

Compliance

- EN ISO 14122–3

Kee Modules® side fix mounted, handrail tube in-line

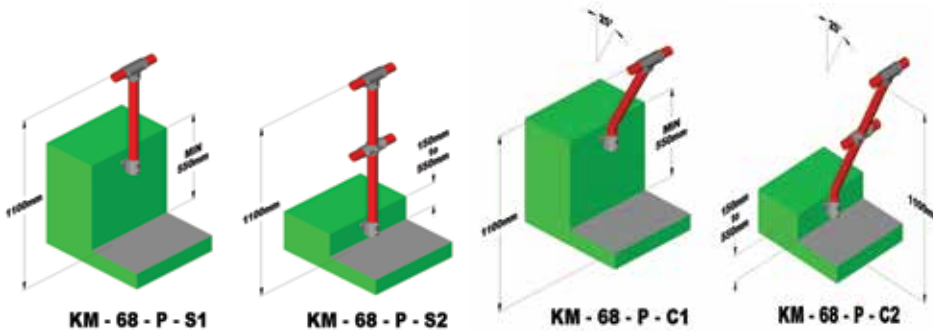

Features

- Galvanised steel or aluminium
- Multiple variations
- Adaptable to roof variations
- No threading, welding or riveting required

Kee Modules® for mounting under aluminium coping, handrail off-set or in-line

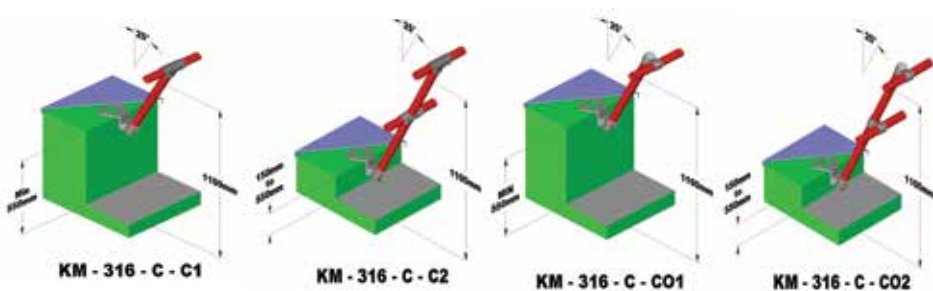

Benefits

- Pre-assembled uprights for quicker installation
- No hot work permits required
- Adjustable on site
- Assured design loads
- Fittings don't damage any protective coatings on the tube

Kee Modules® top fix mounted, handrail tube off-set

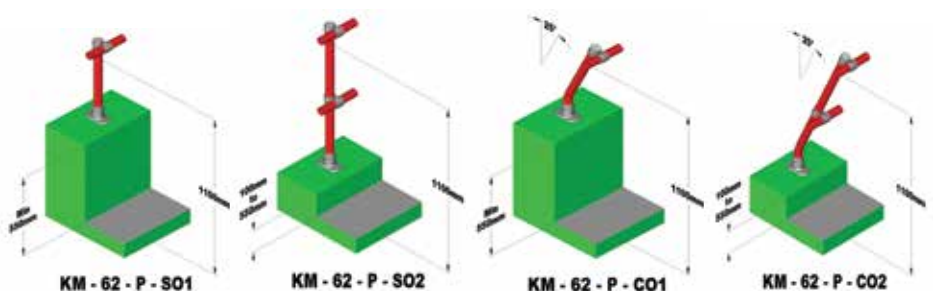



The Safety Solution for Skylight Fall Protection

This innovative product provides protection for personnel accessing near to fragile rooflights whilst carrying out maintenance or inspections on a flat roof. The **KEE DOME** is a modular system designed specifically to prevent falls through rooflights.

KEE KLAMP fittings and standard length tubes are used to construct a rigid frame which is positioned in recycled PVC bases which lock the posts into position around the perimeter of the rooflight.



Compliance

- EN ISO 14122-3

Features

- Modular System
- Recycled PVC base feet
- Use 48.3mm o/d tube (size 8)
- Suitable for use on all roof surfaces with a maximum pitch of 3°

Benefits

- Quick and easy to install
- Designed as a permanent solution
- Collective protection solution



Kee® Dome Mini

Where building aesthetics are a concern, the **KEE DOME MINI** provides a less obtrusive solution due to its low height. This product can be used on rooflights from 1.2m x 1.2m up to 1.8m x 1.8m. This version features smaller recycled PVC bases, tubes (33.7mm o/d) and fittings.



The Safety Solution for Roof Light Protection

**Kee®
Cover**

KEE COVER has been specifically designed to provide a robust effective solution for covering unprotected roof lights on metal profile roofs without blocking out the light they are supposed to letting into a building. **KEE COVER** consists of a strong mesh panel mounted onto a metal frame. The standard mesh panels are 2m long and 1m wide, but extension panels are available which are either 2m or 1m long x 1m wide. The metal frame is made from **KEE KLAMP** fittings and Size 5 (26.9mm outer diameter) tube.

KEE COVER is available in two formats, one which fixes virtually flat to the roof surface (as shown top right) and one which is raised above the skylight which is mounted on small legs (see image to right) to give a greater distance between the mesh panel and the roof light. In the event of a fall this would help ensure the roof light is not damaged when the **KEE COVER** absorbs the impact.



Testing & Compliance

KEE COVER has been tested to the Class B criteria and loadings required in the ACR Red Book Test for Non-Fragility of Roof Assemblies. The test involves a 45Kg (100lbs) weight free falling from a distance of 1.2m (4') to reach a maximum velocity. Class B rated products ensure the drop mass is retained but there is permitted some damage to the roof light.

An additional 1200 joule test has been carried out to BS EN 1873. This requires a 50Kg (110lbs) mass to be dropped from 2.4m (7.9') and be retained by the **KEE COVER** whilst ensuring there are no gaps larger than 300mm within the mesh.

KEE COVER meets both of these test criteria.



Features

- Highly portable component based system which is easily transported the roof top
- All components and mesh panels are hot dip galvanised for enhanced durability
- Mesh panels do not block out light, keeping the building illuminated
- Extension panels allow for extended width and lengths to be covered, ensuring the roof surface is safe.
- Easily fitted keeping installation costs down.
- Metal frame and panels will not go brittle thus delivering longevity for the installation
- Variable height facility allows for use over different shaped roof lights.
- Tube can be colour coated if greater visibility is required.



Personal Protection Solutions

Kee Safety provides a range of personal protection solutions designed to offer enhanced personal safety when working at heights; each of these products is tested and approved by the relevant bodies to comply with the required standards.

As we offer a wide range of solutions, our products can be selected to suit numerous applications with permanent, temporary, fixed or non-penetrative options.



WEIGHTANKA EN795 Class E deadweight anchor for up to 2 users.

ACCESSANKA provides an EN795 Class B anchor point for rope access.

WIREANKA EN795 Class E supports for an EN795 Class C flexible wire system for multiple users. Designed for use where the installation of collective protection or permanent personal anchor devices is not viable or desirable (page 17).



EN795 Type C horizontal flexible life line for roofs, for structures or for through fixing with **POSTANKA** (page 20).



A modular system of walkways and steps which provides a safe, anti-slip, level walking surface for anyone who needs to access a roof. Multiple fixing options for flat, barrel and sloping roofs. Complies with EN 516:2006 (page 29).

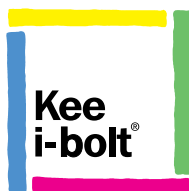

The **KEE I-BOLT** range offers a comprehensive selection of EN 795 Class A1 safety anchors and fixing options for concrete, brick and steelwork.

RINGANKA is a range of eyebolts for permanent fixing.

KEYANKA is a removable eyebolt which is unobtrusive where visual presentation is important (page 30).

Safety Solutions for a Portable Deadweight Anchor

Kee®
Anchor

The **KEE ANCHOR** range of products comprises:

- **WEIGHTANKA** – portable deadweight anchor
- **ACCESSANKA** – portable deadweight anchor system for rope access
- **WIREANKA** – deadweight anchor system with flexible horizontal life line.



Weightanka®

A KEE SAFETY PRODUCT

Deadweight Anchor

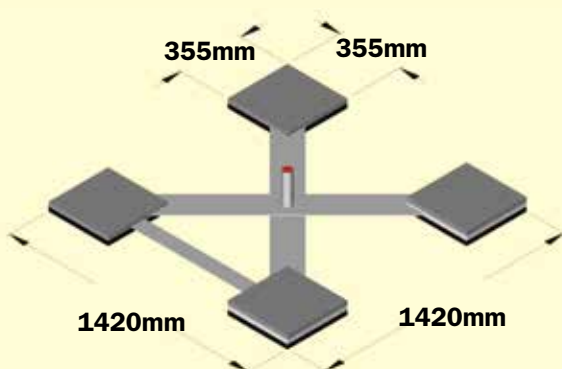

WEIGHTANKA is a mobile, deadweight anchor device for use on roofs of up to 5 degrees pitch, where the absence of guardrails or permanent anchor devices would otherwise preclude safe means of access. **WEIGHTANKA** is the first Class 'E' anchor device to be approved for use on all roof surfaces when wet and also for use downhill on metal clad roofs (subject to the addition of two extra weights). **WEIGHTANKA** utilises a central pedestal (attachment point) which raises the height at which the arrest force is applied, thus reducing the distance the anchor device moves during a fall arrest event.

A basic system weighs only 250Kg and uses individual, smaller components, with no single item weighing more than 25Kg. The modular construction makes it a very practical and convenient option, easy to lift and carry to and from the point of use.

Features

- Does not penetrate the roof surface
- Base layer weights fully encased in rubber moulding
- Raised central pedestal reduces the distance of travel during a fall arrest event
- Galvanised to BS EN ISO 1461
- Conforms to CLASS E EN 795, BS 7883 & ISO 14567
- CE Approved to PPE Directive

Benefits

- System for up to two users for restraint
- Rubber moulded base layer weights prevent rubber pads 'peeling' at the edges
- With the correct model it can be used on any of the following roof surfaces in WET or DRY conditions:

Single Ply Membrane	Asphalt
Steel Cladding	Concrete
Stone Chippings (Brushed)	Mineral Felt
- Can be used on roofs up to 5° pitch
- Easy to assemble, minimal amount of components and no need for extra tools.

ACCESSANKA is designed as an accessory to **WEIGHTANKA** to provide a portable anchor device for rope access workers, allowing them to work safely in accordance with BS 7985, the 'Code of Practice for the Use of Rope Access Methods for Industrial Purposes'. When correctly installed, the system is extremely stable and will not migrate across the roof surface either in normal use or when arresting the fall of both a worker and a rescuer up to a 200Kg limit.

ACCESSANKA has been designed for easy transportation and installation with no part over 25Kg or 2 metres.

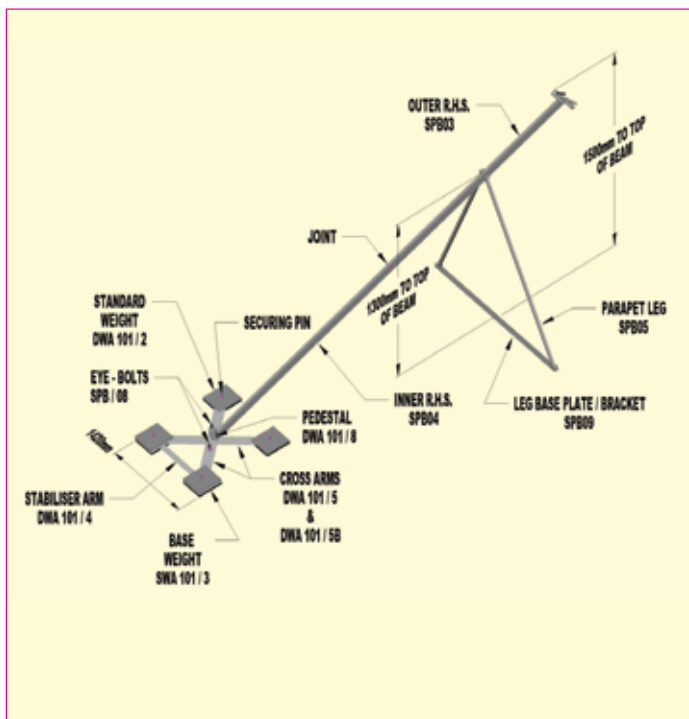

Features

- Does not penetrate the roof surface
- Self contained portable anchor device
- Separate anchor points for the working line and back up line
- Modular construction
- Internally force balanced system allows the assembly to remain static, even when arresting the fall of both worker and rescuer
- Conforms to CLASS B EN 795, BS 7883 & ISO 14567
- CE Approved to PPE Directive

Benefits

- Requires no attachment to structural members
- Easily moved across roof surface, removing need for multiple attachment points
- Rope lines held away from edge of building reducing risk of abrasion
- Provides full fall arrest protection before approaching edge
- Aluminium, galvanised and rubber coated parts requiring minimum maintenance.

Deadweight Anchor System with Flexible Horizontal Life Line

Wireanka[®]

A KEE SAFETY PRODUCT

WIREANKA is a system of deadweight anchor devices and horizontal flexible safety lines to EN 795. It is intended for use on flat roofs, in temporary situations, or where it is preferable that penetration of the roof surface be avoided.

For up to two users in fall arrest and multiple users in restraint (dependant on configuration).

To be classified as restraint, the position of the **WIREANKA** and the length of the lanyard must ensure it is not possible to approach within 500mm of a roof edge or other opening.



Features

- Does not penetrate the roof surface
- Base layer weights fully encased in rubber moulding
- Galvanised to BS EN ISO 1461

Benefits

- Suitable for use on any premises where disruption of day-to-day business operations by opening the roof is to be avoided
- With the correct model it can be used on any of the following roof surfaces in WET or DRY conditions:

Single Ply Membrane	Asphalt
Steel Cladding	Concrete
Stone Chippings (Brushed)	Mineral Felt
- Rubber moulded base layer weights prevent rubber pads 'peeling' at the edges.

Minimum Edge Distances and Minimum Free Fall Distances Relative to the Span

Fall Arrest Systems

Maximum span (m) between anchors	5	6	8	10	12	15
Minimum fall distance (m)	5.2	5.4	5.8	6.2	6.6	7.2
Minimum distance from edge of fall hazard (m)	2.5	2.5	3.0	3.0	4.0	4.0

Restraint Only Systems

Maximum span (m) between anchors	5	6	8	10	12	15
Minimum distance from edge of fall hazard (m)	2.5	2.5	2.5	2.5	Consult our Technical Department	



The **KEELINE** horizontal lifeline system is designed to provide safe access to any area of a roof by allowing workers to be permanently attached to the line at all times and be able to freely move around the roof surface. The system utilises 8mm grade 316 stainless steel wire and allow spans of up to 12m between posts and can be utilised by up to three users at any one time.



The **KEELINE** system incorporates an inline shock absorber that minimises loads applied to both the user and the building in event of a fall. The design has been configured and tested for use on a variety of roof types e.g. standing seam, membrane, metal profile using either “top fix” anchors or a “through fix” anchor (**POSTANKA**) where fixing to the main building structure is preferred. Equally, **KEELINE** is available for mounting directly to concrete, steel, brick or stonework in either horizontal or overhead applications.

KEELINE has been tested and conforms to the requirements of EN795 2012, CEN TS 16415:2013, ANSI Z359 and CSA Z259.

KeeLine® for Roofs



KEELINE now incorporates a redesigned post and base plate for use on membrane roofs. The new design will allow easier and quicker installation but still utilises the same range of brackets as the options for tiled, standing seam and metal profile roofs.

Upright Post for Membrane Roofs

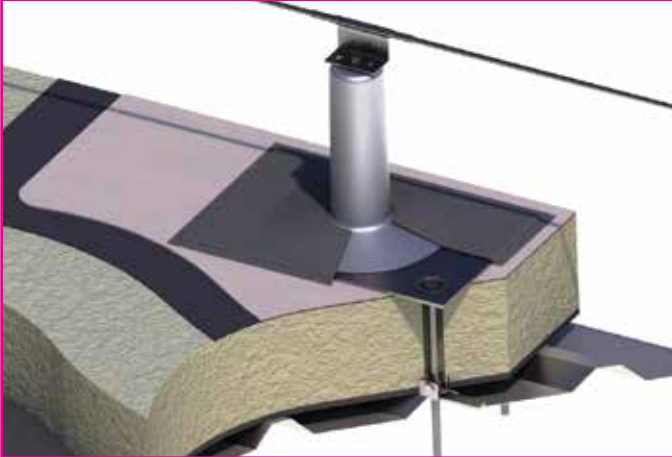

Upright Posts for Tiled Roofs

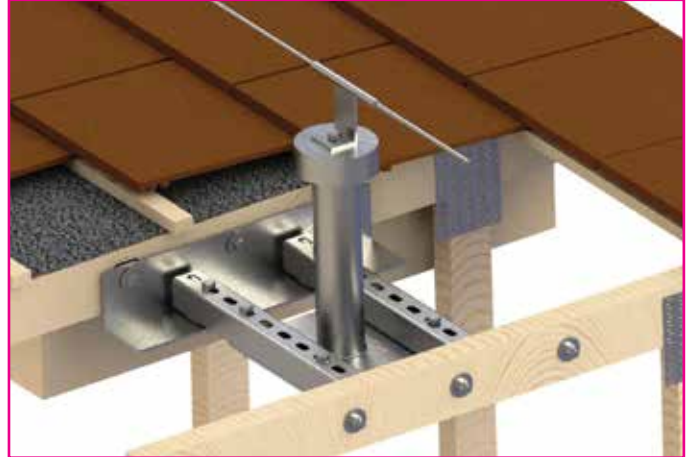

Upright Post for Standing Seam Roofs



Upright Posts for Profiled Sheet Roofs



KeeLine® Brackets for both Roofs & Structures

Intermediate Bracket

One-piece bracket for intermediate supports



Corner Bracket 90°

Accommodates internal or external bends



Corner Bracket 45°

Accommodates internal or external bends



KeeLine® Brackets for Structures Only

Extremity Bracket



Structural Corner



KeeLine® Universal Components

Wire



8mm dia 7x7 IWRC Gr.
316 Stainless Steel.
Available cut to length or
1000m reels.

Absorber

Used at both ends
of the system,
minimises loads
on structure to
below 10 kN.



Tension Indicator



Used at start of system
(or both ends for systems
over 150m).
Indicates when system is
correctly tensioned.
Available Swaged or
Swageless.

KeeLine® Traveller

Allows user to attach at any
point on system.
No moving parts.
Passes corners and
intermediates without
needing to detach from the
system.



Swage End Fitting



Used to terminate system.
Available Swaged or
Swageless.

KeeLine® Overhead Unique Component

KeeLine Overhead Traveller



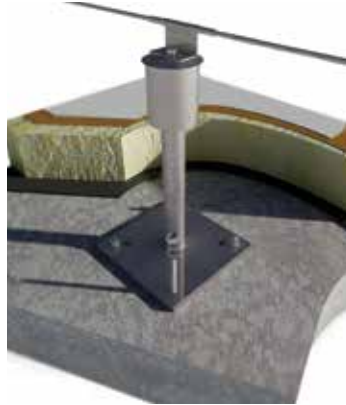

Kee Safety's **POSTANKA** range of fabricated, hot dipped galvanised anchors are designed using a standard calculation program to the requirements of EN 795 Class A2 or OSHA's 5000 lbs (22.2kN) requirement.

Used where it is preferable to mount directly to a buildings structure, e.g. on traditional sloping roofs or onto concrete roof decks, for example on green roofs.

POSTANKA anchors are available in standard sizes but are more typically designed to suit customer's specific application.

POSTANKA anchors are available in two styles.

Type 3 Postanka



Designed to clamp around either suitable wooden or steel beams and features a solid adjustable height pedestal.

Type 6 Postanka



A solid central pedestal welded to a 15mm thick base plate.

Available with multiple fixing options

As standard, **POSTANKA** anchors are tapped to accept the **KEELINE** system or alternatively for use with Kee Safety's **RINGANKA** eyebolt range to produce single point anchor points for fall protection or rope access.

Weather caps are also available.

As the **POSTANKA** range can be designed to suit a particular application, anchors can be produced for mounting other products for example **KEE WALK**.





- Higher pre-tension than standard **KEELINE** systems reduces line sag and cable deflection
- Supports multiple users
- Durable electro-polished Gr.316 stainless steel brackets and traveller
- Meets the requirements of international standards.
- Permanently attached, Gr.316 stainless steel, smooth running two wheeled traveller easily passes intermediate brackets
- **KEELINE in-line shock absorber limits end loads to structure**
- **Suitable for single or multiple span systems**
- **Spans of up to 24m in between supports**
- End and intermediate brackets are installed directly to suitable structures, including steel or concrete.



Features and Benefits

Kee®
Line

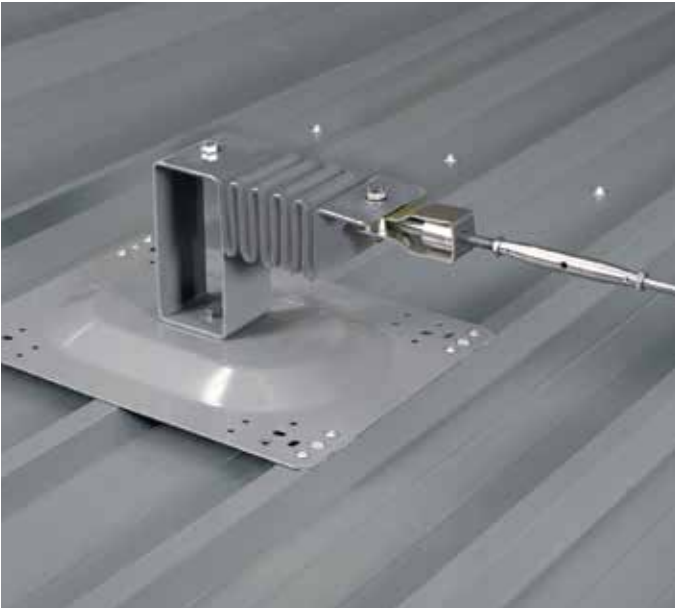

- Compliant with EN 795 2012, CEN TS 16415:2013, ANSI Z359 & CSA Z259
- Tested on multiple roof types
- Maximum span between posts of 12m
- Traveller can pass the whole length of the system without having to be detached at any point
- Open style, low profile post designed to suit metal profile and standing seam roofs.
- Specific membrane roof base plate and post allows simple weathering installation
- Galvanised mild steel or stainless steel parts
- Base plates allow multiple fixing options
- Proven system meeting all current legislative requirements
- Safety assurance that the system is fully functional on all approved surfaces
- Minimises the number of posts and roof fixings required
- The user is always connected to the system
- Posts designed to deploy and deform in event of a fall, minimising the load being applied to the building to below 10Kn
- Saves installation time and thereby reduces project costs.
- Long term corrosion resistance
- Easy ordering, reduced stockholding and less complexity for customers



KeeLine®

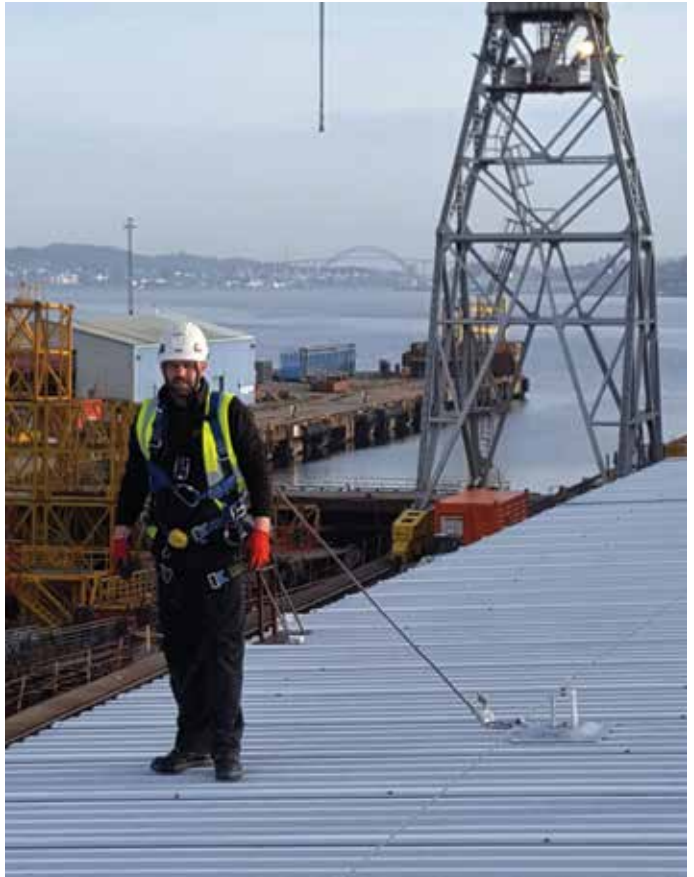

The Safety Solution for Roof Top Walkways

**Kee®
Walk**



KEE WALK provides a safe, anti-slip, level walking surface for anyone who needs to access a roof in the course of their work. It provides a clear demarcation route which protects the roof from unnecessary damage and uniformly distributes the pedestrian load across its surface.

The product caters for flat, barrel and sloping roofs, with steps and a traverse option allowing access to be created for virtually any roof configuration from 0 to 35 degrees.

KEE WALK is a modular system compliant with EN 516:2006 (Prefabricated Accessories for Roofing – Installations for roof access – Walkways, treads and steps).

Easy assembly utilising standard components removes the need to have parts specifically manufactured off-site, making installation and specification quick and simple.

KEE WALK is designed for modern roof types including trapezoidal profile composite or built up and standing seam roofs.



Features

- Provide a safe, level walkway across a roof surface
- Compliant with EN 516 Class 1-C (Prefabricated Accessories for Roofing – Installations for roof access – Walkways, treads and steps) and assists compliance with the Work at Heights regulations
- 1.5m & 3m pre-assembled lengths supplied as standard
- Designed for use on composite, trapezoidal metal profile and standing seam roofs
- Flexible, modular system adaptable to changing roof angles from 0 to 35 degrees; fully adjustable on-site
- Contrasts with roof surface to provide a clear demarcation route
- Nylon treads with enhanced slip resistance for adverse weather conditions
- Lightweight aluminium bearer bars for all roof types
- Minimal selection of brackets required to install a complete system
- Fixings do not damage the integrity of the roof surface
- No bespoke parts required
- Fire Rated to Class HB of UL94 (harmonised with ISO 9772)
- Open tread ensures water drains away easily.

Benefits

- Standard parts available from stock
- Ease of installation
- Slip resistance compliant to British Standard BS 4592
- Flexible, modular system adaptable to changing roof levels
- Rigid, solid construction ensures **KEE WALK** is secure under foot
- Treads and bearer bars are recyclable
- Clear on-roof demarcation to prevent the roof surface being damaged.



The Kee Walk® System

KEE WALK provides a flexible, easy to assemble walkway system designed for use on most modern roof types. To demonstrate the flexibility of the system, a brief explanation of the key constituent parts; the longitudinal configuration, the configuration to traverse a roof, the step configuration and the treads is given below.

The anti-slip characteristics of the walkway are essential for user safety. The British Standard (BS 4592) requires a minimum co-efficient of 0.4 as a measure of the friction and **KEE WALK** achieves almost double this in both wet and dry conditions. Specific fixing packs are supplied for the different roof types.

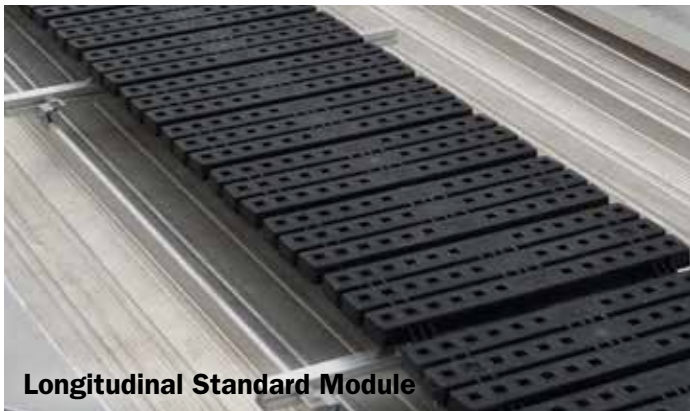

Longitudinal Standard Module

Longitudinal 3m Configuration

Supplied pre-assembled by Kee Safety to facilitate rapid on-site installation and thus minimise installation costs, these standard lengths have 12 treads per 3m. Weighing only 24kg, the standard lengths are easily positioned and aligned. They are joined together by a simple 100mm long straight connector which attaches to the bearer bars.



KEE WALK Traverse Walkway

Traverse Configuration

KEE WALK is designed to make the task of building a walkway across a sloping roof a straight forward installation, again using a standard set of components. A traverse section of walkway uses a standard **KEE WALK** section for the level walking surface which is mounted onto a sub-frame fixed to the roof. The two sections are joined with hinged brackets at the rear of the assembly and use the rotating arms at the front to level the walking surface, as depicted on the adjacent photograph.

Choices

The **KEE WALK** system is ideally suited to compliment horizontal life lines such as the **KEELINE** system.

Where collective protection is the preferred option on metal roofs it can also be used in conjunction with **KEEGUARD** Topfix, alternatively for flat roofs it can be used with the standard free standing **KEEGUARD** system.

For advice how to use **KEE WALK** for applications other than the standard configurations please contact **Kee Safety**.

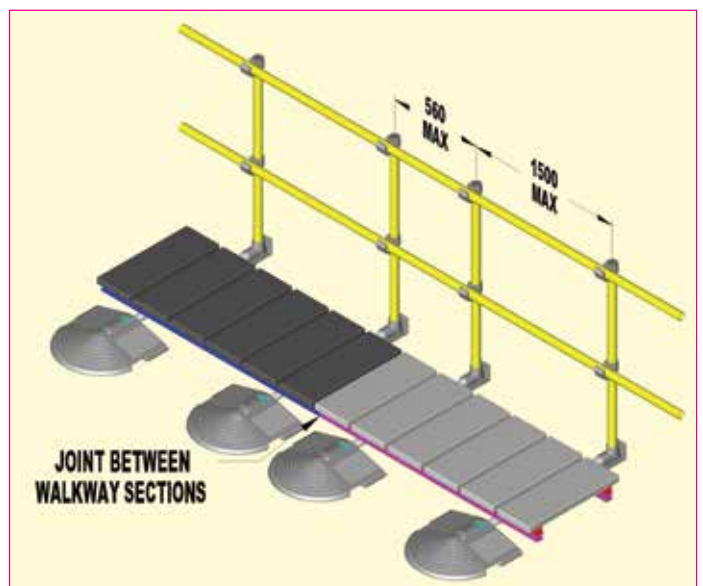

JOINT BETWEEN WALKWAY SECTIONS

The Kee Walk® System



Steps



Rotating Arms

Kee Safety provides pre-assembled step configurations in 3m or 1.5m lengths which require only minor adjustment on-site. The rotating arms (shown above) allow the installer to set the angle of the steps simply by removing the locating bolt, setting the horizontal angle and then replacing the bolt. The steps configurations will change depending on the pitch of the roof. Standard components are available for 5° - 10°, 10° - 15°, 15° - 25°, 25° - 35°, all which comply with the requirements of EN 516. Kee Safety can provide specific information on all the different step configurations as required.



KEE WALK steps

The Treads



A KEE WALK Tread

Manufactured in high grade nylon incorporating raised roughened sections, the treads are developed to comply with EN 516 (Prefabricated Accessories for Roofing – Installations for roof access – Walkways, treads and steps), exceeding the deflection criteria and slip resistance requirements of the standard.

The treads, when supplied separately to build steps or walkway sections less than the standard 1.5 or 3m pre-assembled sections, are quickly secured onto the aluminium bearer bars using two self drilling screws, fixed in the centre holes. Additional fixing holes are provided either side of the centre hole. Their design incorporates spacers to ensure simple, correct spacing and alignment. Treads can be cut down if required to fit between fixed points.

Each tread is 625mm long, 225mm wide and 35mm deep. Alternatively, Aluminium treads can be used.



Aluminium Treads

Test Requirements - EN 516-2006

- **EN 516 (Prefabricated Accessories for Roofing Installations for roof access – Walkways, treads and steps) Test Requirements**
- **Deflection Criteria on Walkways & Steps** - 1.5 kN concentrated load applied over an area of 100mm x 100mm. The deflection under load must not exceed 15mm or 1/100 of the span, whichever is the lesser.

- **Residual Deformation on Walkways & Steps**
- 2.6 kN concentrated load applied over an area of 100mm x 100mm at the front edge of the tread applied for 1 minute. The residual deformation after the load is removed should not exceed 5mm.

These criteria have been surpassed in all testing. The raised surfaces on the tread have a slightly coarse finish to enhance the slip resistance.

The **KEE I-BOLT** range offers a comprehensive selection of Class A1 safety anchors.

RINGANKA is a range of fixed Class A1 safety eyebolts and fixing components conforming to EN 795 and BS 7883.

KEYANKA is a removable eyebolt and a range of fixing solutions, which is unobtrusive where visual presentation is important.

It is important that the correct eyebolt is used to suit the material and that the positioning is determined by a competent person.



Safety Eyebolt

Ringanka®

A KEE SAFETY PRODUCT

RINGANKA is a range of fixed safety eyebolts for installation to an external or internal face of a structural element adjacent to a window or other access point.

RINGANKA is available in three different lengths suitable for use in a range of materials; brick, concrete, masonry and steel.

Available in three finishes, Electro-polished Grade 316 stainless steel, high tensile carbon steel with a sheradised or white plastic-coated finish.

BS 7883 requires that, wherever possible, all safety anchor devices are removable for periodic inspection; this is easily achieved by using our Knurled Inserts in conjunction with suitable resin. PPE Warning Labels are also available, which are required for compliance with EN 795.

A range of standard components allow the **RINGANKA** range to be fitted to a wide range of constructions including cavity walls and also can accommodate cantilevers up to 175mm (100mm in brickwork), for example when installing into buildings with false walls or cladding.

The positioning selection for these products should only be carried out by a competent person.

Features

- Comprehensive range of anchor bolts and accessories to suit most installations
- Available in Sheradised, White plastic coated and Stainless Steel
- Conforms to CLASS A1 EN 795 1996, BS 7883 & ISO 14567
- CE Approved to PPE Directive



Benefits

- Provides workers with safe means of access
- White plastic coated finish blends with most interior decor.

Removable Safety Eyebolt

Keyanka®

A KEE SAFETY PRODUCT

The **KEYANKA** safety eyebolt offers a removable unobtrusive solution to traditional eyebolts for use where aesthetics mean a detachable eyebolt is preferred. The permanently installed grade 316 stainless steel anchor socket is concealed by a flush fitting white plastic cover, which blends in with most interior designs.

Equipped with the **KEYANKA** eyebolt at the end of his lanyard, the operator uses a simple 'key' action with sprung locking movement, to provide a fast and safe attachment. The eyebolt is able to rotate 180° whilst still attached to the socket to provide the best orientation in event of a fall arrest situation, and can only be removed by five simple, separate but deliberate, sequential movements.



Features

- Removable Eyebolt
- Produced from Grade 316 Stainless Steel
- Spring loaded locking action
- Variety of fixing options including concrete, brick, steelwork and cavity walls
- Flush fitting white plastic cover to blend in with most interior designs
- Optional Stainless Steel Cap
- Conforms to CLASS A1 EN 795 1996, BS 7883 & ISO 14567
- CE Approved to PPE Directive

Benefits

- An unobtrusive solution to traditional eyebolts in more prestigious buildings
- Fast and safe attachment
- Eyebolt is able to rotate 180° whilst still attached to socket to provide best orientation in event of fall arrest situation
- Removes a potential trip hazard when required to be fitted into the floor
- Removes the potential of unauthorised or inappropriate use.

Fall Protection Photo Gallery



Kee Safety Shanghai
 上海市黄浦区延安东路588号
 远洋商业大厦一期16楼A,B座
 16AB Sino-Ocean Tower, 588
 Yan An East Road Shanghai,
 China

Tel: +86 400 820 9261

Email: chnsales@keesafety.com

Website: www.keesafety.cn