



YOU'LL NEVER BE BETTER PROTECTED

Components for Safety Barrier Solutions



THE KEE KLAMP® CONCEPT

Kee Safety® is a leading global supplier of components and custom safety systems. Our systems are quick and easy to design and install, and are very cost effective due to their modularity.



CONTENTS

1. Technical information	Page 4
2. Kee Klamp components	Page 6
3. Kee Klamp range of access components	Page 32
4. Kee Lite components	Page 40
5. Accessories	Page 54
6. Specifying components	Page 55
7. Assembly and installation	Page 56
8. Load tables	Page 63
9. Vibration tests	Page 66

The principle is simple yet highly effective, proven over 80 years in thousands of completed projects across the globe. Whether you need to separate people from hazards or protect your equipment on site, Kee Safety offers the most cost effective, flexible and safe solutions to your barrier requirements.

Safety

Kee Safety regularly monitors all new safety standards and directives to ensure the highest protection. Our systems not only meet but also exceed the current safety requirements and our components comply with the latest USA Building Regulations and Standards.

Quality

Quality is the overriding priority when manufacturing Kee Safety components. Components are manufactured to strict specifications and TÜV certified for strength, manufacturing quality and consistency.

Solutions

From simple protection for loading bays or safety walkways in factories, to safety barriers in aggressive coastal environments or the protection of road bridges and culverts, Kee Safety provides you with confidence that you are compliant with safety requirements.

Kee Klamp®



Kee Lite®



An innovative product for the construction of steel tubular structures. Kee Klamp® components are galvanized cast iron for strength and corrosion resistance.

Go to page **6**

The Kee Klamp access range of galvanized cast iron components are suitable for railings, stairs, ramps and walkways. They are specially designed for disabled access, meeting the requirements of the Americans with Disabilities Act.

Go to page **32**

Components manufactured from a polished high grade Aluminum alloy for the construction of lightweight tubular structures. Kee Lite® components offer superior corrosion resistance, strength and durability.

Go to page **40**

Kee Klamp®

Galvanized Iron Components

The engineering principle behind the Kee Klamp component is the foundation of the most versatile pipe connection system available. We provide the versatility needed to achieve virtually any structure configuration.



A SUPERIOR SOLUTION

Steel pipe is an inherently efficient structural component. It is strong, has no sharp corners, and is readily available worldwide. The difficulty in using steel pipe to form structures arises when joining. Threaded pipe must be supplied in set lengths making for zero flexibility in installation. Welding is labor intensive, requires a highly skilled workforce, and specialised equipment.

Kee Klamp components are iron castings manufactured to the requirements of BS EN 1562 and 1563.

Kee Klamp components have the widest selection composing a range of components to suit seven different sizes of pipe.

Hexagon socket set screws firmly lock the component to the pipe. Set screws are manufactured in case hardened steel and are protected against corrosion with Kee Koat. This ensures that tubular structures achieve longer life and better corrosion resistance.

A Kee Klamp component (size 5 to 9) can support an axial load of 2000lbs. per set screw with the set screw tightened to a torque of 39 Nm or 29 ft.lbs; rating includes a safety factor of 2:1.

This is normally obtained when the set screw is fully tightened using a ratchet wrench.

Components by Function

BASES

62	Standard Railing
63	Angle Base
363	Angle Base Flange 11°–30°
64	Vertical Railing
65	Horizontal Railing
66	Ground
67	Angle
68	Wall
69	Rail w/ Toe Adaptor
115	Wall
262	Round Flange
265	Offset Rail Wall
316	Parapet Clips

CLIPS

79	Sheeting
81	Single Sided
82	Double Sided
105	Sheeting w/o hardware

COUPLINGS

14	Straight
18	Internal
145	Crossover Crosses

CROSSES

26	Two Socket
A26	Split Two Socket
326	Level to Sloping Down or Up 30°–45°
328	Two Socket Cross 11°–30°
30	Adjustable 30°–45°
35	Three Socket
A35	Split Three Socket
40	Four Socket
A40	Split Four Socket
89	Two Socket Angle
91	PGR Two Socket Cross
623	High Capacity Base Flange

CROSSOVERS

17	Clamp-on
45	Crossover
A45	Split
46	Combination Socket Tee
121	Corner

ELBOWS

15	90°
20	Side Outlet
BC53	Swivel
55	Obtuse Angle
55A	Variable 11°–30°
56	Acute Angle
56A	Acute Angle 11°–30°
87	Angle
92	PGR
320LH	Left hand level to Sloping Down Side 30°–45°
320RH	Right hand level to Sloping Down Side 30°–45°

FLANGES

31	Pallet
C58	Swivel
P58	Double Central Flange
59	Spigot
60	Extra Heavy
61	Flange
70	Rail Support

SWIVEL SOCKETS

C50	Single Combination
F50	Female Single
M50	Male Single
MH50	Male Single Horizontal
C51	Double
M51	Male Double Member
MH51	Male Double Horizontal Member
C52	Corner
M52	Male Corner
C53	Adjustable Three Way
M53	Variable Angle Double
M58	Swivel Flange Plate
78/83	Gate Hinge Set Tab Panels

TAB PANELS

P50	Offset Sing. w/ Slot
P51	Offset Double w/ Slot
P57	Single w/ Slot
P57E	Modified P57
P58	Double w/ CSH

TEES/SOCKETS

10	Single Socket
A10	Split Single Socket
12	Single Socket 45°
A12	Split Single Socket 45°
16	Clamp-on
19	Adjustable Side Outlet
21	90° Side Outlet
A21	Split 90° Side Outlet
25	Three Socket
327	Three Socket 11°–30°
427	Three Socket Tee 30°–45°
29	Single Socket 30°–60°
329	Single Socket Tee 11°–30°
46	Combination Crossover
8	Angle
88	Three Socket Angle
90	PGR Three Socket
93	Pedestrian Guard Rail
114	Swivel
321LH	Left hand level to Sloping Down Side Outlet 30°–45°
321RH	Right hand level to Sloping Down Side Outlet 30°–45°
325	Level to Sloping Down 30°–45°
325A	Level to Sloping Up 30°–45°

PLUGS

77	Plastic
84	Malleable

MISCELLANEOUS

32	Decorative Ball
71	Weather Cap
72	Stair Tread Support
75	Collar
76	Hook
95	PGR Internal Spigot
97	Set Screw
99	Hex Key
100	Plastic Set Screw Caps
S115	Packer Plate for Type 115
118	Rose Cover
350	Eaves Fitting
351	Ridge Fitting

10

Single Socket Tee

This component creates a 90° perpendicular joint between two pipes.

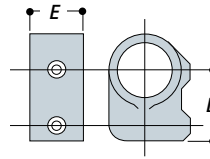
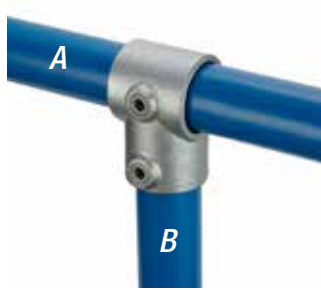

TYPE	Pipe ref.		in.		lb.
	A	B	D	E	
10-3	3	3	1.13	0.94	0.15
10-4	4	4	1.36	1.20	0.29
10-5	5	5	1.63	1.47	0.51
10-6	6	6	1.81	1.84	0.64
10-65	6	5	1.75	1.42	0.55
10-67	6	7	2.20	2.06	0.95
10-7	7	7	2.38	2.16	0.99
10-75	7	5	2.25	1.44	0.71
10-76	7	6	2.25	1.80	0.95
10-78	7	8	2.88	2.38	1.39
10-8	8	8	2.69	2.38	1.28
10-87	8	7	2.47	2.03	1.10
10-9	9	9	3.31	2.88	2.14
10-98	9	8	2.94	2.50	1.43

A10

Split Single Socket Tee

Designed to allow additions or extensions to existing structures, this component creates a 90° perpendicular joint between two pipes without the need for dismantling. This component has strength and function comparable the standard Type 10.

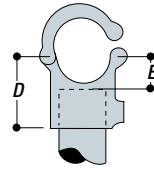
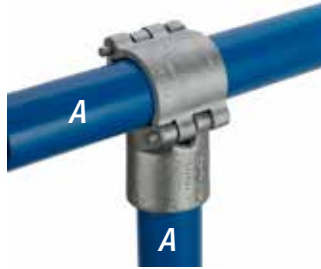

Note: The A10-8 differs from the picture because it is formed with the A21/A26 components.

TYPE	Pipe ref.	in.		lb.
		A	D	
A10-7	7	2.36	1.10	1.26
A10-8	8	3.46	2.36	1.59

12

Single Socket Tee (45°)

Engineered to create 45° angle, this component is most frequently used for bracing and struts.

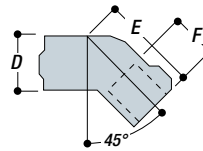

TYPE	Pipe ref.	in.			lb.
		A	D	F	
12-5	5	1.46	2.83	1.38	0.66
12-6	6	1.73	3.35	1.38	0.95
12-7	7	2.17	3.70	1.58	1.56
12-8	8	2.36	4.25	1.58	2.02

A12

Split Single Socket Tee (45°)

The hinge and pin system of this component enables existing structures to be easily extended without the need for dismantling. This component is most frequently used for bracing and struts.

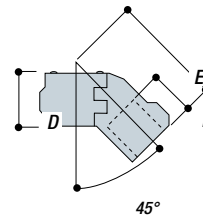

TYPE	Pipe ref.	in.			lb.
		A	D	F	
A12-8	8	2.36	4.80	2.05	2.36

14

Straight Coupling

Designed to form an in-line joint between two pieces of pipe of the same size. The Type 14 Straight Coupling creates a join on the outside of the pipe and is stronger than internal couplings.

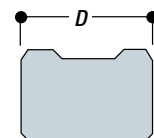

TYPE	Pipe ref.	in.	lb.
14-4	4	2.28	0.31
14-5	5	3.03	0.60
14-6	6	3.50	0.86
14-7	7	4.01	1.15
14-8	8	4.09	1.41
14-9	9	4.88	2.38

15

Elbow (90°)

This elbow creates a 90° joint between two pieces of pipe.

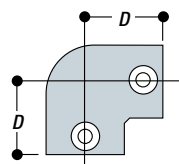
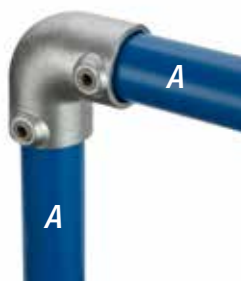

TYPE	Pipe ref.		in.		lb.
	A	B	D	E	
15-4	4		1.33		0.29
15-5	5		1.61		0.60
15-6	6		1.81		0.86
15-7	7		2.36		1.48
15-8	8		2.67		1.70
15-9	9		3.34		2.82

16

Clamp-on Tee

Widely used for adding to and modifying existing structures, this component performs the same function as a Type 10. Because of its open socket, it can be added to a complete structure. The hex head bolt is for retaining purposes only and should be tightened to 15Nm.

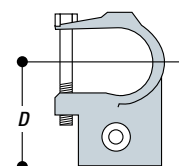
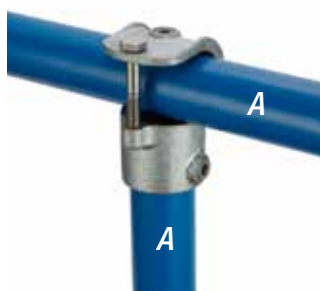

TYPE	Pipe ref.		in.		lb.
	A	B	D	E	
16-5	5		1.97		0.64
16-6	6		2.09		0.73
16-7	7		2.64		1.30
16-8	8		3.03		1.32
16-9	9		3.54		2.03

17

Clamp-on Crossover

Designed to provide a 90° crossover joint. Can be added to an existing structure. Pipe should not be joined within this component. For an alternative component, see Type 45 or Type A45.

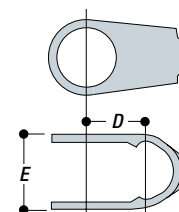
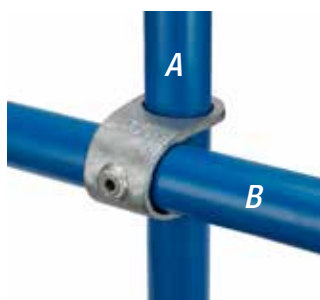

TYPE	Pipe ref.		in.		lb.
	A	B	D	E	
17-5	5		1.06	1.61	0.33
17-6	6		1.34	1.89	0.51
17-7	7		1.69	2.48	0.95
17-8	8		1.93	2.68	1.23
17-9	9		2.40	3.07	1.98

18

Internal Coupling

The Internal Coupling creates a flush joint between two pipes of the same diameter. This component should not be used where a direct tensile load is applied.

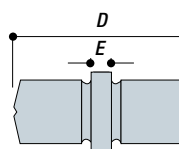

TYPE	Pipe ref.		in.		lb.
	A	B	D	E	
18-6	6		2.99	0.79	0.57
18-7	7		2.99	0.79	0.84
18-8	8		3.74	0.79	1.19

Note: This component can only be used with Schedule 40 pipe.

WARNING: Type 18 coupling must not be used as a load bearing joint.

19

Adjustable Side Outlet Tee

Used in pairs to form variable angle joints between 90° and 180°. Type 19-8T can produce an angle range between 81° and 180°.

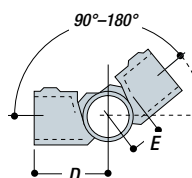
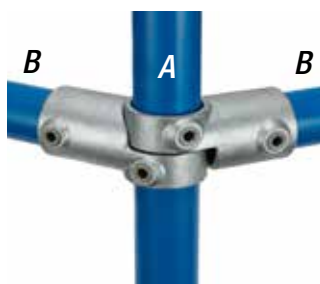

TYPE	Pipe ref.		in.		lb.
	A	B	D	E	
19-5	5	5	2.36	1.22	0.44
19-6	6	6	2.28	1.30	0.64
19-7	7	7	2.87	1.57	0.90
19-8	8	8	3.54	2.17	1.17
19-85	8	8	2.87	1.77	1.43
19-8T	8	8	3.54	2.32	1.41
19-9	9	9	4.33	1.93	2.18

Note: Pairs sold and priced separately in UK, France, and Germany.

20

Side Outlet Elbow

This component creates a 90° corner joint for three pieces of pipe. Most frequently used for the top-rail of safety railing, it can also be considered for the corner joint of benches, work tables, and other rectangular structures.

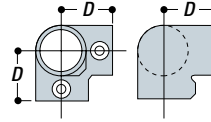
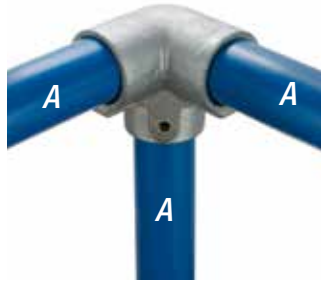

TYPE	Pipe ref.		in.		lb.
	A	D	D		
20-4	4		1.34		0.37
20-5	5		1.61		0.84
20-6	6		1.81		1.06
20-7	7		2.36		1.79
20-8	8		2.68		2.49
20-9	9		3.35		4.01

21

Side Outlet Tee (90°)

Most frequently paired with Type 20 to give a 90° corner joint for the middle rail of safety railing and other rectangular structures. The upright passes through the component.

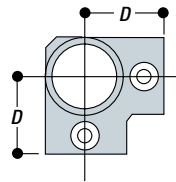
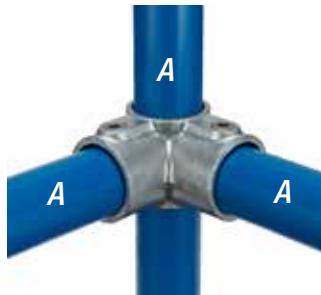

TYPE	Pipe ref.		in.		lb.
	A	D	D		
21-4	4		1.34		0.31
21-5	5		1.61		0.62
21-6	6		1.81		0.90
21-7	7		2.36		1.52
21-8	8		2.68		1.87
21-9	9		3.35		3.00

A21/A26

Split Two socket Cross/ Side Outlet Tee (90°)

This component performs the same function as either Type 21 or Type 26. Because of its hinge and pin system, it can be added to an existing tubular assembly. Type A21/A26 components are supplied and priced as a kit that includes two castings and two taper pins, which can be assembled in either configuration.

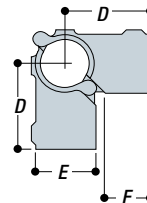
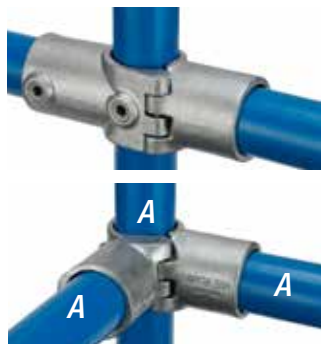

TYPE	Pipe ref.		in.			lb.
	A	D	E	F		
A21/A26-8	8		3.46	2.36	2.16	2.36

25

Three Socket Tee

The Three Socket Tee will join three pipes together in a 90° perpendicular joint. The two set screws in the sleeve will allow two pipes to be coupled together. This components is most commonly used between the top-rail and an intermediate upright on safety railing.

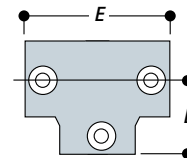
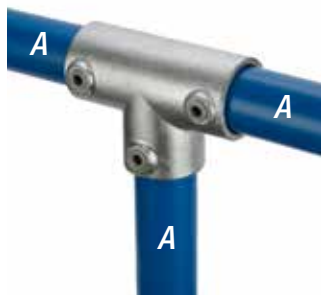

TYPE	Pipe ref.		in.		lb.
	A	D	D	E	
25-4	4		1.34	2.68	0.40
25-5	5		1.61	3.23	0.82
25-6	6		1.81	3.62	1.08
25-7	7		2.36	4.72	1.87
25-8	8		2.68	5.35	2.40
25-9	9		3.35	6.61	3.84

26

Two Socket Cross

Usually paired with Type 25 to give a 90° joint between the middle rail and an intermediate upright on safety railing. The upright passes through the component.

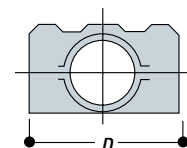
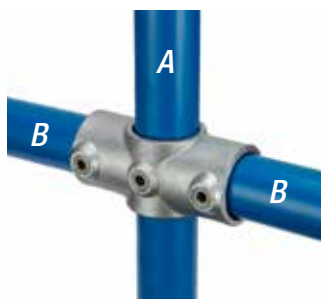

TYPE	Pipe ref.		in.		lb.
	A	B	D		
26-4	4	4	2.68		0.29
26-5	5	5	3.23		0.60
26-6	6	6	3.62		0.88
26-7	7	7	4.72		1.43
26-8	8	8	5.35		1.87
26-87	8	7	4.96		1.39
26-9	9	9	6.61		3.22

29

Single Socket Tee (30°-60°)

Designed as an alternative to Type 12, this adjustable component is most frequently used for bracing and struts. It may be used at any angle between 30° and 60°. See diagram on page 59.

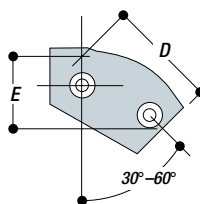
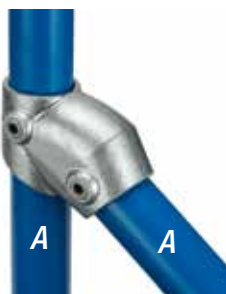

TYPE	Pipe ref.	in.			lb.
	A	D	E		
29-6	6	3.23	2.55	0.97	
29-7	7	3.66	2.91	1.39	
29-8	8	4.02	2.68	2.14	

30

Adjustable Cross (30°-45°)

This adjustable component can be used for railing on staircases between the mid-rail and an intermediate upright which is required to remain vertical. It may be used at any selected angle between 30° and 45°.

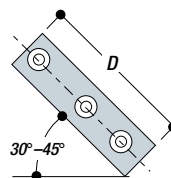
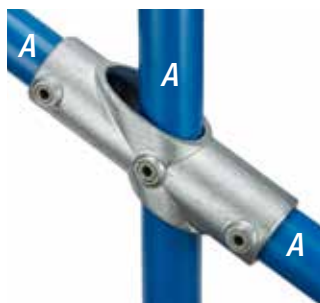

TYPE	Pipe ref.	in.			lb.
	A	D	E		
30-6	6	5.75		1.41	
30-7	7	7.01		2.14	
30-8	8	8.50		2.87	

31

Pallet Flange

This component has been designed for the construction of post pallets. Incorporates sockets for the upright and side pipes, and a locating bell for stacking pallets. (Special order only.)

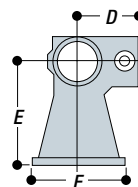

TYPE	Pipe ref.	in.			lb.
	A	D	E	F	
31-8	8	2.99	5	4.53	4.41

32

Decorative Ball

Our Decorative Ball cap is an aesthetic component suitable for handrails used for pedestrian traffic and municipal areas. The component also serves a functional purpose in discouraging skateboarders and other pedestrian traffic from sliding across a railing.

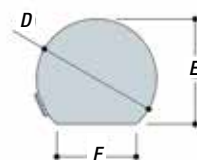

TYPE	Pipe ref.	in.			lb.
	A	D	E	F	
32-7	6	2.75	2.36	1.93	1.47
32-8	7	3.15	2.75	2.09	2.2

35

Three Socket Cross

Most frequently used to connect uprights with horizontal pipes in three directions, all at 90° to the upright. The upright passes through the component.

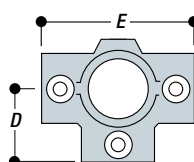
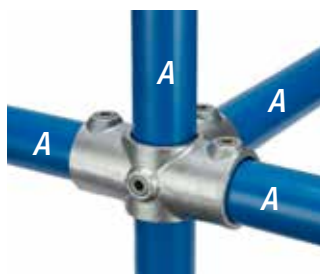

TYPE	Pipe ref.	in.		lb.
	A	D	E	
35-4	4	1.34	2.68	0.44
35-5	5	1.61	3.23	0.77
35-6	6	1.81	3.62	0.99
35-7	7	2.36	4.72	1.70
35-8	8	2.68	5.35	2.62
35-9	9	3.35	6.61	4.04

A35

Split Three Socket Cross

The hinge and pin system of this component enables existing structures to be easily extended without the need for dismantling. This component has been designed to connect an upright with horizontal pipes in three directions, all at 90° to the upright. The upright passes through the component.

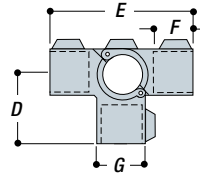
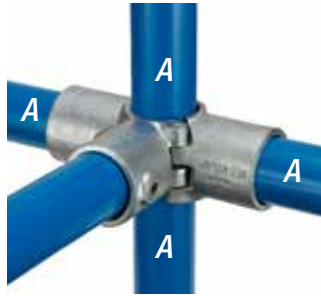

TYPE	Pipe ref.		in.				lb.
	A	D	E	F	G		
A35-8	8	3.46	6.93	2.17	2.36	3.46	

40

Four Socket Cross

Most frequently used in multiple upright structures to tie a centre upright with horizontal pipes in four directions. The upright passes through the component.

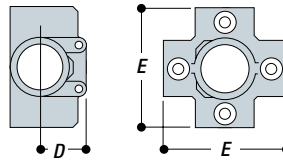
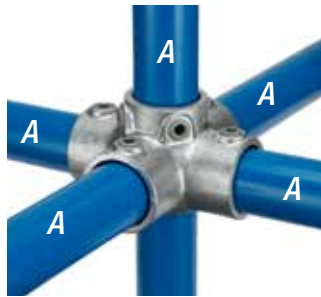

TYPE	Pipe ref.		in.		lb.
	A	D	E	E	
40-4	4	1.34	2.64	0.6	
40-5	5	1.26	3.23	1.12	
40-6	6	1.46	3.62	1.32	
40-7	7	1.81	4.72	2.32	
40-8	8	2.09	5.35	3.22	
40-9	9	2.44	6.61	5.07	

A40

Split Four Socket Cross

The hinge and pin system of this component enables existing structures to be easily extended without the need for dismantling. This component is most frequently used in multiple upright structures to tie a centre upright with horizontal pipes in four directions. The upright passes through the component.

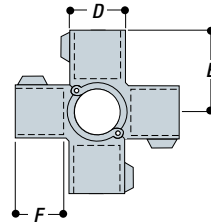
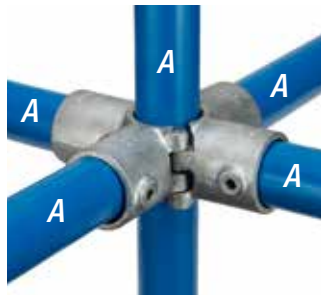

TYPE	Pipe ref.		in.			lb.
	A	D	E	F		
A40-8	8	2.36	3.46	2.17	4.32	

45

Crossover

Designed to create a 90° crossover joint. Frequently used to minimise pipe cuts and create a continuous horizontal for safety railing. It may also be used to create intermediate levels on racks, when horizontal connections between uprights are not required.

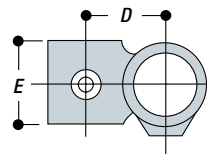
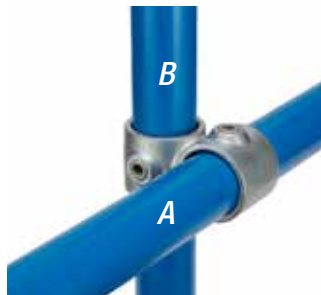

TYPE	Pipe ref.		in.		lb.
	A	B	D	E	
45-3	3	3	0.83	0.94	0.16
45-4	4	4	0.98	1.10	0.34
45-5	5	5	1.34	1.22	0.45
45-6	6	6	1.57	1.50	0.76
45-65	6	5	1.42	1.69	0.64
45-7	7	7	2.13	1.81	1.18
45-76	7	6	1.77	1.81	0.99
45-8	8	8	2.17	2.01	1.30
45-86	8	6	1.89	2.00	1.00
45-87	8	7	2.01	2.00	1.20
45-9	9	9	2.64	2.40	2.00
45-98	9	8	2.36	2.99	2.40

A45

Split Crossover

The unique hinge and pin system of this component enables existing structures to be easily extended without the need for dismantling. This component is designed to give a 90° offset crossover joint. Pipe should not be joined within the component. Type A45 function is comparable to Type 45 component.

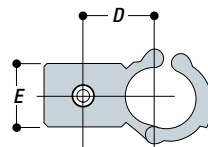
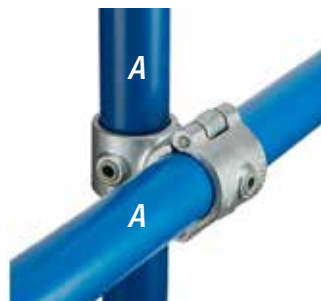

TYPE	Pipe ref.		in.		lb.
	A	D	E		
A45-7	7	1.93	1.81	1.43	
A45-8	8	2.17	1.96	1.74	

Kee Lite Aluminum version available

46

Combination Socket Tee and Crossover

Used on racking to join horizontal carrying rails to the upright, leaving the socket to take a horizontal tie across the section. For shelved racking it is usual to have the horizontal pipe outside the upright. On pallet racking it is preferable to have the carrying rails inside the upright.

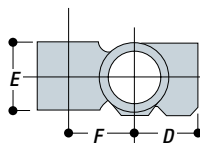
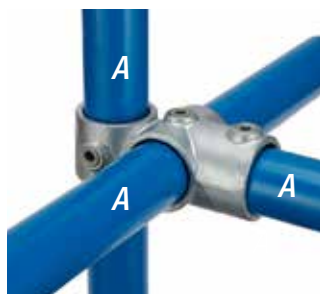

TYPE	Pipe ref.	in.			lb.
		A	D	E F	
46-4	4	1.34	1.10	0.98	0.33
46-5	5	1.61	1.22	1.34	0.66
46-6	6	1.81	1.50	1.57	1.08
46-7	7	2.36	1.81	1.93	1.52
46-8	8	2.68	2.01	2.17	2.01
46-9	9	3.35	2.40	2.64	3.40

Swivel Components

Types F50, M50, MH50, M51, MH51, M52, M53 and M58 are known as swivel components and can be assembled as Types C50, CH50, C51, C52, C53 and C58, or supplied as separate items. They are frequently used for bracing but can also overcome problems where joints are required at angles other than those achieved by fixed angle components. For economical use of piping, when making 'C' components, or combination components, Types F50 (sizes 5 to 9 only) can be combined with different sizes of Types M50, MH50, M51, MH51, M52, M53 and M58. F50-4 and M50-4 will only combine with each other.

WARNING: An entire structure should not be constructed from swivel components, as they would not provide sufficient stability or rigidity in the structure. Types M50, MH50, M51, M52, M53 and M58 can also be used separately to secure various types of in-fill panel. These components are not designed to take bending moments.

C50

Single Swivel Socket

This complete combination component creates a range of 170°. See Types F50 and M50 for individual component specifications. See the 'Swivel Components' box for more information.

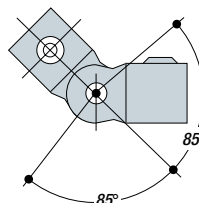
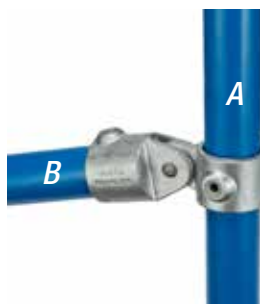

TYPE	Pipe ref.		lb.
	A	B	
C50-44	4	4	0.33
C50-55	5	5	1.23
C50-66	6	6	1.41
C50-77	7	7	1.76
C50-88	8	8	2.01
C50-99	9	9	2.69

F50

Female Single Swivel Socket Member

One part of combination component C50. The Type F50 in size 4 has only one ear, while Type F50 in sizes 5 to 9 has two ears.

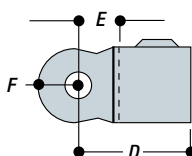

Note: Type F50-4 will only mate with a Type M50-4.

TYPE	Pipe ref.	in.				lb.
		A	D	E	F	
F50-4	4	1.42	0.55	0.43	0.26	0.15
F50-5	5	2.36	0.98	0.75	0.39	0.62
F50-6	6	2.36	0.98	0.75	0.39	0.75
F50-7	7	2.68	0.98	0.75	0.39	0.93
F50-8	8	2.99	0.98	0.75	0.39	1.15
F50-9	9	3.35	1.02	0.75	0.39	1.43

Ø indicates the diameter of the fixing hole.

M50

Male Single Swivel Socket Member

One part of combination component C50. This can also be used for attaching flat panels to tubular structures.

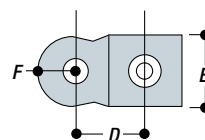

Note: Type M50-4 will only mate with a Type F50-4.

TYPE	Pipe ref.	in.				lb.
		A	D	E	F	
M50-4	4	1.02	0.76	0.43	0.25	0.13
M50-5	5	1.57	1.57	0.75	0.39	0.53
M50-6	6	1.69	1.57	0.75	0.39	0.60
M50-7	7	1.89	1.85	0.75	0.39	0.79
M50-8	8	2.13	1.85	0.75	0.39	0.92
M50-9	9	2.44	2.05	0.75	0.39	1.19

Ø indicates the diameter of the fixing hole.

MH50

Male Single Horizontal Swivel Socket Member

This component can be used for attaching flat panels to tubular structures. Specially designed for retail shelving applications. Can also be used as part of a Type CH50 combination component.

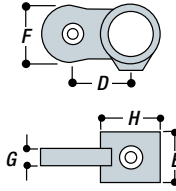

TYPE	Pipe ref.	in.						lb.
		A	D	E	F	G	H	
MH50-6	6	1.69	1.42	1.50	0.43	1.81	0.39	0.66

Ø indicates the diameter of the fixing hole.

P50

Single Offset Panel Tab

Designed for the securing of various types of panels and flooring to pipe structures (i.e. plywood, plastic sheeting, wood planking, etc.). This component has one offset flange to allow the flush attachment of panels to pipe. Often used with Type P51. See also Type P57.

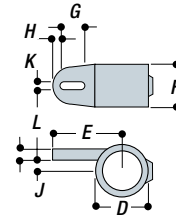

TYPE	Pipe ref.	in.							lb.	
		A	D	E	F	G	H	J		K
P50-8	8	2.40	3.15	1.85	1.26	0.31	0.39	0.43	0.51	1.06

C51

Double Swivel Socket

This complete combination component creates a range of 170° on both sides of the upright. Type C51 is made by combining two Type F50 components and one Type M51. For dimensions refer to Type F50 and Type M51. See the 'Swivel Components' box for more information.

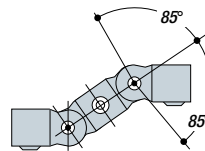
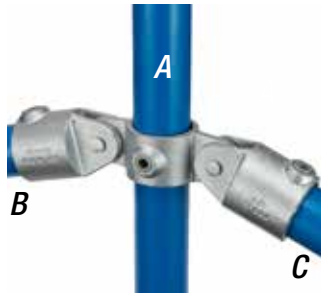

TYPE	Pipe ref.			lb.
	A	B	C	
C51-555	5	5	5	2.18
C51-666	6	6	6	2.45
C51-777	7	7	7	2.98
C51-888	8	8	8	3.46
C51-999	9	9	9	4.54

M51

Male Double Swivel Socket Member

One part of a Type C51 combination component. This component can also be used for attaching flat panels to tubular structures.

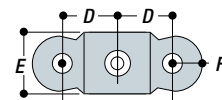

TYPE	Pipe ref.	in.				lb.
		D	E	F	Ø	
M51-5	5	1.57	1.57	0.75	0.39	0.73
M51-6	6	1.69	1.57	0.75	0.39	0.84
M51-7	7	1.89	1.85	0.75	0.39	1.01
M51-8	8	2.13	1.85	0.75	0.39	1.06
M51-9	9	2.44	2.05	0.75	0.39	1.57

Ø indicates the diameter of the fixing hole.

MH51

Male Double Horizontal Swivel Socket Member

This component can be used for attaching flat panels to tubular structures. Specially designed for retail shelving applications, the MH51 can be used as part of a CH51 combination component.

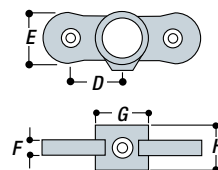

TYPE	Pipe ref.	in.						lb.
		D	E	F	G	H	Ø	
MH51-6	6	1.69	1.50	0.43	1.81	1.50	0.39	0.97

Ø indicates the diameter of the fixing hole.

Keel Lite Aluminum version available

P51

Double Offset Panel Tab

Designed for the secure component of various types of panels and flooring to pipe structures (i.e. plywood, plastic sheeting, wood planking, etc.) This component has two offset flanges to allow the flush attachment of panels to pipe.

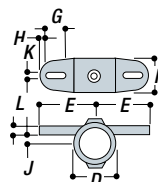

TYPE	Pipe ref.	in.							lb.	
	A	D	E	F	G	H	J	K		L
P51-8	8	2.40	3.19	1.85	1.26	0.31	0.51	0.43	0.39	1.54

C52

Corner Swivel Socket

Complete combination component. Reducing combinations of Type C52 are available sizes 5 to 8. For dimensions refer to Type F50 and Type M52. See the 'Swivel Components' box for more information.

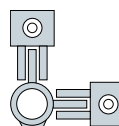
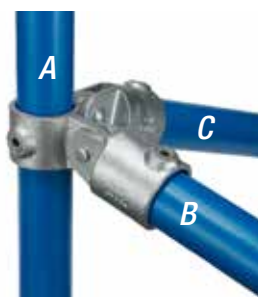

TYPE	Pipe ref.			lb.
	A	B	C	
C52-555	5	5	5	2.14
C52-666	6	6	6	2.47
C52-777	7	7	7	2.96
C52-888	8	8	8	3.42

M52

Male Corner Swivel Socket Member

One part of a Type C52 combination component. This can also be used for attaching flat panels to tubular structures.

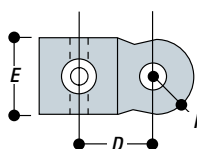

TYPE	Pipe ref.	in.				lb.
	A	D	E	F	Ø	
M52-5	5	1.57	1.57	0.75	0.39	0.84
M52-6	6	1.69	1.57	0.75	0.39	0.82
M52-7	7	1.89	1.85	0.75	0.39	0.98
M52-8	8	2.13	1.85	0.75	0.39	1.00

Ø indicates the diameter of the fixing hole.

BC53

Swivel Elbow

Type BC53 component has been designed as a variable angle in-line connection, adjustable through 272°.

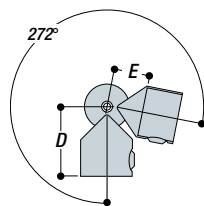

TYPE	Pipe ref.	in.		lb.
	A	D	E	
BC53-66	6	2.36	1.30	1.12
BC53-77	7	2.87	1.42	1.78
BC53-88	8	3.35	1.77	2.48

WARNING: An entire structure should not be constructed from Type BC53-88 or any other swivel component, as these would not provide sufficient stability or rigidity in the structure due to the free rotation of the component.

C53

Adjustable Three Way Swivel Socket

Complete combination component. Type C53 is made by combining two Type M53 and two Type F50 components. For dimensions refer to Type F50 and type M53. See the 'Swivel Components' box for more information.

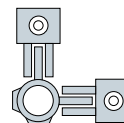
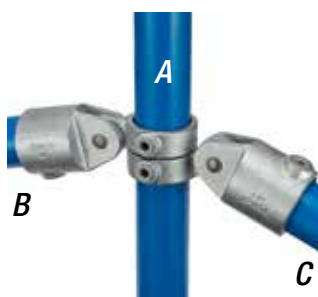

TYPE	Pipe ref.	in.			lb.
	A	B	C	Ø	
C53-888	8	8	8	0.41	3.39

Ø indicates the diameter of the fixing hole.

M53

Variable Angle Double Swivel Socket Member

A part of a Type C53 combination component. Type C53 is made by combining two Type M53 and two Type F50 components.

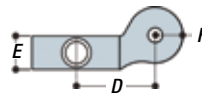

TYPE	Pipe ref.		in.				lb.
	A	D	E	F	Ø		
M53-8	8	2.13	0.91	0.75	0.41	0.55	

Ø indicates the diameter of the fixing hole.

55

Obtuse Angle Elbow

The Type 55 is an ideal component to use as an alternative to bending, or when a junction between a sloping pipe and an end post is required, i.e. guardrail and staircases. (Refer to page 59 for more information.)

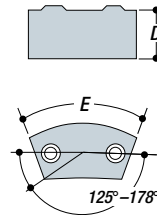

TYPE	Pipe ref.		in.		lb.
	A	D	E		
55-6	6	1.81	4.57		1.12
55-7	7	2.17	6.06		1.80
55-8	8	2.36	6.02		1.90

55A

Variable Elbow (11°-30°)

The Type 55A is an ideal component to use as an alternative to bending, or when a junction between a sloping pipe and an end post is required.

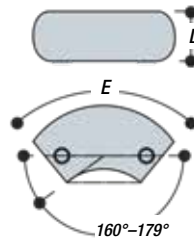

TYPE	Pipe ref.		in.		lb.
	A	D	E		
55A-7	7	2.16	4.53		2.2
55A-8	8	2.36	5.90		2.82

56

Acute Angle Elbow (30°-45°)

Type 56 is an ideal component to use as an alternative to bending, or when a junction between a sloping pipe and an end post is required, i.e. guardrail and staircases. (Refer to page 59 for more information.)

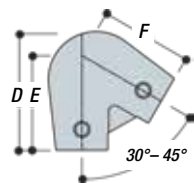

TYPE	Pipe ref.		in.			lb.
	A	D	E	F		
56-7	7	4.13	3.90	3.90	2.16	
56-8	8	5.28	4.41	4.41	2.92	

56A

Acute Angle Elbow (11°-30°)

Type 56A is an ideal component to use as an alternative to bending, or when a junction between a sloping pipe and an end post is required i.e. guardrail on staircases between 11° and 30°.

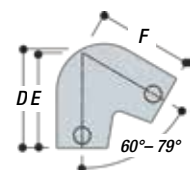
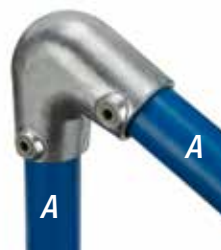

TYPE	Pipe ref.		in.			lb.
	A	D	E	F		
56A-7	7	4.72	4.26	4.26	2.07	
56A-8	8	4.92	4.41	4.41	2.46	

Kee Lite Aluminum version available 

P57

Single Panel Tab

Designed for the securing of various types of panels and flooring to pipe structures (i.e. plywood, plastic sheeting, wood planking, etc.). This component has a single offset flange to allow for the attachment of panels to pipe. See Type P50.

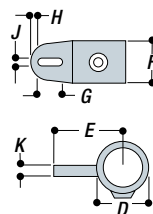

TYPE	Pipe ref.	in.							lb.
	A	D	E	F	G	H	J	K	
P57-8	8	2.40	3.19	1.85	1.26	0.31	0.39	0.43	1.54

P57E

Single Extended Panel Tab

This component is similar to the P57-8 but has an elongated offset flange with a fixing hole rather than a slot.

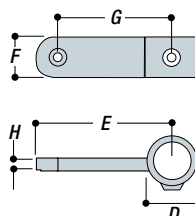
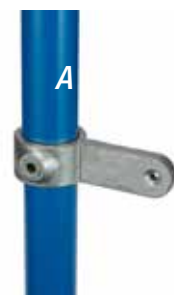

TYPE	Pipe ref.	in.							lb.
	A	D	E	F	G	H	Ø		
P57E-7	7	2.16	4.05	1.26	3.38	0.43	0.25	0.81	

Ø indicates the diameter of the fixing hole.

C58

Swivel Flange

A swivel component for attachment of angled piping to a flat surface. For dimensions refer to Type F50 and Type M58.

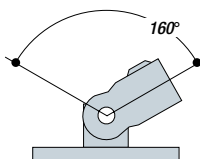

TYPE	Pipe ref.	lb.
	A	
C58-5	5	1.54
C58-6	6	1.68
C58-7	7	1.85
C58-8	8	2.07
C58-9	9	2.36

 **WARNING:** C58 is not recommended for use as a base flange to support guardrail, balustrades or other types of structure.

M58

Swivel Flange Plate

This component may be considered for various wall and brace fixings. It is often combined with Type F50 to give an adjustable angle component Type C58. The diameter of the attachment bolt hole is 0.39 inches (10mm).

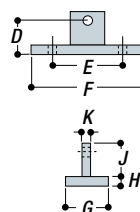

TYPE	in.								lb.
	D	E	F	G	H	J	K	Ø	
M58	1.34	3.27	4.41	2.05	0.24	1.77	0.35	0.47	0.82

Ø indicates the diameter of the fixing hole.

P58

Double Extended Panel Tab

This component is designed for securing various types of panels and flooring to tubular structures. It has central flanges with fixing holes.

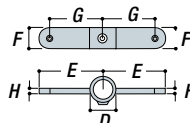
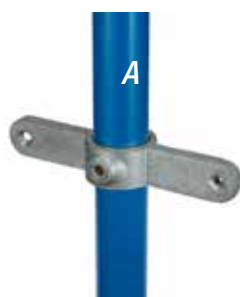

TYPE	Pipe ref.	in.							lb.
	A	D	E	F	G	H	Ø		
P58-7	7	2.15	4.06	1.26	3.39	0.43	0.25	1.23	

Ø indicates the diameter of the fixing hole.

59

Spigot Flange

A spigot flange which fits inside the pipe and is not secured by a socket screw. Type 59 can only be used with a pipe wall thickness of 1/8" and in light, self supporting structures.

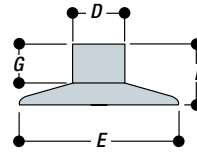

Note: No fixing holes are provided in this component.

TYPE	Pipe ref.	in.					lb.
		A	D	E	F	G	
59-5	5	0.75	3.19	1.10	0.71		0.73
59-6	6	1.02	3.43	1.26	0.87		0.88
59-7	7	1.30	3.86	1.34	1.00		1.32
59-8	8	1.50	4.09	2.05	1.18		1.87

60

Extra Heavy Flange

Heavy duty flange with wide base for spreading loads over a large surface area. Holes provided for countersunk flat head screw fixings only. For use on structures where the fixing required is positional only. Frequently used as a wall fixing bracket (refer to table on page 63).

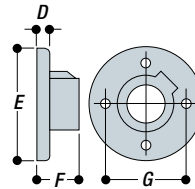

TYPE	Pipe ref.	in.						lb.
		A	D	E	F	G	Ø	
60-5	5	0.55	5.12	2.52	3.11	0.31		2.54
60-6	6	0.55	5.51	2.52	3.39	0.31		2.54
60-7	7	0.55	5.87	2.52	3.74	0.31		2.87
60-8	8	0.55	6.18	2.52	4.02	0.31		3.26

Ø indicates the diameter of the fixing hole.

WARNING: This component is not recommended for use as a base flange to support guardrail or balustrades (see Type 62).

61

Flange

Frequently used as a wall fixing bracket (refer to table on page 63). Used on structures where the fixing required is positional only. Holes provided for countersunk flathead screw fixings only.

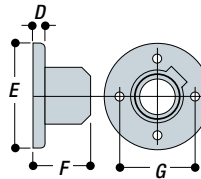

TYPE	Pipe ref.	in.						lb.
		A	D	E	F	G	Ø	
61-3	3	0.25	2.76	1.26	1.85	0.26		0.42
61-4	4	0.25	3.07	1.54	2.13	0.26		0.51
61-5	5	0.25	3.15	1.57	2.24	0.26		0.73
61-6	6	0.25	3.54	1.93	2.52	0.26		1.10
61-7	7	0.25	4.02	2.01	2.99	0.31		1.37
61-8	8	0.25	4.53	2.32	3.50	0.31		1.48
61-9	9	0.39	5.00	2.48	3.74	0.39		2.38

Ø indicates the diameter of the fixing hole.

WARNING: This component is not recommended for use as a base flange to support guardrail or balustrades (see Type 63).

62

Standard Railing Flange

Ideal when a structural fixing is required for guard rail and balustrades. The holes are of sufficient diameter to ensure proper fixing with either a mechanical or chemical anchor. The two set screws in the vertical socket give greater side-load stability to the upright. It is recommended that the fixing holes in the flange should be in line with the applied load (refer to table on page 63).

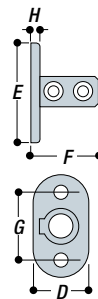

TYPE	Pipe ref.	in.						lb.
		A	D	E	F	G	H	
62-5	5	2.56	4.57	3.11	2.99	0.24	0.43	1.30
62-6	6	2.99	5.04	3.50	3.50	0.31	0.55	1.61
62-7	7	2.99	5.51	3.54	4.02	0.43	0.55	2.87
62-8	8	3.34	6.10	3.50	4.53	0.39	0.55	2.86
62-9	9	4.02	6.50	5.00	5.00	0.39	0.71	3.88

Ø indicates the diameter of the fixing hole.

63

Angle Base Flange (45°-60°)

Similar to Type 62, but used to set up the upright at an angle between 45° to 60°. This component should only be subjected to light loads which cannot be positioned at 90° to the applied load. For greater loads or other pipe sizes, a Type 62 flange is used and the upright bent to the required angle (refer to table on page 63).

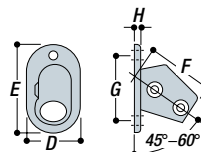

TYPE	Pipe ref.	in.						lb.
		A	D	E	F	G	H	
63-6	6	3.07	5.12	3.62	3.78	0.31	0.55	2.16
63-7	7	2.99	5.43	3.74	4.17	0.39	0.55	2.54
63-8	8	3.54	6.10	3.94	4.53	0.39	0.55	3.31

Ø indicates the diameter of the fixing hole.

Kee Lite Aluminum version available

64

Standard Vertical Railing Flange

For fixing guardrail and balustrades to walls, parapets, steps, and ramps. The upright cannot drop through the socket. The max. length of top bolt (inc. the head) must not exceed 1", also applies to projecting fixed studs (refer to table on page 63).

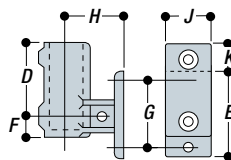

Note: Should an upright be required to pass through the component, the base can be bored out to order.

TYPE	Pipe ref.	in.							lb.	
		A	D	E	F	G	H	J		K
64-6	6	3.43	3.74	0.83	2.64	2.24	1.77	1.57	0.55	1.70
64-7	7	3.31	4.25	1.18	2.83	2.56	2.01	1.38	0.55	2.47
64-8	8	3.90	4.76	0.87	3.50	2.76	2.20	0.98	0.55	3.40

Ø indicates the diameter of the fixing hole.

*Refer to table on page 63.

65

Standard Horizontal Railing Flange

This component is designed for palm fixing guardrailing and balustrading to walls, parapets, steps and ramps. The upright cannot drop through the socket (refer to table on page 63).

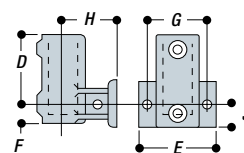

Note: Should an upright be required to pass through the component, the base can be bored out to order.

TYPE	Pipe ref.	in.							lb.
		A	D	E	F	G	H	J	
65-6	6	3.27	3.86	0.87	2.64	2.24	0.87	0.55	1.68

Ø indicates the diameter of the fixing hole.

66

Ground Socket

A ground socket component for setting in concrete. The posts may either be permanent or removable as required. It incorporates a socket set screw fixing and can be supplied with a plug to fill the hole when the pipe is removed (refer to table on page 63).

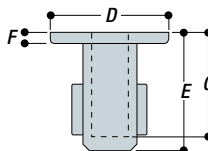

TYPE	Pipe ref.	in.				lb.
		A	D	E	F	
66-6	6	5.00	4.84	0.43	4.53	4.12
66-7	7	5.51	5.35	0.43	5.00	5.12
66-8	8	5.51	5.35	0.43	5.00	5.51

67

Angle Flange

Type 67 has been designed to allow the upright to pivot in the barrel, providing an angular displacement from 3° up to a maximum of 11°, measured from the vertical. Ideal to secure balustrade and guardrail systems on access ramps or other types of slopes (refer to table on page 63).

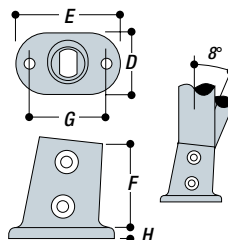

Note: It is generally recommended that, when installing the 67-8, the fixing holes in the base should be in line with the applied load.

TYPE	Pipe ref.	in.						lb.
		A	D	E	F	G	H	
67-7	7	3.27	5.51	3.11	4.01	0.35	0.55	2.49
67-8	8	3.78	5.98	3.54	4.49	0.35	0.55	2.87

Ø indicates the diameter of the fixing hole.

68

Wall Flange

Side fixing for guardrailing and balustrading to walls, parapets, steps and ramps. The upright cannot drop through the socket (refer to table on page 63).

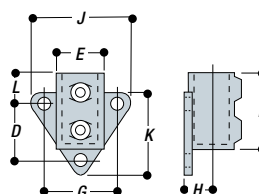

Note: If the upright is required to pass through the component by machining out the base stop, the bottom fixing hole will be unusable.

TYPE	Pipe ref.	in.						lb.
		A	D	E	F	G	H	
69-6	6	2.48	1.77	3.03	2.80	0.94	1.37	
		J	K	L	Ø			
69-7	7	3.75	4.06	1.00	0.43		1.76	
		D	E	F	G	H		
69-7	7	2.83	2.09	3.27	3.27	1.10	1.76	
		J	K	L	Ø			
69-8	8	4.19	4.25	1.00	0.43		2.09	
		D	E	F	G	H		
69-8	8	3.07	2.36	3.50	3.39	1.22	2.09	
		J	K	L	Ø			
69-8	8	4.44	4.56	1.00	0.43		2.09	
		D	E	F	G	H		

Ø indicates the diameter of the fixing hole.

69

Railing Flange with Toeboard Adaptor

For guardrail and balustrade applications with added toeboard at base. Base plate holes have sufficient diameter to allow for attachment with either a mechanical or chemical anchor. Side plates have slotted holes to allow for a degree of sideways movement for ease of installation (refer to table on page 54).

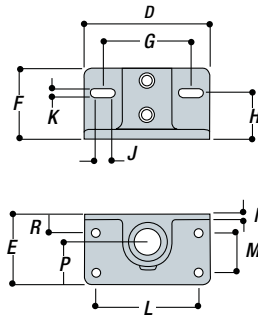

TYPE	Pipe ref.	in.							lb.
		A	D	E	F	G	H	J	
69-6	6	5.12	2.95	3.07	3.74	2.28	0.59	0.39	3.76
		L	M	N	P	R	Ø		
69-7	7	3.94	1.38	0.28	1.77	1.00	0.43		4.32
		D	E	F	G	H	J	K	
69-8	8	5.71	3.15	3.54	3.82	2.28	0.79	0.39	5.07
		L	M	N	P	R	Ø		
		6.30	3.54	3.54	4.41	2.28	0.79	0.39	
		L	M	N	P	R	Ø		
		5.12	1.97	0.28	2.13	1.00	0.43		
		L	M	N	P	R	Ø		

Ø indicates the diameter of the fixing hole.

70

Rail Support

Designed to carry handrails along walls or to fix structures back to walls. The pipe passes through the component and cannot be used as a coupling. The Type 70 is also used to attach toeboards to the base of guardrail uprights. Holes provided for countersunk flat head screw fixings only.

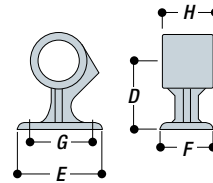

TYPE	Pipe ref.	in.						lb.
		A	D	E	F	G	H	
70-5	5	2.17	3.07	1.81	2.24	1.18	0.31	0.79
70-6	6	2.28	3.46	1.57	2.76	1.18	0.31	0.97
70-7	7	2.52	4.02	1.81	3.00	1.34	0.31	1.23
70-8	8	2.76	4.25	2.05	3.38	1.34	0.31	1.72

Ø indicates the diameter of the fixing hole.

WARNING: Type 70 components are not designed to be used as base flanges for full height guardrails or handrails.

71

Weather Cap

Designed for roof guardrailing to ensure a weathertight seal for base flanges. The weather cap is secured to the upright by means of a combined sealant adhesive. A separate information sheet detailing fixing instructions is available on request.

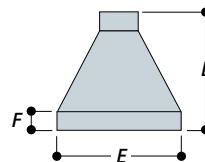

TYPE	Pipe ref.	in.			lb.
		A	D	E	
71-6	6	4.92	5.93	0.98	0.53
71-7	7	5.91	6.06	0.98	0.71
71-8	8	6.10	6.57	0.98	0.79

Ø indicates the diameter of the fixing hole.

72

Stair Tread Support

Suitable for most types of stair tread, including timber, open steel and checker plate. Fixing of the tread is by two bolt holes in each component.

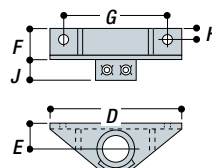

TYPE	Pipe ref.	in.							lb.
		A	D	E	F	G	H	J	
72-8	8	7.99	1.54	2.01	5.98	0.75	1.30	0.43	2.76

Ø indicates the diameter of the fixing hole.

WARNING: If Type 72 components are to be used for a permanent application or subjected to high loads, the stair tread support pipe which is located at its ends with a single set screw, should be drilled and pinned to avoid rotational slip.

75

Collar

Commonly used to support another component if the latter is required to be left untightened, such as gate hinges. Type 75 also provides additional support when the loading on a structure exceeds the maximum permitted slip load for a socket set screw.

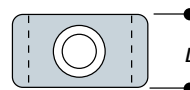

TYPE	Pipe ref.	in.	lb.
		D	
75-4	4	0.91	0.11
75-5	5	1.02	0.29
75-6	6	1.02	0.29
75-7	7	1.02	0.33
75-8	8	1.02	0.42

Ø indicates the diameter of the fixing hole.

76

Hook

A component normally used for attachment of chains.

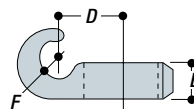

TYPE	Pipe ref. A	in.			lb.
		D	E	F	
76-5	5	1.18	1.06	0.35	0.37
76-6	6	1.38	1.06	0.51	0.46
76-7	7	1.50	1.06	0.51	0.51
76-8	8	1.61	1.06	0.51	0.53

133

Plastic Plug

A grey plastic plug to fit open ended pipes. Suitable for medium and heavy piping only. For an alternative in metal, see Type 84.



TYPE	Pipe ref. A	in.	lb.
133A	5		0.009
133B	6		0.015
133C	7		0.035
133D	8		0.044
133E	9		0.05

78

Eye Fitting

Used in conjunction with Type 83 component for gate hinges.

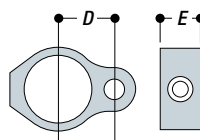

TYPE	Pipe ref. A	in.			lb.
		D	E	Ø	
78-5	5	1.18	1.02	0.46	0.46
78-6	6	1.30	1.02	0.55	0.55
78-7	7	1.50	1.02	0.57	0.57
78-8	8	1.61	1.02	0.62	0.62

Ø indicates the diameter of the fixing hole.

79

Sheeting Clip

This component is used to attach profiled sheeting material to pipe. The component is supplied with the following hardware: one M6 x 2" roofing bolt, one M6 square nut, and one M6 lock washer. BZP finish.

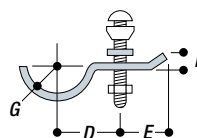

TYPE	Pipe ref. A	in.					lb.
		D	E	F	G	Ø	
79-7	7	1.81	1.34	0.31	0.83	0.31	0.18

Ø indicates the diameter of the fixing hole.

81

Single Sided Clip

For attaching wire mesh infill. For economy, it is possible to use Type 81 clips without the safety attachment to secure various types of infill panels (plyboard, perspex, etc.) up to a thickness of 25/64". All clips are supplied with hexagonal head fixing bolts, M6 x 1.38" long and nut. The primary clip has a slot measuring 0.31" x 0.59".

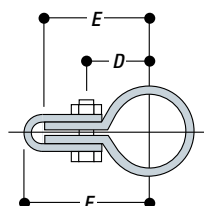
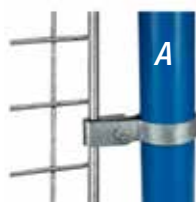

Note: For D and E dimensions the figures are given for the respective minimum and max. dimensions allowed by the slotted hole.

TYPE	Pipe ref. A	in.				lb.
		D	E	F	Ø	
81-5	5	0.94	1.77	2.20	0.28	0.15
81-6	6	1.06	2.05	2.32	0.28	0.18
81-7	7	1.26	2.24	2.52	0.28	0.18
81-8	8	1.34	2.32	2.60	0.28	0.20
81-9	9	1.57	2.56	2.83	0.28	0.22

Ø indicates the diameter of the fixing hole.

82

Double Sided Clip

For attaching wire mesh infill. For economy it is possible to use Type 82 clips without the safety attachment, to secure various types of infill panels (plyboard, perspex, etc.) up to a thickness of 25/64". All clips are supplied with hexagonal head fixing bolts, M6 x 1.38" long, and nut. The primary clip has a slot measuring 0.32" x 0.59".

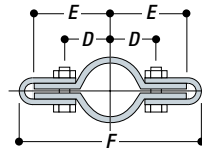
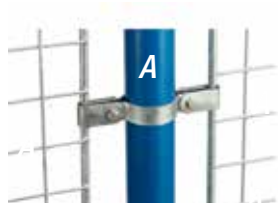

Note: For D and E dimensions the figures are given for the respective minimum and max. dimensions allowed by the slotted hole.

TYPE	Pipe ref.	in.				lb.
		A	D	E	F	
82-5	5	0.94	1.77	4.41	0.28	0.24
82-6	6	1.06	2.05	4.65	0.28	0.26
82-7	7	1.26	2.24	5.04	0.28	0.29
82-8	8	1.34	2.32	5.20	0.28	0.31
82-9	9	1.57	2.56	5.67	0.28	0.31

∅ indicates the diameter of the fixing hole.

83

Pin Fitting

This component is used in conjunction with Type 78 for gate hinges.

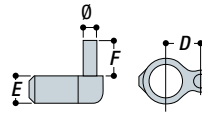

TYPE	Pipe ref.	in.				lb.
		A	D	E	F	
83-5	5	1.18	1.02	1.50	0.51	0.44
83-6	6	1.30	1.02	1.50	0.51	0.55
83-7	7	1.50	1.02	1.50	0.51	0.64
83-8	8	1.61	1.02	1.50	0.51	0.66

∅ indicates the diameter of the fixing hole.

84

Malleable Plug

A metal drive-in plug which is difficult to remove when installed. For an alternative in plastic, see Type 77.



TYPE	Pipe ref.		lb.
	A		
84-5	5		0.11
84-6	6		0.22
84-7	7		0.26
84-8	8		0.37
84-9	9		0.64

Note: This component can only be used with EN 10255 (ISO 65) medium weight piping.



The Slope Range (86-89)

The slope range of components consists of component Types 67, 86, 87, 88, 89. These components are designed to facilitate in-line railings with vertical posts on slopes with angles between 0° and 11°. They can be used to construct railings on access ramps for people with disabilities when used in conjunction with the Kee Klamp access range (see page 58).

86

Angle Tee (0°-11°)

Used to join the middle rail to an upright on a guardrail on a slope from 0° to 11°.

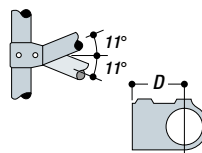

TYPE	Pipe ref.	in.		lb.
		A	D	
86-7	7		2.36	1.25
86-8	8		2.68	1.68

87

Angle Elbow (0°–11°)

Used to join the top-rail to an end upright on a guardrail on a slope from 0° to 11°.

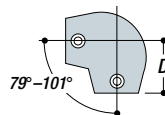
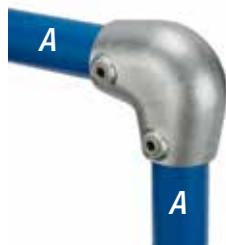

TYPE	Pipe ref.		in.		lb.
	A	D	D		
87-7	7		2.36		1.80
87-8	8		2.68		1.98

88

Three Socket Angle Tee (0°–11°)

Used to join the top-rail to an intermediate upright on a guardrail on a slope from 0° to 11°. As there are two socket set screws in the sleeve, this component can be used to join two pipes.

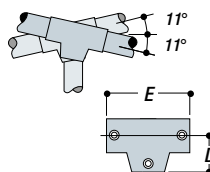
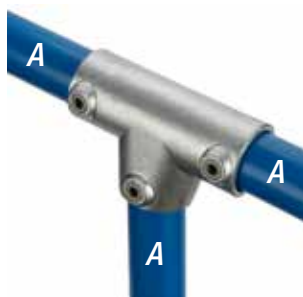

TYPE	Pipe ref.		in.		lb.
	A	D	E		
88-7	7	2.36	5.67		2.16
88-8	8	2.68	6.22		2.73

89

Two Socket Angle Cross (0°–11°)

Used to join the middle rail to an intermediate upright on a guardrail on a slope from 0° to 11°. The upright passes through the component.

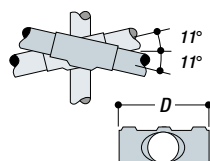
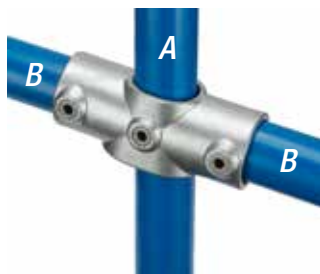

TYPE	Pipe ref.		in.		lb.
	A	B	D		
89-7	7	7	5.67		1.62
89-8	8	8	6.22		2.05
89-87	8	7	6.10		1.67

The PGR Range (90–95)

These are known as Pedestrian Guardrail (PGR) components and are used as an alternative to Types 10, 15, 25 and 26 when the site is not straight and level. There is sufficient play within the component to negotiate a slope up to 7 degrees or a radius greater than 6 metres, when the uprights are 2 metre centers, using straight pipe. They also allow damaged rails to be removed without dismantling the adjacent structure. The 90 to 95 range of components is available in size 8.

90

PGR Three Socket Tee

Type 90 is used to join the top-rail to an intermediate upright.

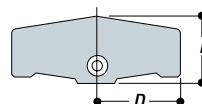

TYPE	Pipe ref.		in.		lb.
	A	D	E		
90-8	8	3.90	3.46		3.90

91

PGR Two Socket Cross

Type 91 is used to join the mid-rail to an intermediate upright.

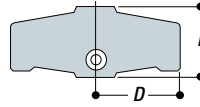
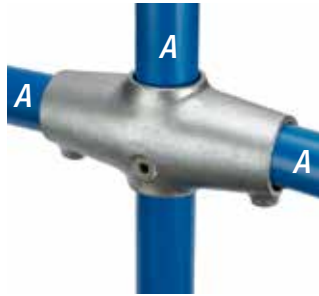

TYPE	Pipe ref.	in.			lb.
	A	D	E		
91-8	8	3.90	3.50		3.97

92

PGR Elbow

Type 92 is used to join the top-rail to an end post.

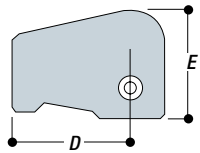
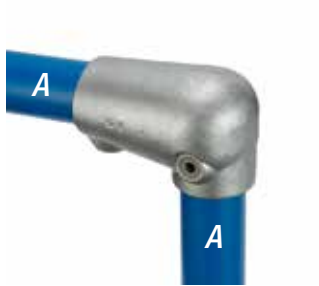

TYPE	Pipe ref.	in.			lb.
	A	D	E		
92-8	8	3.90	3.50		2.84

93

PGR Tee

Type 93 is used to join the mid-rail to an end post.

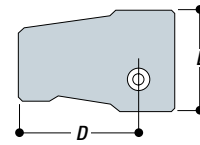
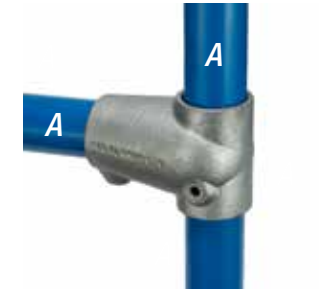

TYPE	Pipe ref.	in.			lb.
	A	D	E		
93-8	8	3.90	3.50		2.65

95

PGR Internal Spigot

Internal spigot designed to prevent sagging of bends when using the 90 to 95 range of components.

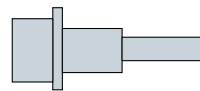

TYPE	Pipe ref.	in.			lb.
	A	D	E		
95-8	8				1.01

105

Sheeting Clip without Hardware

This clip is used to attach profiled or flat sheeting. It is supplied with fixings.

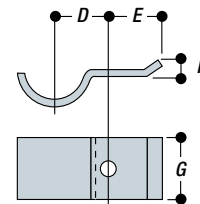

TYPE	Pipe ref.	in.					lb.
		A	D	E	F	G	
105-6	6	1.26	1.57	0.51	1.97	0.35	0.31
105-7	7	1.50	1.57	0.51	1.97	0.35	0.35
105-8	8	1.57	1.57	0.51	1.97	0.35	0.40
105-9	9	1.89	1.57	0.51	1.97	0.35	0.51

Ø indicates the diameter of the fixing hole.

Note: For use where fixing required is positional only. Clip is not intended to bear substantial load.

114

Swivel Tee

An internal swivel component, designed to accommodate varying angles on handrailing to staircases, ramps or bracing. Used in conjunction with Types 10, 15, 25 or 45.

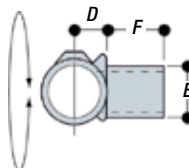
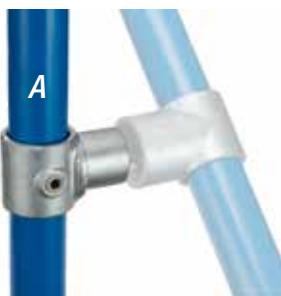

TYPE	Pipe ref.	in.			lb.
	A	D	E	F	
114-6	6	0.83	1.34	1.14	0.79
114-7	7	1.02	1.65	1.42	1.19
114-8	8	1.14	1.93	1.61	1.41

115

Horizontal Railing Flange

Type 115 is designed for palm fixing of guardrail and balustrades to walls, parapets, steps and ramps. The upright cannot drop through the socket. Packer plates, Type S115, are available to allow the component to be positioned in channels, slots and other offset areas.

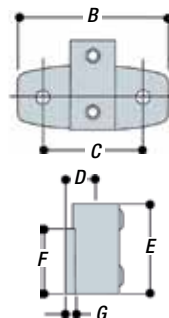

TYPE	Pipe ref.	in.						lb.	
	A	B	C	D	E	F	G		Ø
115-6	6	5.91	3.94	1.18	3.54	2.56	0.39	0.55	2.34
115-7	7	5.91	3.94	1.38	3.54	2.56	0.39	0.55	2.71
115-8	8	5.91	3.94	1.61	3.54	2.56	0.39	0.55	3.13

Ø indicates the diameter of the fixing hole.

S115

Packer Plate for Type 115

Type S115 allows the Type 115 component to be positioned in channels, slots and other offset areas.

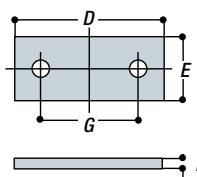

TYPE	in.				lb.
	D	E	F	G	
S115	5.90	2.56	0.47	3.94	1.92

Ø indicates the diameter of the fixing hole.

118

Cover Flange

This component slips over uprights to finish below ground post installations. The component is secured to the upright pipe with a single recessed set screw.

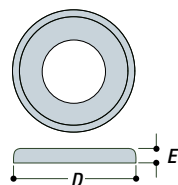

TYPE	Pipe ref.	in.		lb.
	A	D	E	
118-8	8	4.00	0.60	0.88

121

Corner Crossover

This component is designed to provide a 90° offset corner joint. This component is typically used with the Type 45 and Type 145 crossover components to built and offset railing.

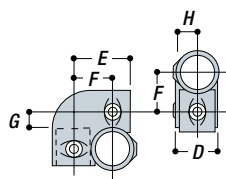
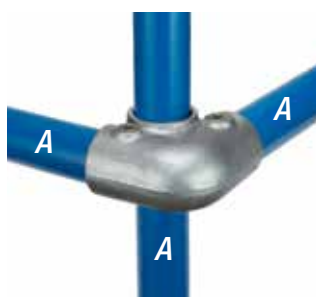

TYPE	Pipe ref.	in.					lb.
	A	D	E	F	G	H	
121-7	7	1.81	2.83	1.93	0.87	0.98	2.03

Note: To obtain the true height of the upright the allowance for the base components must be included.

145

Crossover Coupling

Designed to give a 90° offset crossover. With two socket set screws in the sleeve, this Kee Klamp component can be used where a join is required in the horizontal pipe.

For economy, it is possible to use a Type 45 in place of the 145, using the 145 only where a join in the pipe occurs.

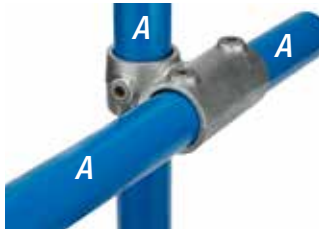

Note: To obtain the true height of the upright the allowance for the base components must be included.

TYPE	Pipe ref.	in.					lb.
		A	D	E	F	G	
145-7	7	1.81	4.02	1.93	0.91	1.83	

199

Single Offset Fixing Bracket

The Type 199 is used as an attachment point for flat sheets or boards and comes supplied with a drilled hole.

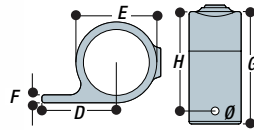

TYPE	Pipe ref.	in.						lb.
		A	D	E	F	G	H	
199-6	6	1.77	2.87	0.20	2.38	0.98	0.33	0.594
199-7	7	2.09	3.17	0.24	2.09	1.57	0.24	0.792
199-8	8	2.20	3.41	0.24	2.20	1.57	0.24	0.792

Ø indicates the diameter of the fixing hole.

200

Double Offset Fixing Bracket

The Type 200 is used as an attachment point for flat sheets or boards and comes supplied with a drilled hole.

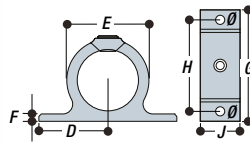

TYPE	Pipe ref.	in.							lb.
		A	D	E	F	G	H	J	
200-6	6	1.77	1.77	0.20	3.54	2.75	1.00	0.25	0.40
200-7	7	2.09	2.16	0.25	4.17	3.38	1.57	0.45	0.84
200-8	8	2.20	2.64	0.25	4.41	3.62	1.57	0.45	1.30

Ø indicates the diameter of the fixing hole.

262

Round Base Flange

The Round Base Flange features a single fixing hole. The hole is hidden to create a more aesthetic look. The two set screws in the vertical socket give greater upright stability.

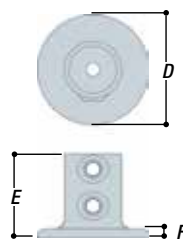

TYPE	Pipe ref.	in.				lb.
		A	D	E	F	
262-8	8	4.57	3.50	0.39	0.55	2.12

Ø indicates the diameter of the fixing hole.

265

Offset All Wall Flange

Side fixing for guardrail and balustrades to walls, parapets, steps and ramps. Upright cannot drop through the socket. Designed for installations of rail that are offset from which it is being fixed.

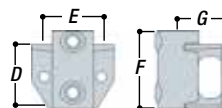

TYPE	Pipe ref.	in.					lb.
		A	D	E	F	G	
265-7	7	3.39	2.99	4.09	2.60	0.55	2.98
265-8	8	3.39	3.55	4.69	2.91	0.55	3.48

Ø indicates the diameter of the fixing hole.

Keel Lite Aluminum version available

316

Parapet Flange

Designed to retrofit onto roof parapets that are at an unsafe height. Upright pipe is angled 25 degrees from the vertical so that the building's visage is unaffected by the installed guardrailing. Two holes are located in the top mounting bracket for fixing directly into the parapet. The two set screws in the vertical socket give greater side-load stability to the angled upright. Engineered weep hole allows water to drain.

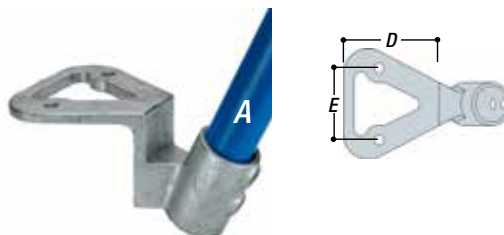

TYPE	Pipe ref.	in.			lb.
	A	D	E	Ø	
316-7	7	5.35	4.25	0.55	4.21
316-8	8	5.42	4.25	0.55	4.52

Ø indicates the diameter of the fixing hole.

The Slope Range (320-427)

This slope range of components is designed specifically for use on steeper gradients and consists of component Types 320, 321, 325, 326, 427. These components are designed to facilitate in-line railings with vertical posts where the slope is greater than 30°.

320LH

Left hand level to Sloping Down Side Outlet Elbow (30°-45°)

Left Hand Side Outlet Elbow component designed for the top-rail on guardrail on slopes and staircases between 30° and 45° at the junction where the handrail changes from level to sloping down the stairs.

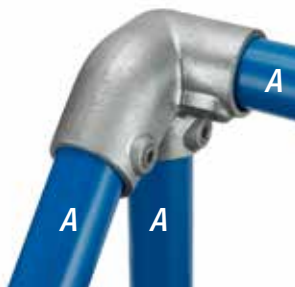

TYPE	Pipe ref.	in.			lb.
	A	D	E	F	
320LH-7	7	3.38	2.36	1.14	2.38
320LH-8	8	3.66	2.68	1.26	2.82

Note: handing perspective for Kee Klamp is looking DOWN the staircase.

320RH

Right hand level to Sloping Down Side Outlet Elbow (30°-45°)

Right Hand Side Outlet Elbow component designed for the top-rail on guardrail on slopes and staircases between 30° and 45° at the junction where the handrail changes from level to sloping down the stairs.

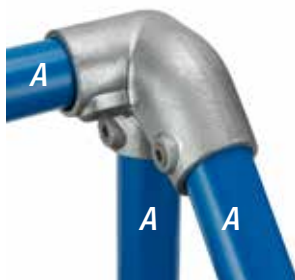

TYPE	Pipe ref.	in.			lb.
	A	D	E	F	
320RH-7	7	3.38	2.36	1.14	2.38
320RH-8	8	3.66	2.68	1.26	2.82

Note: handing perspective for Kee Klamp is looking DOWN the staircase.

321LH

Left hand level to Sloping Down Side Outlet Tee (30°-45°)

Left Hand Side Outlet Tee component designed for the mid-rail on guardrail on slopes and staircases between 30° and 45° at the junction where the handrail changes from level to sloping down the stairs.

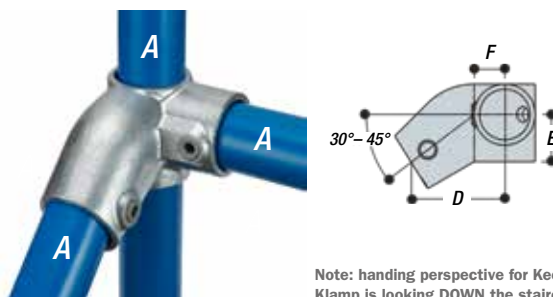

TYPE	Pipe ref.	in.			lb.
	A	D	E	F	
321LH-7	7	3.38	1.06	1.14	2.11
321LH-8	8	3.62	1.18	1.26	2.46

Note: handing perspective for Kee Klamp is looking DOWN the staircase.

321RH

Right hand level to Sloping Down Side Outlet Tee (30°–45°)

Right Hand Side Outlet Tee component designed for the mid-rail on guardrail on slopes and stair-cases between 30° and 45° at the junction where the handrail changes from level to sloping down the stairs.

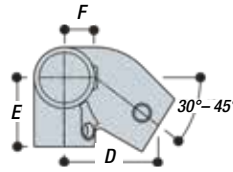
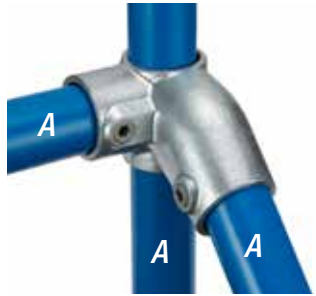

Note: handing perspective for Kee Klamp is looking DOWN the staircase.

TYPE	Pipe ref.	in.			lb.
	A	D	E	F	
321RH-7	7	3.38	1.06	1.14	2.11
321RH-8	8	3.62	1.18	1.26	2.46

325

Level to Sloping Down Tee (30°–45°)

Tee component designed for the top-rail on guardrail on slopes and staircases between 30° and 45° at the junction where the handrail changes from level to sloping down the stairs.

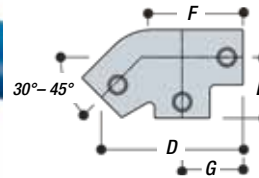
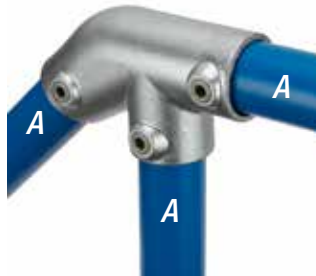

TYPE	Pipe ref.	in.				lb.
	A	D	E	F	G	
325-7	7	5.59	2.36	3.50	2.36	2.24
325-8	8	6.06	2.68	3.94	2.68	2.46

325A

Level to Sloping Up Tee (30°–45°)

Tee component designed for the top-rail on guardrail on slopes and staircases between 30° and 45° at the junction where the handrail changes from level to sloping up the stairs.

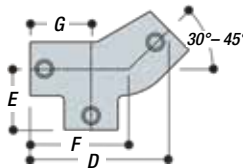
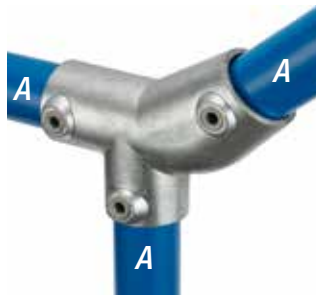

TYPE	Pipe ref.	in.				lb.
	A	D	E	F	G	
325A-7	7	5.59	2.36	3.50	2.36	2.24
325A-8	8	6.06	2.68	3.94	2.68	2.46

326

Level to Sloping Down or Up Cross (30°–45°)

Level to Sloping Down or Up Cross (30°–45°) Cross component designed for the mid-rail on guardrail on slopes and staircases between 30° and 45° at the junction where the handrail changes from either level to sloping down or level to sloping up the stairs.

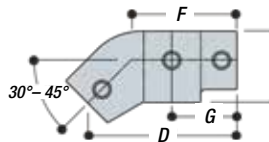
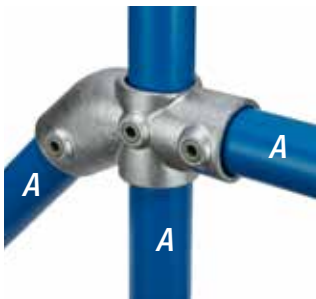

TYPE	Pipe ref.	in.				lb.
	A	D	E	F	G	
326-7	7	5.59	2.68	3.50	2.36	1.80
326-8	8	6.06	2.91	3.94	2.68	2.09

327

Three Socket Tee (11°–30°)

This component is used on safety railing with slopes between 11°–30° and fixes the top-rail to a vertical intermediate upright.

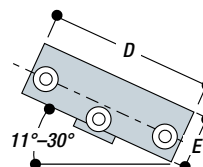
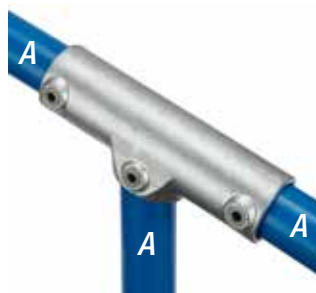

TYPE	Pipe ref.	in.		lb.
	A	D	E	
327-7	7	7.08	2.16	2.42
327-8	8	8.50	2.36	3.08

328

Two Socket Cross (11°–30°)

This component is used on safety railing with slopes between 11°–30° and fixes the mid-rail to a vertical intermediate upright.

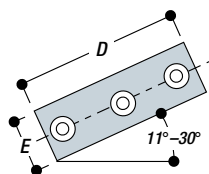
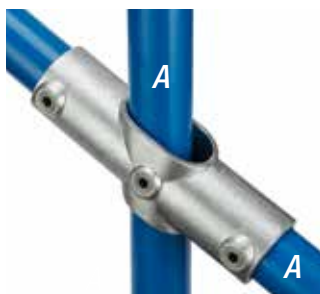

TYPE	Pipe ref.	in.		lb.
	A	D	E	
328-7	7	7.08	2.16	2.35
328-8	8	8.50	2.36	2.64

329

Single Socket Tee (11°–30°)

Designed as an alternative to Type 12, this adjustable component is most frequently used for bracing and struts and for terminating the mid-rail on sloping guardrails into the end upright. It may be used at any selected angle between 11° and 30°.

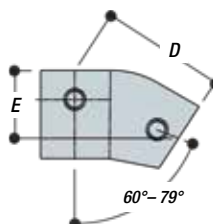
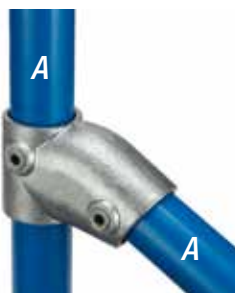

TYPE	Pipe ref.	in.		lb.
	A	D	E	
329-7	7	3.90	2.13	1.61
329-8	8	4.29	2.32	1.89

350

Eaves Fitting

The Type 350 component has been designed for small structural building applications and provides for significant load rating. When used with the Type 351 ridge component a truss arrangement for additional support can be achieved. Double set screws are provided on the truss outlet to provide additional pull out resistance to hold structures firmly together.

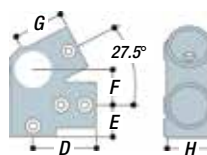
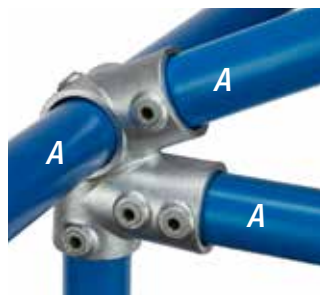

TYPE	Pipe ref.	in.					lb.
	A	D	E	F	G	H	
350-8	8	3.27	1.65	1.85	2.64	2.36	2.62

351

Ridge Fitting

Designed for small structural building applications and provides for significant load rating. When used with the Type 350 eaves component a truss arrangement for additional support can be achieved. Double set screws are provided on the downward truss outlet to provide additional pull out resistance and extra strength to the structure.

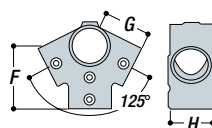
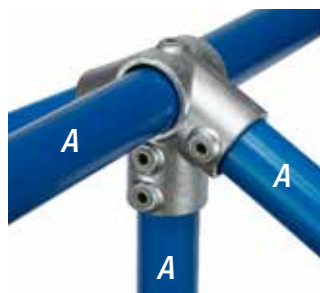

TYPE	Pipe ref.	in.			lb
	A	F	G	H	
351-8	8	3.50	2.64	2.36	2.11

363

Angle Base Flange (11°–30°)

Similar to a type 63, it is used to set the upright at an angle between 11°–30°. This component should only be subjected to light loads which cannot be positioned at 90° to the applied load. For greater loads or other pipe sizes a Type 62 flange should be used with the upright bent to the required angle.

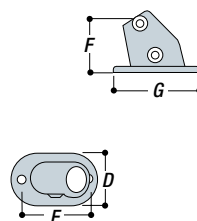

TYPE	Pipe ref.	mm					Kg
	A	D	E	F	G	∅	
363-7	7	2.99	4.49	3.35	5.75	0.55	2.156
363-8	8	3.50	4.88	3.74	6.46	0.55	2.882

∅ indicates the diameter of the fixing hole.

427

Three Socket Tee (30°–45°)

This component is used on a safety railing with slopes between 30° and 45° and fixes the top-rail to a vertical intermediate upright.

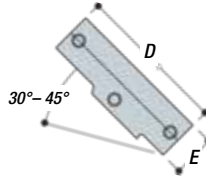
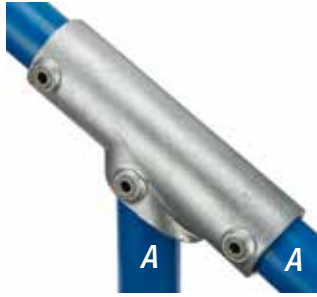

TYPE	Pipe ref.	in.		lb.
	A	D	E	
427-7	7	7.09	2.17	2.09
427-8	8	8.50	2.36	2.684

623

High Capacity Base Flange

A heavy duty base component for railings in areas that are prone to overcrowding, including stadiums, grandstands, theatres, cinemas, shopping malls and urban footpaths. It has been designed for railings that need to resist loadings of up to 206lb/ft applied at the top-rail.

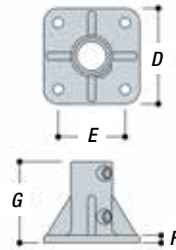

TYPE	Pipe ref.	in.				lb.
	A	D	E	F	G	
623-8	8	6.02	4.06	0.47	5.51	8.998
623-9	9	6.50	4.53	0.51	5.51	8.184

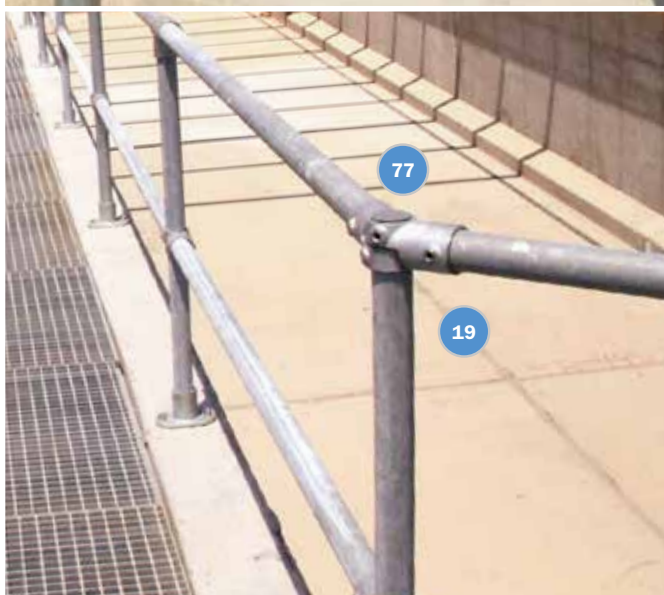

Kee Klamp®

Access Safety Components

The Kee Klamp access range of tubular components are designed specifically to meet the requirements of the Americans with Disabilities Act (ADA), as well as state and local building codes. The components provide a cost-effective solution for handrail installations on both new and refurbishment projects.

The Kee Klamp access range of components have been designed to create a smooth handrail with size 7 pipe (outside diameter 1.25"). All components can be powder coated in a choice of RAL colors to meet the visibility and 'not cold to the touch' requirements of the building regulations.



ENGINEERING

The modular components are designed to suit ASTM A53 steel pipes. Components are made of Galvanized cast iron to ASTM A123 for long-term maintenance; they are also available with polyester coating in any RAL color.

Any Kee Klamp access railing system can be easily installed with a hex tool and pipe cutters, and is therefore easily assembled without specialised workers or equipment, saving you both time and money.

10-840C

Single Handrail Socket Capped

Capped 90° socket tee designed for use at the termination of an upright where a handrail socket needs to be joined at the top of a post.

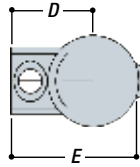
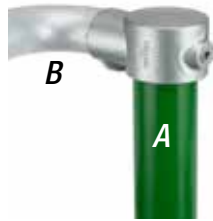

TYPE	Pipe ref.		in.		lb.
	A	B	D	E	
10-840C	8	stub	2.17	3.35	0.90

10-848

Single Handrail Socket

A 'tee' component which has a handrail socket. Typically used for attaching mid-rail supports to an upright. For upgrading size 7 and size 8 systems see A10-748 and A10-848.

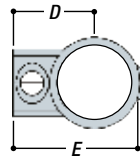
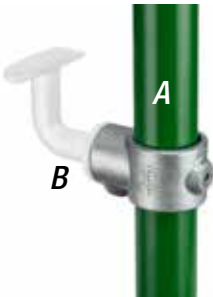

TYPE	Pipe ref.		in.		lb.
	A	B	D	E	
10-848	8	stub	2.17	3.35	0.84

A10-748

Add-on Single Handrail Socket

The hinge and pin system of this socket tee enables existing structures to be easily modified without the need for dismantling. Hinges around existing size 7, or 1-1/4" N.B. pipe.

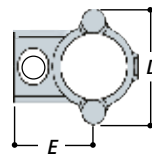
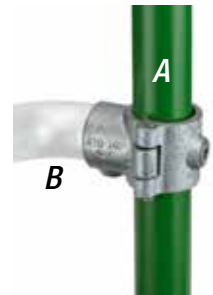

TYPE	Pipe ref.		in.		lb.
	A	B	D	E	
A10-748	7	stub	2.99	2.09	0.62

A10-848

Add-on Single Handrail Socket

The hinge and pin system of this socket tee enables existing structures to be easily modified without the need for dismantling. Hinges around existing size 8, or 1-1/2" N.B. pipe.

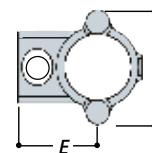
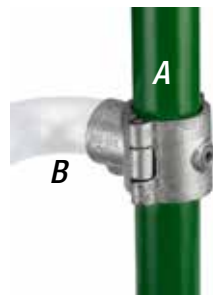

TYPE	Pipe ref.		in.		lb.
	A	B	D	E	
A10-848	8	stub	3.23	2.17	0.66

26-840

Twin Handrail Socket

Component slips over upright to create two handrail sockets at 90°.

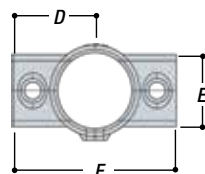
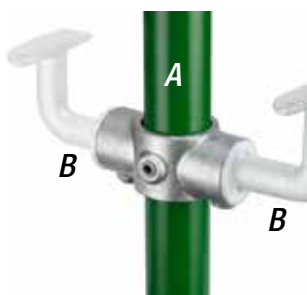

TYPE	Pipe ref.		in.			lb.
	A	B	D	E	F	
26-840	8	stub	2.17	1.89	4.33	0.97

26-840C

Twin Handrail Socket Capped

Capped component for use at the termination of an upright to create two handrail sockets at 90° from the upright.

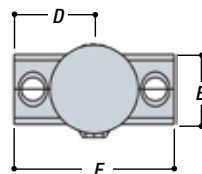

TYPE	Pipe ref.		in.			lb.
	A	B	D	E	F	
26-840C	8	stub	2.17	1.89	4.33	1.10

84-848

Upright Top Cap

A metal drive-in plug which is difficult to remove when installed. The 84-848 is a cap for the open ends of size 8 uprights and covers the top of a 10-848 tee component.



Note: This component can only be used with EN 10255 Medium Pipe.

508-7

Gap Washer (Optional)

A rubber gasket for use with size 7 components. Comes only in black.



514-7

Internal Coupling

Designed especially for DDA railing, this internal coupling can be powder coated (unlike the Type 18 component). The inset hex screw and precise coupling design allows handrail to be smooth and continuous. The internal coupling is a necessary component when installing Type 520-7, Type 554-7, Type 565-7 and Type 567-7.

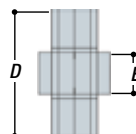

TYPE	Pipe ref.		in.		lb.
	A		D	E	
514-7	7		2.93	1.00	0.84

515-7

Split Elbow (90°)

This elbow consists of two separate pieces that are joined by a central screw. The component is positioned with the ends inside the adjoining handrails, and the outer grub screws tightened. This forces the halves apart, gripping the inside of the pipe. The central screw is then tightened, locking the component in place.

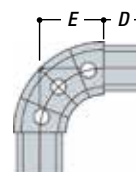

TYPE	Pipe ref.		in.		lb.
	A		D	E	
515-7	7		1.34	1.97	1.85

518-7

Handrail Bracket

An intermediate upright handrail support. This bracket is designed to be mounted into a socket component. The rail sits on the saddle and is secured by either Ø 0.19" x 0.59" long Aluminum multi-grip pop rivets or No. 10 x 0.75"

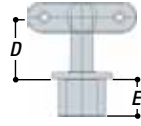
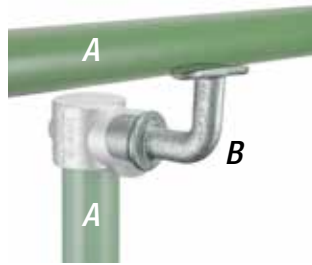

TYPE	Pipe ref.		in.			lb.
	A	B	D	E	Ø	
518-7	7	socket	2.01	1.18	0.20	1.08

Ø indicates the diameter of the fixing hole.

520-7

Solid Elbow (90°)

An alternative elbow to Type 515, two piece component. The elbow is designed to be joined to the handrails using two Type 514-7 internal couplings.

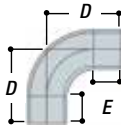

TYPE	Pipe ref.		in.		lb.
	A		D	E	
520-7	7		3.15	1.18	0.88

554-7

Variable Angle

A variable angle elbow for changes in elevation. This elbow allow for flexibility and a range of angles. The elbow is joined to rails using two Type 514-7 internal couplings.

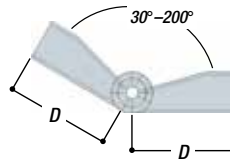

TYPE	Pipe ref.		in.		lb.
	A		D		
554-7	7		4.27		0.73

555-8

Top Fix Rail Bracket

An in-line, adjustable angle component for use where a handrail is mounted to the top of the upright. The saddle has a variable angle of 60° from the vertical.

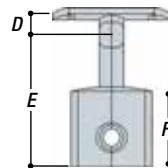
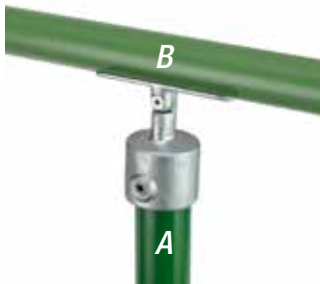

TYPE	Pipe ref.		in.				lb.
	A	B	D	E	F	Ø	
555-8	8	7	0.51	3.50	1.89	0.20	1.10

Ø indicates the diameter of the fixing hole.

561-7

Wall Frange

A wall mounted handrail end flange. Four fixing holes are drilled and countersunk to suit 1/4" diameter flat head wood screws. The handrail is joined to the flange with Type 514-7 Internal Coupling.

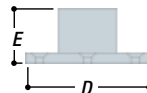

TYPE	Pipe ref.		in.			lb.
	A		D	E	Ø	
561-7	7		3.54	1.57	0.27	0.77

Ø indicates the diameter of the fixing hole.

565-7

Wall Mounted End Return

A wall mounted handrail return bracket. The bracket is joined to handrail using Type 514-7 coupling. Three fixing holes are drilled and countersunk to suit No. 14 countersunk screws.

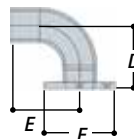

TYPE	Pipe ref.		in.				lb.
	A	D	E	F	Ø		
565-7	7	3.32	3.39	3.54	0.27	1.48	

Ø indicates the diameter of the fixing hole.

567-7

End Post Handrail Return

A handrail return bracket for use when mounting railing to an upright. This handrail is mounted to an upright using a handrail socket. Join the return handrail using Type 514-7 internal coupling.

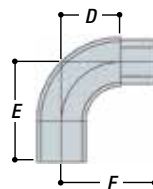
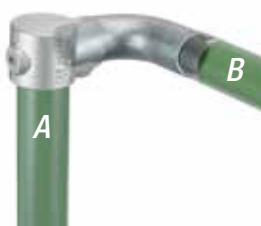

TYPE	Pipe ref.		in.			lb.
	A	B	D	E	F	
567-7	7	stub	2.01	3.39	3.19	1.08

570-7

Wall Mounted Handrail Bracket

A wall mounted version of the 518-7. The handrail pipe sits on the 'saddle' and is secured using either No. 10 self-drilling screws or multi-grip pop rivets. This bracket provides holes for countersunk head fixing screws only. Three fixing holes are drilled and countersunk to suit 1/4" diameter countersunk screws.

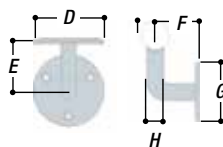

TYPE	Pipe ref.		in.					lb.	
	A	B	D	E	F	G	H		
570-7	7		3.46	2.48	3.23	3.54	1.00	0.25	1.47

Ø indicates the diameter of the fixing hole.

575-7

Upright Mounted Handrail Joiner

This bracket is designed to be mounted on a type 10-848, 26-840 or an A10-848 connecting two adjoining pipes without requiring pop rivets or self tapping screws. The inset setscrew and precise coupling design facilitates a smooth and continuous finished handrail.

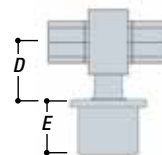
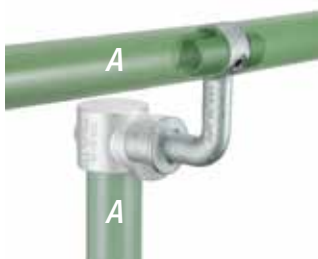

TYPE	Pipe ref.		in.		lb.
	A	D	E		
575-7	7	2.01	1.18		1.74

580-7

Wall Mounted Handrail Joiner

A wall mounted version of the 575-7, comprises of three countersunk woodscrew fixing holes and connects two adjoining handrail pipes without requiring pop rivets or self tapping screws. The inset setscrew and precise coupling design facilitates a smooth and continuous finished handrail.

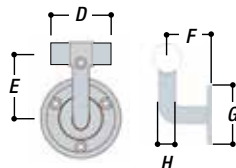

TYPE	Pipe ref.		in.					lb.
	A	D	E	F	G	H		
580-7	7	2.95	3.31	3.23	3.54	1.00	2.18	





Kee Lite®

Aluminum Safety Components

Kee Lite components are made from a high grade Aluminum Silicon Magnesium Alloy. They are strong yet light, and extremely durable – even in harsh environments. They are only one-third the weight of iron components, with about 75% of comparable tensile strength. Kee Lite components are designed to suit ASTM B221 pipe.



Kee Lite components offer flexibility and can be used in a variety of applications, from contemporary to industrial: your imagination is the only limitation.

Because Kee Lite can be easily installed with a hex tool and pipe cutters, there is no need for welding or specialist installation skills, saving you both time and money.

Kee Lite is securely locked into place using recessed set screws that provide a sleek and smooth look to your railing system. Kee Lite components are available for pipe sizes 25, 32, 40 and 50 N.B.

Component by Function

COUPLINGS

L14 Straight

CROSSES

L26 Two Socket

L30 Adjustable 11°–30°

L35 Three Socket

L40 Four Socket

L326 Level to Sloping Down or Up
30°–45°

CROSSOVERS

L45 Crossover

L46 Combination Socket Tee

ELBOWS

L15 90°

L20 Side Outlet

LB54 Adjustable

L55 Obtuse Angle

L55A Variable 30°–60°

L56 Acute Angle 30°–45°

L56A Acute Angle 11°–30°

L320LH Left Hand Level to Sloping
Down Side Outlet 30°–45°

L320RH Right Hand Level to Sloping
Down Side Outlet 30°–45°

FLANGES

LC58 Swivel

LM58 Double Swivel

L61 Male Double Swivel

L62 Male Corner Swivel

L63 Angle Base 45°–60°

L67 Angle

L68 Wall

L69 Railing Flange with
Toeboard Adaptor

L148 Heavy Duty Rectangular

L150 Heavy Duty Four Hole

L152 Four Hole Square

L164 Offset Wall

L262 Round Base

BRACKETS

L70 Rail Support

L160 Smooth Handrail Fitting

475 Aluminum Wall Bracket

PLUGS

77 Plastic

L84 Aluminum

COMBINATION SWIVELS

LC50 Single Combination

LF50 Female Single

LM50 Mail Single

LC51 Double Combination

LM51 Double Male

LC52 Corner Combination

LM52 Male Corner

TEES

L10 Single Socket

L19 Adjustable Side Outlet

L21 Side Outlet 90°

L25 Three Socket

L29 Single Socket 30°–60°

L46 Combination Socket Tee
and Crossover

L114 Swivel

L321LH Left Hand Level to Sloping
Down Side Outlet 30°–45°

L321RH Right Hand Level to Sloping
Down Side Outlet 30°–45°

L325 Level to Sloping Down
30°–45°

L325A Level to Sloping Up 30°–45°

L427 Three Socket 11°–30°

TOEBOARD KITS

TBI Toeboard

MISCELLANEOUS

Gaskets Neoprene Flange Gasket

L10

Single Socket Tee

This component creates a 90° perpendicular joint between two pipes.

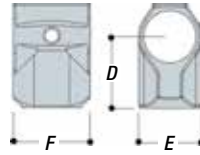
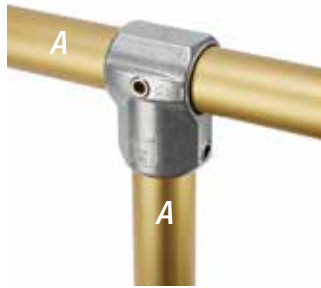

TYPE	Pipe ref.	in.			lb.
	A	D	E	F	
L10-6	6	2.05	1.67	2.20	0.29
L10-7	7	2.56	2.09	2.52	0.44
L10-8	8	2.91	2.36	2.76	0.66
L10-9	9	3.54	2.91	3.23	1.06

L14

Straight Coupling

Designed to give an in-line joint between pipes of the same size. Frequently used to enable full pipe lengths to be used in railing applications.

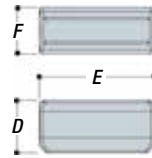

TYPE	Pipe ref.	in.			lb.
	A	D	E	F	
L14-6	6	1.97	3.94	1.67	0.40
L14-7	7	2.32	5.12	2.09	0.73
L14-8	8	2.56	5.83	2.36	0.82

Note: It is not advisable to join the upper and lower rails of a railing within the same bay.

L15

Elbow (90°)

A 90° elbow joint, most frequently used as an end joint for the top-rail of safety railing on a level site.

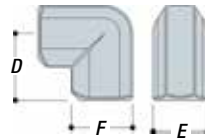

TYPE	Pipe ref.	in.			lb.
	A	D	E	F	
L15-6	6	2.05	1.67	2.20	0.31
L15-7	7	2.56	2.09	2.32	0.62
L15-8	8	2.91	2.36	2.56	0.88
L15-9	9	3.54	2.91	3.07	1.46

L19

Adjustable Side Outlet Tee (60°–200°)

Used to form variable angle joints between 60° and 200°. Not designed to absorb bending loads at barrier intersection.

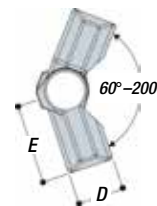
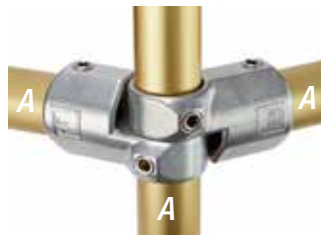

TYPE	Pipe ref.	in.		lb.
	A	D	E	
L19-6	6	1.67	2.95	0.79
L19-7	7	2.09	3.54	1.28
L19-8	8	2.36	3.54	1.46

Note: Type L19 components are bagged in pairs and are weighed, priced, and sold as such. Weight below refers to pairs.

L20

Side Outlet Elbow (90°)

A 90° corner joint most frequently used for the top-rail of safety railing. It can also be used for the corner joint of benches, work tables and other rectangular structures.

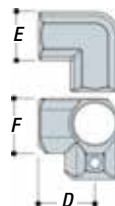
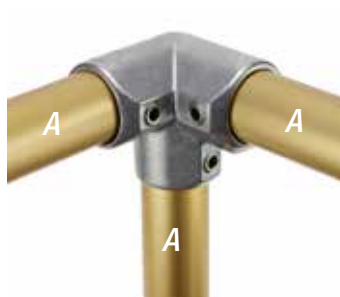

TYPE	Pipe ref.	in.			lb.
	A	D	E	F	
L20-6	6	2.05	1.67	1.97	0.42
L20-7	7	2.56	2.09	2.32	0.77
L20-8	8	2.91	2.36	2.56	1.10

Keel Klamp steel version available

L21

Side Outlet Tee (90°)

Most frequently paired with type L20 to give a 90° corner joint for the middle rail of safety railing and other rectangular structures. The upright passes through the component.

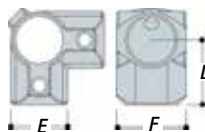
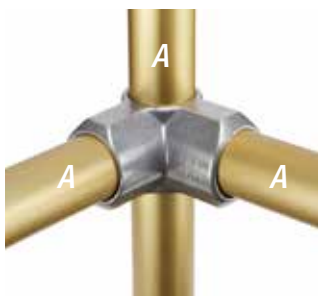

TYPE	Pipe ref. A	in.			lb.
		D	E	F	
L21-6	6	2.05	1.67	2.20	0.35
L21-7	7	2.56	2.09	2.52	0.66
L21-8	8	2.91	2.36	2.76	0.95

L25

Three Socket Tee

Commonly used as the 90° joint between the top-rail and an intermediate upright on safety railing. As there are two socket set screws in the sleeve, this component can be used where a join is required in the horizontal pipe. The Type L10 component can be used as an alternative when a join in the pipe is not required.

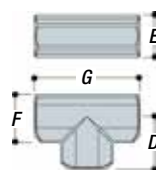
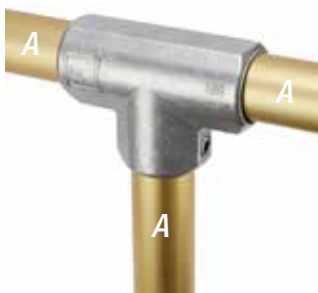

TYPE	Pipe ref. A	in.				lb.
		D	E	F	G	
L25-6	6	2.05	1.67	1.97	4.09	0.46
L25-7	7	2.56	2.09	2.32	5.12	0.77
L25-8	8	2.91	2.36	2.56	5.83	1.12
L25-9	9	3.54	2.91	3.07	7.09	1.81

L26

Two Socket Cross

Usually paired with Type L25 to give a 90° joint between the middle rail and an intermediate upright on safety railing. The upright passes through the component.

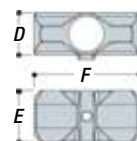
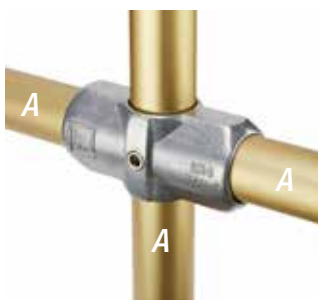

TYPE	Pipe ref. A	in.			lb.
		D	E	F	
L26-6	6	1.67	2.20	4.09	0.37
L26-7	7	2.09	2.52	5.12	0.62
L26-8	8	2.36	2.76	5.83	0.99
L26-9	9	2.91	3.23	7.09	1.46

L29

Single Socket Tee (30°–60°)

This adjustable component is most frequently used for struts and braces. It can be used at any selected angle between 30° and 60°. Suitable for connecting an angled staircase rail to a vertical upright.

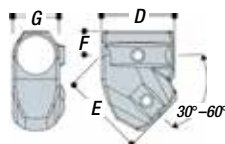

TYPE	Pipe ref. A	in.				lb.
		D	E	F	G	
L29-7	7	3.23	3.74	1.06	2.07	0.70
L29-8	8	3.66	4.25	1.18	2.32	0.90

L30

Adjustable Cross (30°–45°)

This adjustable component can be used for railing on staircases between the mid-rail and intermediate upright which is required to remain vertical. It can be used at any selected angle between 30° and 45°.

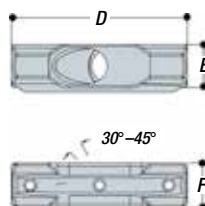
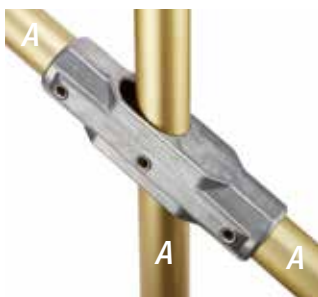

TYPE	Pipe ref. A	in.			lb.
		D	E	F	
L30-7	7	8.46	2.07	2.13	1.15
L30-8	8	9.65	2.34	2.36	1.52

L35

Three Socket Cross

Most frequently used to tie uprights with horizontal pipe in three directions, all 90° to the upright. The upright passes through the component.

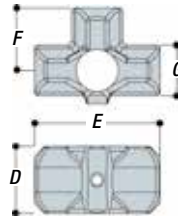
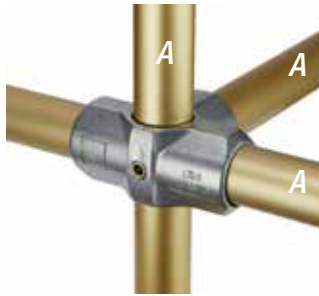

TYPE	Pipe ref.		in.				lb.
	A	D	E	F	G		
L35-6	6	2.20	4.09	2.05	1.67	0.68	
L35-7	7	2.52	5.12	2.56	2.09	0.90	
L35-8	8	2.75	5.82	2.91	2.36	1.19	

L40

Four Socket Cross

Most frequently used in multiple upright structures to tie a centre upright with horizontal pipes in four directions. The upright passes through the component.

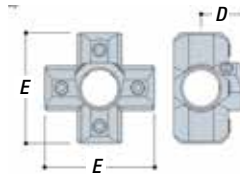
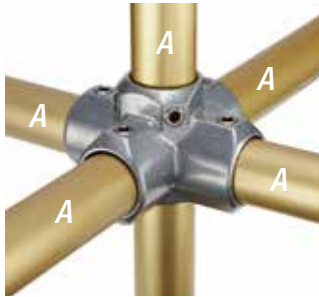

TYPE	Pipe ref.		in.		lb.
	A	D	E		
L40-7	7	5.12	1.97		1.14
L40-8	8	5.82	2.23		1.32

L45

Crossover

Designed to give a 90° offset crossover joint. Frequently used on safety railing utilising a continuous horizontal rail, minimising pipe cuts to reduce costs. Type L45 may also be used to allow intermediate levels on racks.

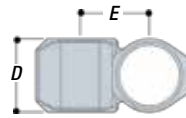
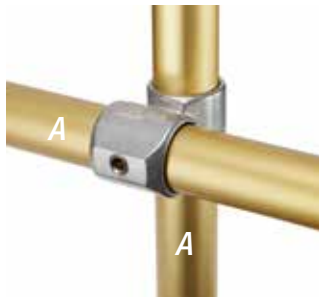

TYPE	Pipe ref.		in.		lb.
	A	D	E		
L45-6	6	1.73	1.57		0.26
L45-7	7	2.13	1.97		0.68
L45-8	8	2.40	2.20		0.77

L46

Combination Socket Tee and Crossover

Used on racking to join horizontal carrying rails to the upright, leaving the socket to take a horizontal pipe outside the upright. On pallet racking, it is preferable to have the carrying rails inside the upright.

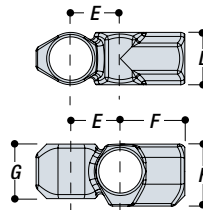
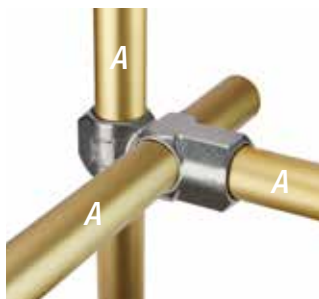

TYPE	Pipe ref.		in.					lb.
	A	D	E	F	G	H		
L46-6	6	1.67	1.57	2.05	1.73	1.97	0.42	

LC50

Single Swivel Socket

A complete combination swivel component, variable through 170°

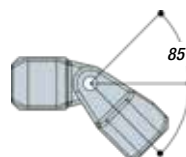
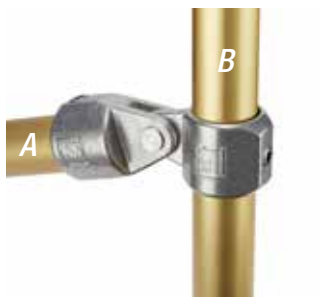

TYPE	Pipe ref.		lb.
	A	B	
LC50-66	6	6	0.68
LC50-77	7	7	0.90
LC50-88	8	8	1.10

WARNING: Swivel components are not designed to resist bending loads. A structure should not be designed entirely of swivel components as they will not provide sufficient stability for the structure.

Keel Klamp steel version available

LF50

Female Single Swivel Socket Member

The female part of a swivel component combination.

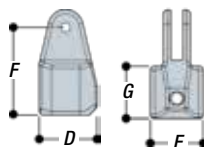

TYPE	Pipe ref.	in.					lb.
	A	D	E	F	G		
LF50-6	6	1.97	1.67	2.95	0.38	0.37	
LF50-7	7	2.32	2.09	3.54	0.38	0.55	
LF50-8	8	2.56	2.36	3.54	0.38	0.64	

LM50

Male Single Swivel Socket Tee

The male portion of a swivel component combination. The component can also be used to attach flat panels to tubular structures.

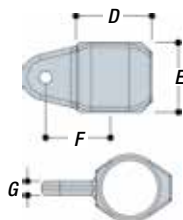

TYPE	Pipe ref.	in.						lb.
	A	D	E	F	G	Ø		
LM50-6	6	1.97	1.73	1.85	0.43	0.38	0.26	
LM50-7	7	2.32	2.00	1.97	0.43	0.38	1.33	
LM50-8	8	2.56	2.36	2.17	0.43	0.38	1.44	

Ø indicates the diameter of the fixing hole.

LC51

Double Swivel Socket

Complete combination component. Reducing combinations of Type LC51 are available in sizes 6, 7 and 8.

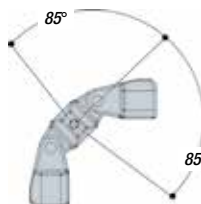
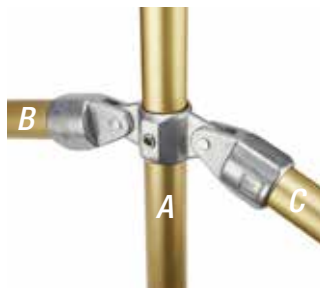

TYPE	Pipe ref.			lb.
	A	B	C	
LC51-666	6	6	6	1.26
LC51-777	7	7	7	1.61
LC51-888	8	8	8	1.88

LM51

Male Double Swivel Socket Member

One half of a combination component. This component can also be used for attaching flat panels to tubular structures.

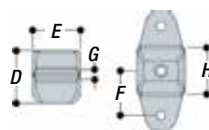

TYPE	Pipe ref.	in.							lb.
	A	D	E	F	G	H	Ø		
LM51-6	6	1.97	1.73	1.85	0.43	1.67	0.38	0.35	
LM51-7	7	2.32	2.00	1.97	0.43	2.09	0.38	0.51	
LM51-8	8	2.56	2.36	2.17	0.43	2.36	0.38	0.60	

Ø indicates the diameter of the fixing hole.

LC52

Corner Swivel Socket

Complete combination component. Reducing combinations of type LC52 are available in sizes 6, 7 and 8. See Type LM52 and Type LF50 for measurements.

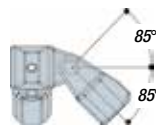
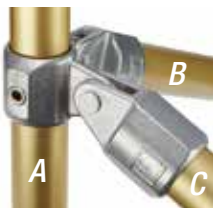

TYPE	Pipe ref.			lb.
	A	B	C	
LC52-666	6	6	6	1.06
LC52-777	7	7	7	1.48
LC52-888	8	8	8	1.76

Note: Swivel components are not designed to resist bending loads. A structure should not be designed entirely of swivel components as they will not provide sufficient stability for the structure.

LM52

Male Corner Swivel Socket Member

One half of a combination component. This component can also be used for attaching flat panels to tubular structures.

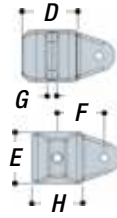

TYPE	Pipe ref.	in.						lb.
		A	D	E	F	G	H	
LM52-6	6	1.97	1.73	1.85	0.43	1.67	0.38	0.35
LM52-7	7	2.32	2.00	1.97	0.43	2.09	0.38	0.51
LM52-8	8	2.56	2.36	2.17	0.43	2.36	0.38	0.60

Ø indicates the diameter of the fixing hole.

LB54

Adjustable Elbow (45°–200°)

A swivel component designed as an in-line variable angle connection, adjustable from 45° to 200°.

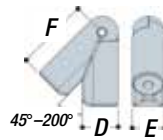

TYPE	Pipe ref.	in.			lb.
		A	D	F	
LB54-66	6	1.97	1.67	3.94	0.77
LB54-77	7	2.28	2.17	4.69	1.43
LB54-88	8	2.56	2.36	5.16	1.61

L55

Obtuse Angle Elbow

The Type L55 is an ideal component to use as an alternative to bending, or when a junction between a sloping pipe and an end post (i.e. guardrail and staircases).

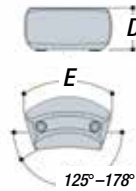

TYPE	Pipe ref.	in.		lb.
		D	E	
L55-6	6	1.97	4.49	0.37
L55-7	7	2.28	5.98	0.73
L55-8	8	2.52	5.90	0.79

L55A

Variable Elbow (11°–30°)

The Type L55A is an ideal component to use as an alternative to bending or when a junction between a sloping pipe and an end post.

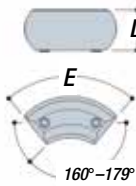

TYPE	Pipe ref.	in.		lb.
		D	E	
L55A-7	7	2.32	6.49	0.64
L55A-8	8	2.52	6.49	0.86

L56

Acute Angle Elbow (30°–45°)

Type L56 is an ideal component to use as an alternative to bending, or when a junction between a sloping pipe (30°–45°) and an end post (i.e. guardrail and staircases).

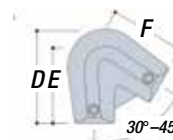

TYPE	Pipe ref.	in.			lb.
		A	D	F	
L56-7	7	4.72	3.90	4.72	1.03
L56-8	8	5.39	4.41	5.39	1.36

Keel Klamp steel version available

L56A

Acute Angle Elbow (11°–30°)

Type L56A is an ideal component to use as an alternative to bending, or when a junction between a sloping pipe (11°–30°) and an end post (i.e. guardrail on staircases) between.

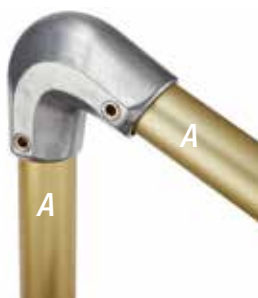

TYPE	Pipe ref.	in.			lb
	A	D	E		
L56A-7	7	4.25	4.25	0.95	
L56A-8	8	4.49	4.49	1.08	

LC58

Swivel Flange

A swivel component for attachment of angled pipe to a flat surface. See Type LM58 and Type LF50 for measurements.



TYPE	Pipe ref.	in.	lb.
	A	Ø	
LC58-6	6	0.45	0.74
LC58-7	7	0.45	1.93
LC58-8	8	0.45	1.46

Ø indicates the diameter of the fixing hole.

WARNING: This component is not recommended for use as a base flange to support guardrail or balustrades.

LM58

Double Swivel Socket

The male part of a swivel component for attaching angled piping to flat surfaces.

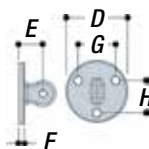

TYPE	in.					Rivet hole dia.	Fixing hole dia.	lb.
	D	E	F	G	H	Ø	Ø	
LM58	3.83	1.32	0.31	2.07	1.78	0.38	0.45	0.37

Ø indicates the diameter of the fixing hole.

L61

Flange

This flange, with holes provided for countersunk head fixing screws only, is used in structures where the fixing required is positional only. Frequently used as a wall fixing bracket.

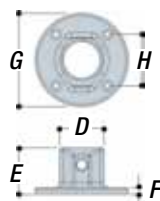

TYPE	Pipe ref.	in.						lb.
	A	D	E	F	G	H	Ø	
L61-6	6	1.67	1.97	0.31	3.94	1.93	0.25	0.46
L61-7	7	2.09	2.17	0.31	4.33	2.40	0.25	0.64
L61-8	8	2.36	2.36	0.31	4.72	2.64	0.25	0.71

Ø indicates the diameter of the fixing hole.

WARNING: It is not recommended for use as a base flange to support guardrail or balustrades (see Type 62).

L62

Standard Railing Flange

Should always be used to fix guardrail. Holes are designed for both mechanical and chemical anchors. Two set screws in the vertical socket give greater stability to the upright. It is recommended that the fixing holes in the flange be in-line with the applied load.

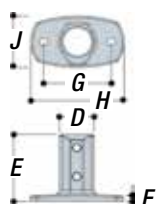

Note: The pipe is able to pass through the base of the component.

TYPE	Pipe ref.	in.							lb.
	A	D	E	F	G	H	J	Ø	
L62-6	6	1.97	3.54	0.35	3.50	5.04	2.95	0.55	0.77
L62-7	7	2.18	3.54	0.35	4.02	5.51	3.23	0.55	0.94
L62-8	8	2.43	3.54	0.35	4.53	6.30	3.31	0.55	0.71

Ø indicates the diameter of the fixing hole.

L63

Angle Base Flange (45°-60°)

Similar to a Type L62, but used to set up the upright at an angle between 45° to 60°. This component should only be subjected to light loads which cannot be positioned at 90° to the applied loads. For greater loads or other pipe sizes, a Type L62 flange is used and the upright bent to the required angle.

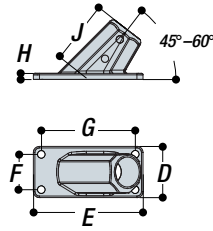

TYPE	Pipe ref.	in.							lb.
	A	D	E	F	G	H	J	Ø	
L63-8	8	3.31	7.08	2.28	6.06	0.39	3.58	0.47	1.52

L67

Angle Flange

Type L67 has been designed to allow the upright to pivot in the barrel, providing an angular displacement from 87° up to a maximum of 79°, measured from the vertical. Ideal to secure balustrade and guardrail systems on access ramps or other types of slopes.

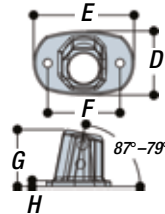
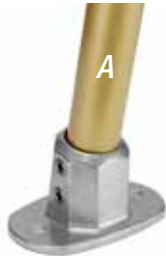

TYPE	Pipe ref.	in.						lb.
	A	D	E	F	G	H	Ø	
L67-8	8	4.01	6.30	4.53	3.54	0.35	0.55	1.28

L68

Wall Flange

Side palm flange for fixing guardrail and balustrades to walls, parapets, steps and ramps. The upright cannot drop through the socket. Note: If the upright is required to pass through the component by machining out the base stop, the bottom fixing hole becomes unusable.

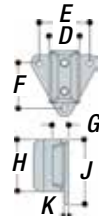

TYPE	Pipe ref.	in.								lb.
	A	D	E	F	G	H	J	K	Ø	
L68-6	6	1.67	2.80	2.52	0.95	2.95	3.98	0.31	0.45	0.53
L68-7	7	2.09	3.36	3.15	1.10	3.50	4.45	0.31	0.45	0.77
L68-8	8	2.36	3.78	3.62	1.22	3.94	5.04	0.31	0.45	0.95

L69

Railing Flange with Toeboard Adaptor

The railing flange has been designed for guardrail and balustrades and allows attachment of a toeboard to the base. The base plate can use a mechanical or chemical anchor; the side plates have slotted holes to allow for a degree of sideways movement for ease of installation.*

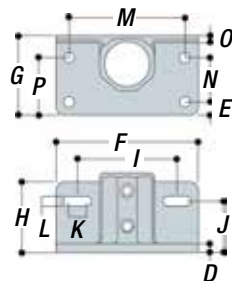

TYPE	Pipe ref.	in.										lb.
	A	D	E	F	G	H	I	J	Ø			
L69-7	7	0.39	0.59	5.71	3.15	3.15	3.78	2.28			1.41	
		K	L	M	N	O	P	Ø				
		0.79	0.45	4.53	1.57	0.31	2.16	0.45				
L69-8	8	0.39	0.59	6.30	3.54	3.15	4.41	2.28			1.65	
		K	L	M	N	O	P	Ø				
		0.79	0.45	5.12	1.97	0.31	2.24	0.45				

Ø indicates the diameter of the fixing hole.

*A toeboard designed for use with Type L69 railing flange is available from Kee Safety. (See page 55.)

L70

Rail Support

This component, with holes provided for countersunk head screw fixings only, is designed to carry handrails along walls or to fix structures back to walls. The pipe passes through the component and cannot be joined within the component. Type 70 is also used to attach toeboards to the base of guardrail uprights.

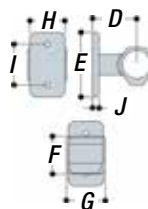

TYPE	Pipe ref.	in.								lb.
	A	D	E	F	G	H	I	J	Ø	
L70-6	6	2.36	3.62	1.97	1.97	1.77	2.68	0.39	0.31	0.44
L70-7	7	2.68	4.13	2.32	2.36	2.13	3.19	0.39	0.31	0.75
L70-8	8	2.95	4.53	2.56	2.60	2.36	3.58	0.39	0.31	0.99

Ø indicates the diameter of the fixing hole.

WARNING: Type 70 components are not designed to be used as base flanges for full height guardrails or handrails.

Keel Klamp steel version available

L84

Metal Plug

A metal drive-in plug. For proper insertion, a rubber mallet should be used. The metal plug is difficult to remove once installed.

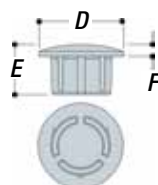

TYPE	Pipe ref.	in.				lb.
	A	D	E	F		
L84-6	6	1.34	1.20	0.22	0.04	
L84-7	7	1.69	1.22	0.24	0.11	
L84-8	8	1.93	1.22	0.24	0.11	

L114

Swivel Tee

An internal swivel component designed to accommodate varying angles on handrail, staircases, ramps or bracing. Used in conjunction with types L10, L15, L25 or L45, it eliminates the need for specialty drilled angle components.

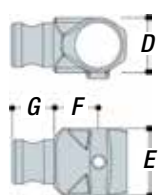

TYPE	Pipe ref.	in.					lb.
	A	D	E	F	G		
L114-6	6	1.97	2.20	1.77	1.26	0.40	
L114-7	7	2.09	2.52	1.69	1.57	0.64	
L114-8	8	2.36	2.76	1.81	1.57	0.78	

Ø indicates the diameter of the fixing hole.

WARNING: This component is not recommended for use as a base flange to support guardrail or balustrades.

L148

Heavy Duty Rectangular Flange

This a structural base fixing is used to fix down guardrail and balustrades. Available with either two or four fixing holes. The two socket set screws give greater stability to the upright. It is recommended that fixing holes be in-line with the applied load.

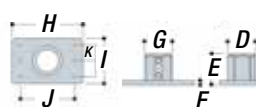

Note: The L148-92 has two holes; the L148-94 has four holes.

TYPE	Pipe ref.	in.						lb.
	A	D	E	F	G	H		
L148-92	9	1.97	3.54	0.35	3.50	5.04	0.77	
		I	J	K	Ø			
		-	-	2.95	0.55			
L148-94	9	2.18	3.54	0.35	4.02	5.51	0.94	
		I	J	K	Ø			
		-	-	3.23	0.55			

Ø indicates the diameter of the fixing hole.

L150

Heavy Duty Four Hole Square Flange

A heavy duty, four point fixing flange. Ideal when a structural fixing is required.

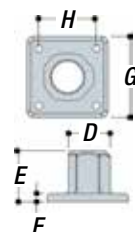

TYPE	Pipe ref.	in.						lb.
	A	D	E	F	G	H	Ø	
L150-8	8	2.56	3.00	0.51	5.00	3.50	0.45	1.61

Ø indicates the diameter of the fixing hole.

L152

Four Hole Square Flange

A four point fixing flange.

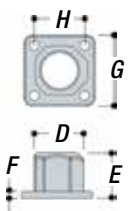

TYPE	Pipe ref.	in.						lb.
	A	D	E	F	G	H	Ø	
L152-6	6	1.97	1.81	0.25	2.99	2.06	0.31	0.35
L152-7	7	2.32	2.17	0.31	3.35	2.38	0.45	0.59
L152-8	8	2.56	2.56	0.31	3.62	2.63	0.45	0.68

Ø indicates the diameter of the fixing hole.

L160

Smooth Handrail Fitting

Designed to provide attachment for a smooth handrail. The component swivels during installation, allowing the handrail to be placed at any angle. The component is supplied as a kit including fasteners.

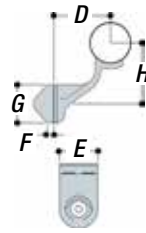
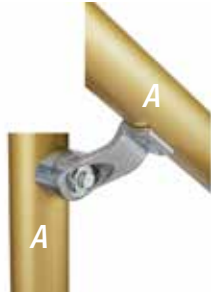

TYPE	Pipe ref.	in.					lb.
	A	D	E	F	G	H	
L160-7	7	2.32	1.57	0.39	1.57	2.52	0.24
L160-8	8	2.32	1.57	0.31	1.57	2.64	0.22

L164

Offset Wall Flange

This component is designed for palm fixing of uprights to steel channels, walls, parapets, steps and ramps. The upright cannot drop through the socket.

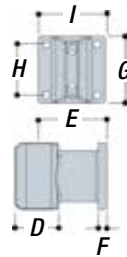

TYPE	Pipe ref.	in.					lb.	
	A	D	E	F	G	H		Ø
L164-8	8	2.56	4.00	0.50	4.00	3.00	0.45	1.87

Ø indicates the diameter of the fixing hole.

L262

Round Base Flange

Sleek round base flange. A single fixing hole is hidden to create a more aesthetic look. The two set screws in the vertical socket give greater upright stability.

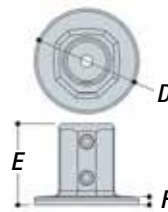

TYPE	Pipe ref.	in.			lb.
	A	D	E	F	
L262-7	7	3.94	3.54	0.35	0.92
L262-8	8	4.57	3.54	0.35	1.12

L320LH

Left hand level to Sloping Down Side Outlet Elbow (30°-45°)

Left Hand Side Outlet Elbow component designed for the top-rail on guardrail on slopes and staircases between 30° and 45° at the junction where the handrail changes from level to sloping down the stairs.

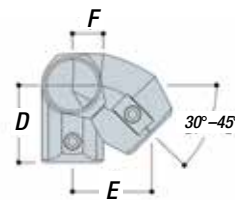

Note: handing perspective for Kee Lite is looking UP the staircase.

TYPE	Pipe ref.	in.			lb.
	A	D	E	F	
L320LH-7	7	2.64	2.56	1.06	0.86
L320LH-8	8	2.99	2.91	1.18	1.12

L320RH

Right hand level to Sloping Down Side Outlet Elbow (30°-45°)

Right Hand Side Outlet Elbow component designed for the top-rail on guardrail on slopes and staircases between 30° and 45° at the junction where the handrail changes from level to sloping down the stairs.

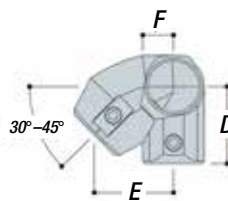

Note: handing perspective for Kee Lite is looking UP the staircase.

TYPE	Pipe ref.	in.			lb.
	A	D	E	F	
L320RH-7	7	2.64	2.56	1.06	0.86
L320RH-8	8	2.99	2.91	1.18	1.12

Keel Klamp steel version available

L321LH

Left hand level to Sloping Down Side Outlet Tee (30°-45°)

Left Hand Side Outlet Tee component designed for the mid-rail on guardrail on slopes and staircases between 30° and 45° at the junction where the handrail changes from level to sloping down the stairs.

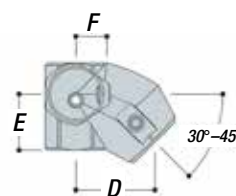
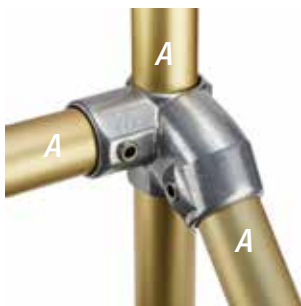

Note: handing perspective for Keel Lite is looking UP the staircase.

TYPE	Pipe ref.		in.			lb.
	A	D	E	F		
L321LH-7	7	2.64	1.97	1.06	0.79	
L321LH-8	8	2.99	2.13	1.18	0.95	

L321RH

Right hand level to Sloping Down Side Outlet Tee (30°-45°)

Right Hand Side Outlet Tee component designed for the mid-rail on guardrail on slopes and stair-cases between 30° and 45° at the junction where the handrail changes from level to sloping down the stairs.

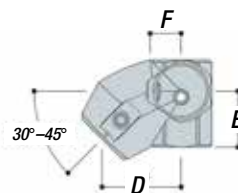
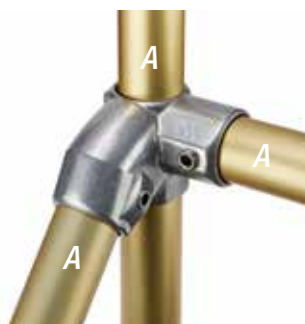

Note: handing perspective for Keel Lite is looking UP the staircase.

TYPE	Pipe ref.		in.			lb.
	A	D	E	F		
L321RH-7	7	2.64	1.97	1.06	0.79	
L321RH-8	8	2.99	2.13	1.18	0.95	

L325

Level to Sloping Down Tee (30°-45°)

Tee component designed for the top-rail on guardrail on slopes and staircases between 30° and 45° at the junction where the handrail changes from level to sloping down the stairs.

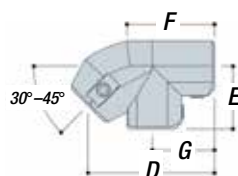
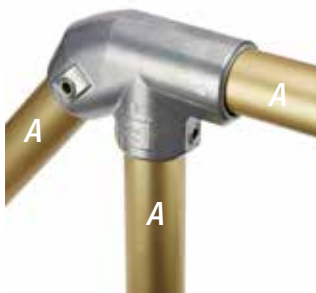

TYPE	Pipe ref.		in.				lb.
	A	D	E	F	G		
L325-7	7	5.19	2.56	2.56	3.97	0.86	
L325-8	8	5.90	2.91	2.91	4.41	1.12	

L325A

Level to Sloping Up Tee (30°-45°)

Tee component designed for the top-rail on guardrail on slopes and staircases between 30° and 45° at the junction where the handrail changes from level to sloping up the stairs.

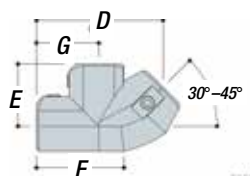
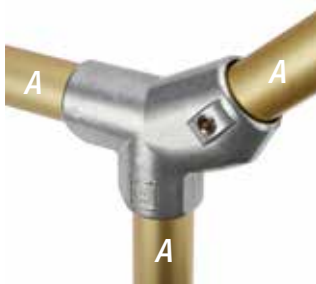

TYPE	Pipe ref.		in.				lb.
	A	D	E	F	G		
L325A-7	7	5.19	2.56	2.56	3.97	0.86	
L325A-8	8	5.90	2.91	2.91	4.41	1.12	

L326

Level to Sloping Down or Up Cross (30°-45°)

Level to Sloping Down or Up Cross (30°-45°) Cross component designed for the mid-rail on guardrail on slopes and staircases between 30° and 45° at the junction where the handrail changes from either level to sloping down or level to sloping up the stairs.

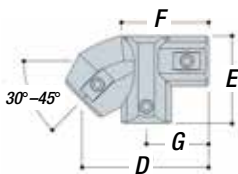
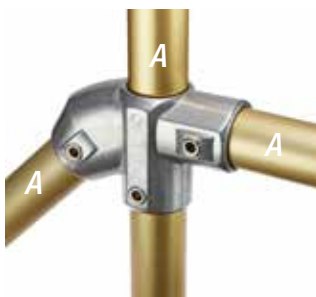

TYPE	Pipe ref.		in.				lb.
	A	D	E	F	G		
L326-7	7	5.19	3.62	3.62	2.56	0.88	
L326-8	8	5.90	4.09	4.09	2.91	1.14	

L427

Three Socket Tee (30°-45°)

This component is used on a safety railing with slopes between 30° and 45° and fixes the top-rail to a vertical intermediate upright.

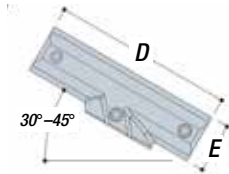
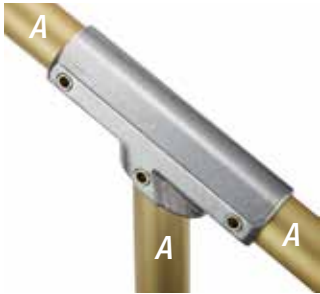

TYPE	Pipe ref.	in.		lb.
	A	D	E	
L427-7	7	7.08	2.05	0.99
L427-8	8	8.50	2.32	1.41

Gaskets

Neoprene Gaskets

Gaskets are available to prevent the corrosion associated with lime in concrete. The gaskets have more resistance than natural rubber to sunlight, ozone and oxidation. Neoprene is heat resistant and does not soften as natural rubber does under severe exposure. Gasket part numbers correspond to Kee Lite flange and base components as per table.



LG61-8	LG61-8	LG62-8	LG68-8	LG70-6	LG148-9	LG152-7
LG62-6	LG62-6	LG68-6	LG69-7	LG70-7	LG150-8	LG152-8
LG62-7	LG62-7	LG68-7	LG69-8	LG70-8	LG152-6	LG164-8



97

Set Screws

Socket set screws are supplied and inserted in all Kee Safety components as standard, the case hardened set screws that are fitted to Kee Klamp components are coated with Kee Koat. Kee Koat ensures at least four times the corrosion resistance of bright zinc plated alternatives. Kee Lite components are all supplied and fitted with grade 1.4301 stainless steel set screws.



TYPE	To suit pipe sizes	Size	Finish
97-4	4	1/8" BSF	BZP
97-6	5 6	ISO 228 1/4"	KEE KOAT
97-7	7 8 9	ISO 228 3/8"	KEE KOAT
97-6S	5 6	ISO 228 1/4"	Grade 1.4301 Stainless Steel
97-7S	7 8 9	ISO 228 3/8"	Grade 1.4301 Stainless Steel

97ATD

Anti-theft Device

Aluminum drive rivets discourages the tampering of set screws whilst creating a nice finished appearance. Drive rivets are easy to install. The rivet pin is hit with a hammer driving it flush with the rivet head and expanding the rear of the rivet. No special tools are necessary. One size fits components 5-9.



98

Ratchet Set

Reversible ratchet for easier fastening of grub screws (1/2" Drive, 10" long). Ratchet handle and hexagon bits are supplied separately. A/F refers to the dimensions across the flats.



Note: Actual product may differ from that shown. Image is for illustration purposes only.

TYPE	To suit pipe sizes	Sizes
98		Ratchet Handle (1/2" drive, 8" long)
98-4.9	5 6 7 8 9	Hexagon Bit (1/4" AF) (5/16" AF)

99

Hex Key

Simple hex key. A/F refers to the dimension across the flats.



TYPE	To suit pipe sizes	A/F
99-4	4	3/16"
99-6	5 6	1/4"
99-789	7 8 9	5/16"

100

Plastic Set Screw Cap

Grey plastic set screw caps provide the perfect finishing touch to Galvanized Kee Klamp components. Secure push-in-fit application.

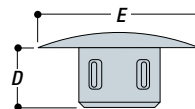

TYPE	To suit pipe sizes	in.		
		D	E	
100-56	5 6	0.24	0.63	To fit 97-5 and 97-6 set screws
100-789	7 8 9	0.24	0.63	To fit 97-7, 97-8 and 97-9 set screws

I-FP

In-fill Panels

Panels in a variety of materials, sizes and finishes. The standard 2" x 2" weld mesh is available in either Galvanized or powder coated finish. Maximum panel size is 94.5" x 47". Smaller opening are also available (1" x 1" or 2" x 2").



05 52 00 Metal Railings

PART 1-1 GENERAL

- 1.1 SCOPE
- 1.2 RELATED WORK
- 1.3 RAILING STRUCTURAL REQUIREMENTS
- 1.4 SUBMITTALS
- 1.5 QUALITY ASSURANCE

PART 2-2 PRODUCTS

2.1 SUPPLIER

- A. Manufacturer of handrail, guardrail or railing systems shall be the following except where otherwise noted on the Drawings:
 - Kee Safety, Inc.
 - 100 Stradtman Street
 - Buffalo, NY 14206
 - Tel: (716) 896-4949

2.2 SYSTEMS

- A. Handrails and Guardrails: Provide pipe, Kee Klamp, Kee Lite or Kee Access fittings and accessories as indicated or required to match the design indicated in the Drawings.

2.3 METALS

A. Pipe

- 1. Steel Pipe: ASTM A53.
- 2. Aluminum Pipe: ASTM B221.

B. Fittings and Castings

- 1. Cast Iron Fittings or Castings to comply with ASTM A47.
- 2. Hot Dip Galvanized finish to comply with BS EN 1562 & BS EN 1563.
- 3. Aluminum Alloy Fittings or Castings conforming to ASTM A 356-T6
- 4. Brackets, Flanges and Anchors: Cast or formed metal of same material and finish as supported rails.

2.4 OTHER MATERIALS

2.5 FABRICATION-GENERAL

PART 3-3 EXECUTION

- 3.1 EXAMINATION AND PREPARATION
- 3.2 INSTALLATION
- 3.3 JOB CLOSE OUT

A brief three part specification for Kee Safety components is shown above for quick reference. The full specification is available for download on the Kee Safety website.

Straight and Level Guard Rail

Using Types 10, 15, 20, 21, 25 and 26 or L10, L15, L20, L21, L25 and L26

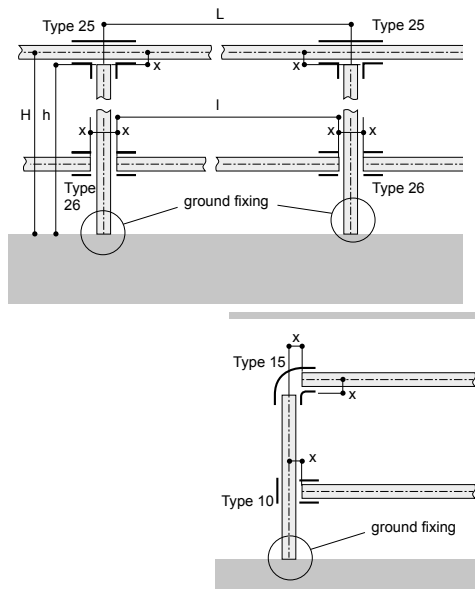

Where:

L = distance between centers of uprights

I = length of horizontal pipe

H = distance from ground to centre line of top-rail

h = length of upright pipe

Table 1

Dimension 'x' for fittings above, including Types 35, 40 and L35*

Fitting Size	x (in.)
3	-0.5
4	-0.5
5	-0.5
6	-0.625
7	-0.875
8	-1
9	-1.125

Table 1 gives details of dimension 'x' in the formula: $I = L - 2x$

To calculate rail lengths and uprights use the formula: $h = H - x \pm (\text{ground fixing})^*$

Note: When reducing fittings are being used care must be taken to use the correct 'x' dimension. (i.e., Type 10-87, vertical pipe size 8, horizontal pipe size 7. To find the correct length of the horizontal pipe, the length 'x' is that for the size 8 vertical pipe.) When using Types 35 and 40 the above 'x' dimension should be used. Although guardrailing is normally constructed in size 6, 7 and 8 pipe, Table 1 shows the cutting length for all Kee Klamp pipe sizes, and can therefore be applied to many other rectangular structures.

*When using Kee Lite bases, L61, L62, L69, L140, L150 and L152, "ground fixing" dimension will be zero.

Guardrailing up Slopes 0°–11°

Using Types 86, 87, 88 and 89

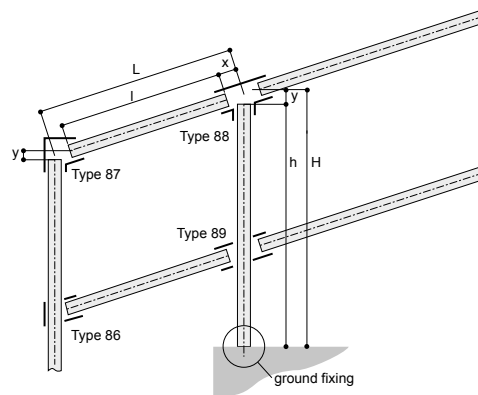

Where the upright remains vertical, i.e. ramps and stairways, (i) dimension 'x' to be subtracted from the upright centre dimension measured on the slope to give rail length. ($I = L - 2x$); (ii) dimension 'y' to be added to the centre dimension to give the length of the upright ($H = h + y + \text{ground fixing}$).

Table 2

Rails

Angle of Slope	Size 8 Fittings 'x' (in.)
0° to 4°	-1
5° to 9°	-1.125
10° to 11°	-1.25

Table 2 gives details of dimensions required for calculating the rail lengths, where angles are between 0° and 11°.

Table 3

Uprights

Angle of Slope	Size 8 Fittings 'y' (in.)
0° to 4°	-1
5° to 9°	-1.125
10° to 11°	-1.25

Table 3 gives details of dimensions required for calculating the upright lengths, where angles are between 0° and 11°.

Guardrail Up Slopes 11° to 30°

Using Types 55A, 56A, 327, 328 and 329 size 7 and 8

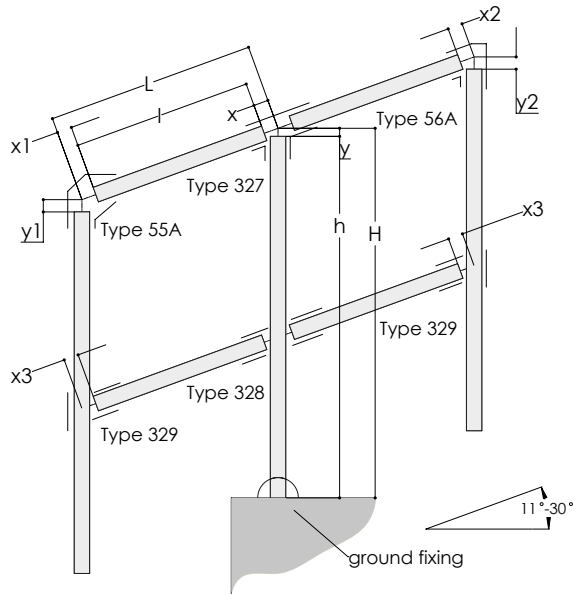

Where the upright remains vertical, i.e. stairways
 (i) dimension x, x1, x2, x3 to be subtracted from the upright centers; dimension (L) to give the rail length;
 (ii) dimension y, y1 and y2 for determining the upright length.

Guardrail up Slopes 30° to 45°

Using Types 29, 30, 55, 56 and 427 in sizes 7 and 8

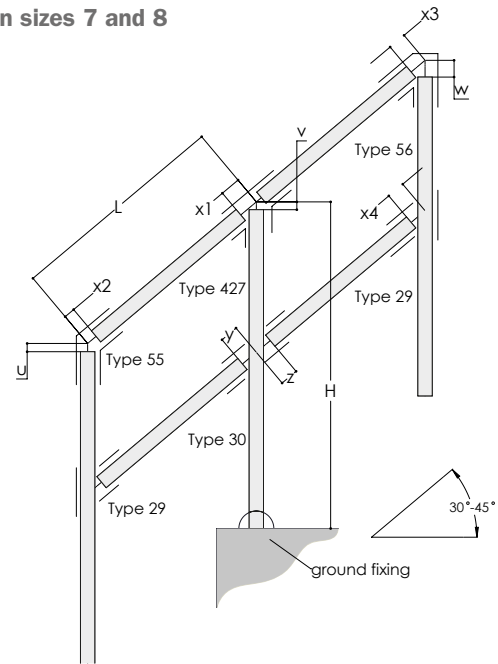

Where the upright remains vertical, i.e. stairways
 (i) dimension x, x1, x3, y & z to be subtracted from the upright centers; dimension (L) to give the rail length; (ii) dimension u, v and w for determining the upright length.

Table 1

Rails

Angle Of Slope	Fitting Size							
	7				8			
	x	x1	x2	x3	x	x1	x2	x3
11°	-1.02	-0.98	-1.38	-2.05	-1.14	-0.63	-1.38	-2.01
15°	-1.1	-0.83	-1.81	-2.09	-1.22	-1.06	-1.85	-2.05
20°	-1.18	-0.63	-1.89	-2.17	-1.34	-0.83	-1.93	-2.13
25°	-1.3	-0.59	-2.05	-2.32	-1.5	-0.87	-2.09	-2.24
30°	-1.46	-0.31	-2.24	-2.52	-1.65	-0.59	-2.32	-2.44

Table 1 gives details of dimensions required for calculating the rail lengths, where angle are between 11° & 30°.

Table 3

Rails

Angle Of Slope	Fitting Size											
	7						8					
	x1	x2	x3	x4	y	z	x1	x2	x3	x4	y	z
30°	-1.54	-0.79	-2.17	-1.46	-1.93	-2.17	-1.77	-0.87	-1.93	-1.69	-2.36	-2.91
35°	-1.73	-0.63	-2.4	-1.57	-1.97	-2.13	-1.97	-0.71	-2.17	-1.85	-2.36	-2.91
40°	-1.85	-0.79	-2.8	-1.77	-2.01	-2.09	-2.17	-0.83	-2.6	-2.05	-2.4	-2.91
45°	-1.97	-1.02	-3.35	-2.01	-3.58	-2.09	-2.17	-1.02	-3.19	-2.32	-2.68	-2.6

Table 3 gives details of dimensions required for calculating the rail lengths, where angle are between 30° & 45°.

Table 2

Uprights

Angle Of Slope	Fitting Size					
	7			8		
	y	y1	y2	y	y1	y2
11°	+0.28	-0.39	-1.1	+0.24	-0.28	-1.3
15°	+0.28	-0.43	-0.98	+0.24	-0.31	-1.18
20°	+0.28	-0.51	-1.34	+0.24	-0.39	-1.5
25°	+0.28	-0.59	-1.69	+0.24	-0.39	-1.89
30°	+0.28	-0.71	-2.09	+0.24	-0.55	-2.32

Table 2 gives details of dimensions required for calculating the upright lengths.

Table 4

Uprights

Angle Of Slope	Fitting Size					
	7			8		
	u	v	w	u	v	w
30°	-0.67	+0.2	-1.89	-0.98	+0.24	-1.93
35°	-0.63	+0.2	-2.32	-0.83	+0.24	-2.32
40°	-0.31	+0.12	-2.72	-0.55	+0.24	-2.72
45°	+0.08	-0.04	-3.15	-0.08	-0.16	-3.19

Table 4 gives details of dimensions required for calculating the upright lengths.

Guardrail up slopes 30° to 45°

Using 325, 325A, 326, size 7 and 8

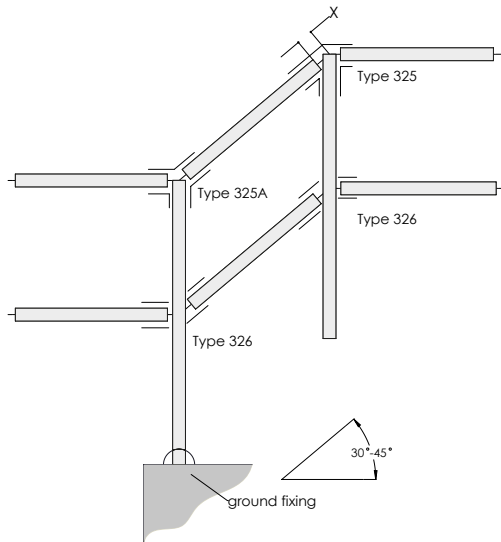

Table 5

Rails

Angle Of Slope	Fitting Size	
	7 x	8 x
30°	-1.85	-2.24
35°	-2.05	-2.44
40°	-2.32	-2.72
45°	-2.68	-3.11

Table 5 gives details of dimensions required for calculating the rail lengths, where angle are between 30° & 45°.

Guardrail up slopes 30° to 45°

Using 320RH, 320LH, 321RH and 321LH size 7 and 8

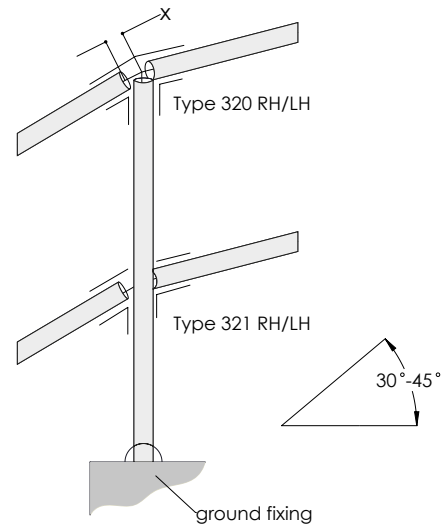

Table 6

Rails

Angle Of Slope	Fitting Size	
	7 x	8 x
30°	-2.17	-2.44
35°	-2.36	-2.68
40°	-2.64	-2.99
45°	-3.03	-3.39

Table 6 gives details of dimensions required for calculating the rail lengths, where angle are between 30° & 45°.

Slope Fittings

The latest addition to the Kee Klamp portfolio is an extension to the current range of slope fittings designed to enhance the building of guardrail along staircases and ramps particularly when the slope is greater than 30°. The range introduces single fittings to cater for situations where currently a combination of fittings is required. Not only does this improve the aesthetics of the finished guardrail but it also allows for a quicker and easier install. The range of slope fittings is available in Size 7 (outer diameter 1¼") and Size 8 (outer diameter 1½") designed for use with steel piping to ASTM A53.

Kee Klamp fittings are iron castings manufactured to the requirements of BS EN 1562 & BS EN 1563. They are supplied hot dip Galvanized to ASTM A123.

A Kee Klamp fitting can support an axial load of 2000 lbs. per set screw tightened to a torque of 29ft.lbs. In common with all Kee Klamp products, the threaded recesses of each fitting are covered with Threshcoat protective coating to provide enhanced corrosion resistance and all grub screws are manufactured in case hardened steel coated with Kee Coat for corrosion protection.

Features and Benefits

- Kee Klamp is the best known brand of slip-on pipe fittings available for over 80 years
- Manufactured to stringent quality standards to ensure consistent performance
- Extended range of slope fittings gives greater design flexibility
- Adjustability in the fittings allows greater on-site tolerances to be met
- Using single fittings rather than pairs speed up installation times

Guardrailing up Slopes 11°–30° Using Adjustable Fittings, Types 327 and 328

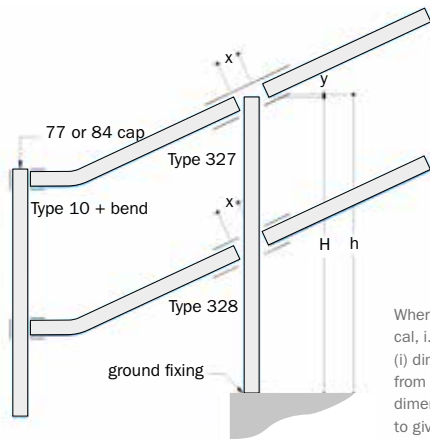

Where the upright remains vertical, i.e. ramps and stairways, (i) dimension 'x' to be subtracted from the upright centers dimension measured on the slope to give rail length. ($l = L - 2x$); (ii) dimension 'y' to be added to the centre dimension to give the length of the upright ($h = H + Y + \text{ground fixing}$).

Table 4

Rails

Angle of Slope	Size 7 Fittings: 'x' (in.)	Size 8 Fittings: 'x' (in.)
11°	-1.1	-1.18
15°	-1.26	-1.38
20°	-1.26	-1.5
25°	-1.38	-1.61
30°	-1.61	-1.73

Table 4 gives details of dimensions required for calculating the rail lengths, where angles are between 11° and 30°.

Table 5

Angle of Slope	Size 7 Fittings: 'y' (in.)	Size 8 Fittings: 'y' (in.)
11°	+0.63	+0.75
15°	+0.63	+0.75
20°	+0.51	+0.63
25°	+0.51	+0.63
30°	+0.51	+0.51

Table 5 gives details of dimensions required for calculating the upright lengths, where angles are between 11° and 30°.

Guardrailing up Slopes 30°–45° Using Adjustable Fittings, Types 29, 30, 55 and 56 or Types L29 and L30 size 6, 7 and 8

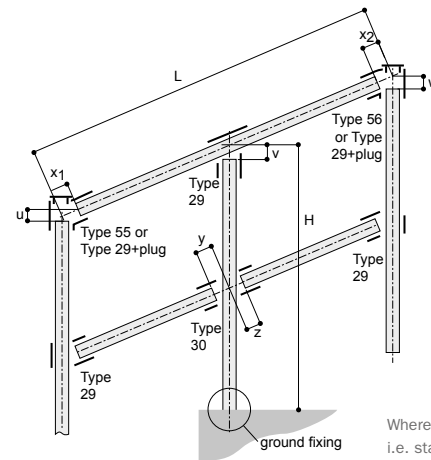

Where the upright remains vertical, i.e. stairways (i) dimension x, y, or z to be subtracted from the upright centers: dimension (L), to give the rail length; (ii) dimension u, v and w for determining the upright length.

Table 6

Rails

Angle of Slope	Size 6 Fitting			Size 7 Fitting			Size 8 Fitting		
	x (in.)	y (in.)	z (in.)	x (in.)	y (in.)	z (in.)	x (in.)	y (in.)	z (in.)
30°	-1.25	-2.125	-1.375	-1.625	-2.5	-1.625	-1.75	-3	-2.125
35°	-1.375	-2	-1.5	-1.75	-2.375	-1.75	-2	-2.875	-2.25
40°	-1.5	-1.875	-1.63	-1.875	-2.25	-1.875	-2.125	-2.5	-2.375
45°	-1.75	-1.75	-1.75	-2.125	-2	-2	-2.375	-2.5	-1.625

Table 6 gives details of dimensions required for calculating the rail lengths, where angles are between 30° and 45°.

Table 7

Uprights

Angle of Slope	Size 6 Fitting			Size 7 Fitting			Size 8 Fitting		
	u (in.)	v (in.)	w (in.)	u (in.)	v (in.)	w (in.)	u (in.)	v (in.)	w (in.)
30°	0.625	-1.25	+1	+0.25	-1.625	+1.125	+1.875	-1.75	+1.25
35°	0.375	-1.375	+0.75	+2	-1.75	+0.875	+2.125	-2	+1
40°	0.125	-1.5	+0.5	+1.625	-1.875	+0.5	+2.5	-2.125	+0.5
45°	1.75	-1.75	+0.125	+1.25	-2.125	+0.125	+3	-2.375	+0.125

Table 7 gives details of dimensions required for calculating the upright lengths, where angles are between 30° and 45°.

Table 8

Uprights and rails using Types 55 and 56 – Size 8 only

Angle	u (in.)	x ₁ (in.)	w (in.)	x ₂ (in.)
20° to 29°	-0.75	-0.75	-2	-2
30° to 39°	-0.625	-0.625	-2.375	-2.375
40° to 49°	-0.5	-0.5	-2.75	-2.75
50° to 59°	-0.5	-0.5	-	-
60° to 69°	-0.375	-0.375	-	-
70° to 79°	-0.375	-0.375	-	-
80° to 88°	-0.25	-0.25	-	-

Table 8 gives details of dimensions required for calculating the upright lengths.

Shelving

Using Type 46 or L46

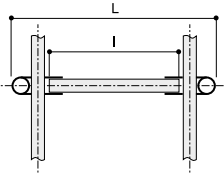

Table 9

Shelving with carrying rails positioned on the outside of the upright

Fitting Size	x (in.)
4	-3.875
5	-5.25
6	-6.375
7	-7.75
8	-9
9	-10.875

Table 9 gives the dimension 'x' to be subtracted from overall shelf width 'L' to give the length of the cross rail in the formula $l = L - x$. (Dimension x accounts for the use of two Type 46 or L46 fittings.)

Pallet Racking

Using Type 46 or L46

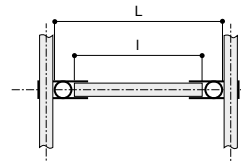

Table 11

Pallet racking with the carrying rails on the inside of the upright

Fitting Size	x (in.)
4*	-1.875
5*	-2.38
6*	-7.88
7	-3.38
8	-4
9	-5

Table 11 gives dimension 'x' which must be subtracted from the overall width of the carrying rails, to give the length of the cross rail in the formula: $l = L - x$. (Dimension x accounts for the use of two Type 46 or L46 fittings.)

*Pallet racking is not recommended in less than size 7 pipe.

Construction of Braces and Struts

Using Types C50, C51, C52 and C53 or LC50, LC51 and LC52

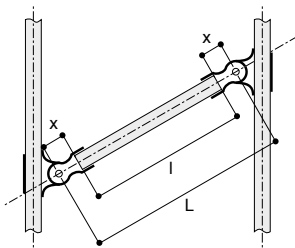

When using multiple pipe sizes in one structure, Types F50-5 to F50-9 or LF50-6 to LF50-8 can all be combined with:
 M50-5 to M50-9 LM50-6 to LM50-8
 M51-5 to M51-9 LM50-6 to LM50-8
 M52-5 to M52-8 LM52-6 to LM52-8
 M53-8
 to construct combination fittings (i.e. C50-75, C50-85, C51-655, C52-855 and C53-888).

Table 10

Shelving with carrying rails positioned on the outside of the upright.

Fitting Size	x (in.)
4	-0.5
5	-1
6	-1
7	-1
8	-1
9	-1.25

Table 10 gives details of dimension 'x' to be subtracted to give the pipe length required for use with two Type F50 or LF50 fittings in the formula $l = L - 2x$.

Note: Dimension 'L' is the length from pivot point to pivot point. The distance from upright to upright is dependent on the angle of the strut.

Table 12

Additional pipe length to reach topmost fitting's termination

Fitting Size	z (in.)
3	+1
4	+1.125
5	+1.25
6	+1.5
7	+1.875
8	+2
9	+2.38

The length of the longitudinal member can be calculated from multiples of the length of the bay between the centers of uprights, plus dimension 'z' in Table 12. Dimension z accounts for the length of pipe needed to go through the topmost fitting to the fitting's termination. This also applies to constructions using fitting Type 45.

Longitudinal pipes are joined using fittings Type 14 or 18 couplings (use of Type 18 is not recommended as a load bearing joint), which must be positioned to occur at the edge of the Type 46 fitting, and must not all occur in the same bay at alternate levels.

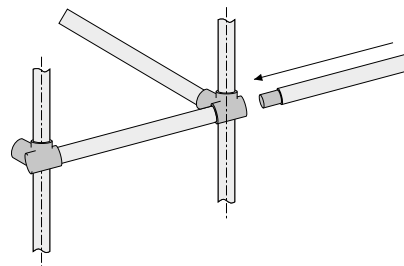

Spigots can be either pipes or rods, riveted into position, or the Type 18 fitting. When using the latter, a gap of 3/4" must be allowed for the set screw fixing.

Base and Wall Fixings*

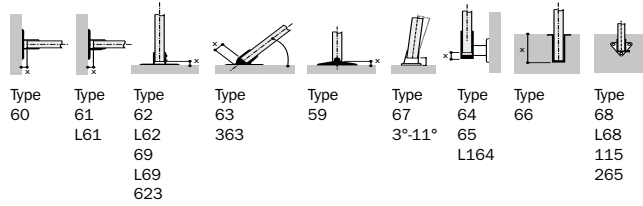

Table 13

Flange Type	x (in.)
59	-0.39
60	-0.39
61	-0.24
62	-0.24
67	-0.24
623	-0.47

Table 13 gives details of the ground fixing dimension 'x', to be subtracted from the height 'H' to give the length of the upright 'h'.

Table 14

Angle	x (in.)
45°	-1.5
50°	-1.25
60°	-1
65°	-0.5

Table 14 gives details of the ground fixing dimension 'x', for Type 63-6 only, to be subtracted to give the length of the upright for each angle condition.

Table 15

Angle	x (in.)
11°	-1.5
15°	-1.26
20°	-0.98
25°	-0.79
30°	-0.47

Table 15 gives details of the ground fixing dimension 'x' for Type 363, to be subtracted to give the length of the upright for each angle condition.

Table 16

Fitting Size	x (in.)
6	-0.25
7	-0.25
8	-0.25

Table 16 gives the dimension 'x' to be subtracted from the length of the upright for fitting Types 64, 65, 67, 68, 115, 265, L68 and L164.

Table 17

Fitting Size	x (in.)
6	+4.5
7	+5
8	+5

Table 17 gives the ground fixing dimension 'x', to be added to the upright member to allow for the setting into the socket Type 66.

*When using Kee Lite bases and flanges, "ground fixing" dimension (x) will be zero, except when using flanges L164, L68 and LC58.

Constructing Circles and Triangles

Worked Example

Slopes and radii present no problem to the Kee Klamp Galvanized railing systems. Fitting Types 27, 28, 29, 30, C50, C51, C52, 55, 56, 86, 87, 88 and 89 (and the 90 range pedestrian guardrail fittings) are designed to allow for raked handrail while keeping the uprights vertical. Pipe can be bent and radiused to suit most situations. Also, true lengths have to be determined where braces and struts are being used.

Consider the following concrete single flight staircase.

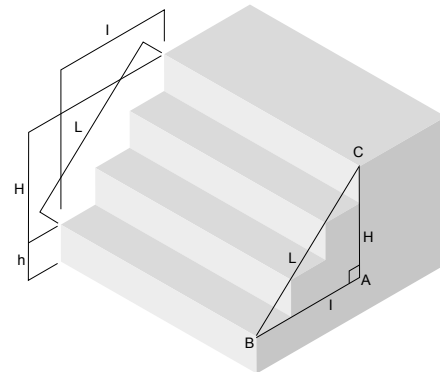

Where

H = Vertical height from 1st nosing to last nosing.

h = Vertical height from ground level to 1st nosing.

I = Horizontal dimension from 1st nosing to last nosing.

L = Hypotenuse dimension (Pitch Line) from 1st nosing to last nosing.

Known Data	Formula for Side and Angle		
H & L	$I = \sqrt{L^2 - H^2}$	$\sin B = \frac{H}{L}$	$C = 90^\circ - B$
L & I	$H = \sqrt{L^2 - I^2}$	$\sin C = \frac{I}{L}$	$B = 90^\circ - C$
H & I	$H = \sqrt{H^2 - I^2}$	$\tan B = \frac{H}{I}$	$C = 90^\circ - B$

Note: The table can be used to solve angles and true lengths for braces and struts.

Step 1

From a simple site survey or information from a working drawing, obtain the following dimensions.

Note: For greater accuracy, vertical dimensions should be taken by means of a Dumpy Level or a Theodolite.

H = vertical height from the 1st nosing to the last (140cm).

L = pitch line, the diagonal dimension from the 1st nosing to the last (240cm).

Step 2

From the table to determine angle B we use;

$\sin B = 55 / 96$, Angle B = 35°

Ramps can be dealt with in a similar way. Most ramps have a stated gradient (e.g. 1:1.2); for every 12 units traversed horizontally, 1 unit of vertical height is obtained.

Shelving

Using Type 46 or L46

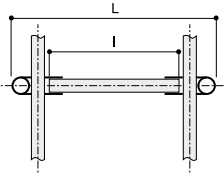

Table 9

Shelving with carrying rails positioned on the outside of the upright

Fitting Size	x (in.)
4	-3.875
5	-5.25
6	-6.375
7	-7.75
8	-9
9	-10.875

Table 9 gives the dimension 'x' to be subtracted from overall shelf width 'L' to give the length of the cross rail in the formula $l = L - x$. (Dimension x accounts for the use of two Type 46 or L46 fittings.)

Pallet Racking

Using Type 46 or L46

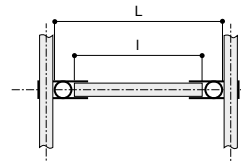

Table 11

Pallet racking with the carrying rails on the inside of the upright

Fitting Size	x (in.)
4*	-1.875
5*	-2.38
6*	-7.88
7	-3.38
8	-4
9	-5

Table 11 gives dimension 'x' which must be subtracted from the overall width of the carrying rails, to give the length of the cross rail in the formula: $l = L - x$. (Dimension x accounts for the use of two Type 46 or L46 fittings.)

*Pallet racking is not recommended in less than size 7 pipe.

Construction of Braces and Struts

Using Types C50, C51, C52 and C53 or LC50, LC51 and LC52

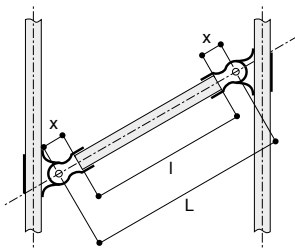

When using multiple pipe sizes in one structure, Types F50-5 to F50-9 or LF50-6 to LF50-8 can all be combined with:
 M50-5 to M50-9 LM50-6 to LM50-8
 M51-5 to M51-9 LM50-6 to LM50-8
 M52-5 to M52-8 LM52-6 to LM52-8
 M53-8
 to construct combination fittings (i.e. C50-75, C50-85, C51-655, C52-855 and C53-888).

Table 10

Shelving with carrying rails positioned on the outside of the upright.

Fitting Size	x (in.)
4	-0.5
5	-1
6	-1
7	-1
8	-1
9	-1.25

Table 10 gives details of dimension 'x' to be subtracted to give the pipe length required for use with two Type F50 or LF50 fittings in the formula $l = L - 2x$.

Note: Dimension 'L' is the length from pivot point to pivot point. The distance from upright to upright is dependent on the angle of the strut.

Table 12

Additional pipe length to reach topmost fitting's termination

Fitting Size	z (in.)
3	+1
4	+1.125
5	+1.25
6	+1.5
7	+1.875
8	+2
9	+2.38

The length of the longitudinal member can be calculated from multiples of the length of the bay between the centers of uprights, plus dimension 'z' in Table 12. Dimension z accounts for the length of pipe needed to go through the topmost fitting to the fitting's termination. This also applies to constructions using fitting Type 45.

Longitudinal pipes are joined using fittings Type 14 or 18 couplings (use of Type 18 is not recommended as a load bearing joint), which must be positioned to occur at the edge of the Type 46 fitting, and must not all occur in the same bay at alternate levels.

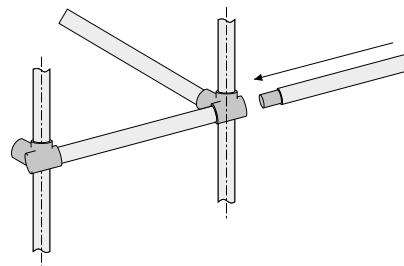

Spigots can be either pipes or rods, riveted into position, or the Type 18 fitting. When using the latter, a gap of 3/4" must be allowed for the set screw fixing.

Base and Wall Fixings*

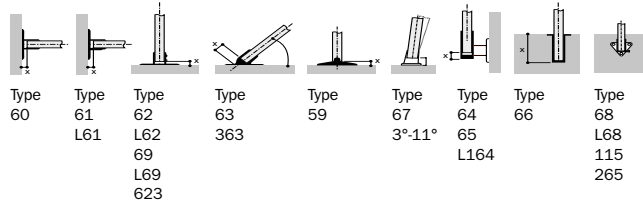

Table 13

Flange Type	x (in.)
59	-0.39
60	-0.39
61	-0.24
62	-0.24
67	-0.24
623	-0.47

Table 13 gives details of the ground fixing dimension 'x', to be subtracted from the height 'H' to give the length of the upright 'h'.

Table 14

Angle	x (in.)
45°	-1.5
50°	-1.25
60°	-1
65°	-0.5

Table 14 gives details of the ground fixing dimension 'x', for Type 63-6 only, to be subtracted to give the length of the upright for each angle condition.

Table 15

Angle	x (in.)
11°	-1.5
15°	-1.26
20°	-0.98
25°	-0.79
30°	-0.47

Table 15 gives details of the ground fixing dimension 'x' for Type 363, to be subtracted to give the length of the upright for each angle condition.

Table 16

Fitting Size	x (in.)
6	-0.25
7	-0.25
8	-0.25

Table 16 gives the dimension 'x' to be subtracted from the length of the upright for fitting Types 64, 65, 67, 68, 115, 265, L68 and L164.

Table 17

Fitting Size	x (in.)
6	+4.5
7	+5
8	+5

Table 17 gives the ground fixing dimension 'x', to be added to the upright member to allow for the setting into the socket Type 66.

*When using Kee Lite bases and flanges, "ground fixing" dimension (x) will be zero, except when using flanges L164, L68 and LC58.

Constructing Circles and Triangles

Worked Example

Slopes and radii present no problem to the Kee Klamp Galvanized railing systems. Fitting Types 27, 28, 29, 30, C50, C51, C52, 55, 56, 86, 87, 88 and 89 (and the 90 range pedestrian guardrail fittings) are designed to allow for raked handrail while keeping the uprights vertical. Pipe can be bent and radiused to suit most situations. Also, true lengths have to be determined where braces and struts are being used.

Consider the following concrete single flight staircase.

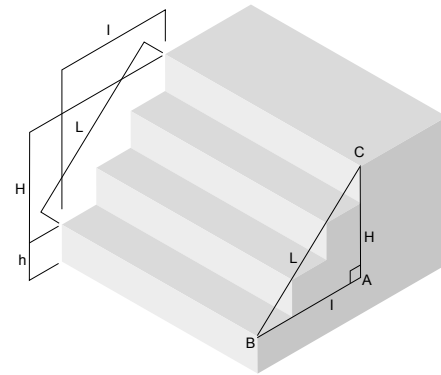

Where

H = Vertical height from 1st nosing to last nosing.

h = Vertical height from ground level to 1st nosing.

I = Horizontal dimension from 1st nosing to last nosing.

L = Hypotenuse dimension (Pitch Line) from 1st nosing to last nosing.

Known Data	Formula for Side and Angle		
H & L	$I = \sqrt{L^2 - H^2}$	$\sin B = \frac{H}{L}$	$C = 90^\circ - B$
L & I	$H = \sqrt{L^2 - I^2}$	$\sin C = \frac{I}{L}$	$B = 90^\circ - C$
H & I	$H = \sqrt{H^2 - I^2}$	$\tan B = \frac{H}{I}$	$C = 90^\circ - B$

Note: The table can be used to solve angles and true lengths for braces and struts.

Step 1

From a simple site survey or information from a working drawing, obtain the following dimensions.

Note: For greater accuracy, vertical dimensions should be taken by means of a Dumpy Level or a Theodolite.

H = vertical height from the 1st nosing to the last (140cm).

L = pitch line, the diagonal dimension from the 1st nosing to the last (240cm).

Step 2

From the table to determine angle B we use;

$\sin B = 55 / 96$, Angle $B = 35^\circ$

Ramps can be dealt with in a similar way. Most ramps have a stated gradient (e.g. 1:1.2); for every 12 units traversed horizontally, 1 unit of vertical height is obtained.

How to Make Jigs for Railing Posts

Set-up

Step 1

Start with pre-cut pipe.

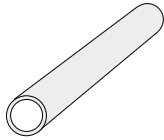

Step 2

Measure and locate fittings on first post only.

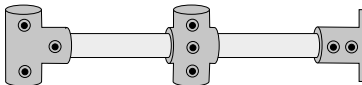

Step 3

Lay post horizontal, and insert two pieces of scrap pipe. This is all that's involved in setting up your jig! From this point, duplicate posts can be produced by unskilled labor, without further measuring, at the rate of 20-30 posts per hour.

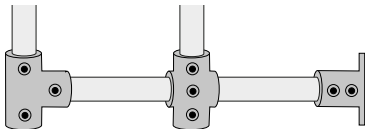

Utilising Jigs for Railing Posts

Production

Step 1

Set top and middle fittings in place, unfastened, on the two pieces of scrap pipe.

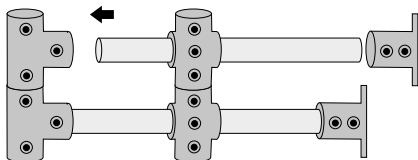

Step 2

Insert pre-cut pipe into fittings, then add flange.

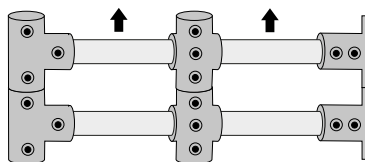

Step 3

Simply tighten set screws, then lift off.

Wire Mesh Infill

Infilling is normally constructed from 2" x 2" 0.13", 1" x 1" x 0.13" or 2" x 1" x 0.13" wire mesh welded to a 0.31" Rod frame, and is fixed into position using standard Fitting Types 81 and 82. (NB: Types 81 and 82 require cut outs on mesh less than 1.26" square.)

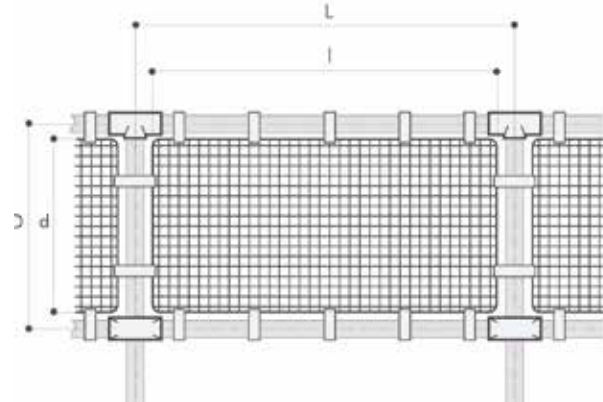

Table 20

Fitting Size	x (in.)
5	-2.36
6	-2.99
7	-3.39
8	-3.50
9	-3.86

Table 20 gives the dimensions to be subtracted from the centre dimensions 'L' and 'D' of the structure to give the formulae $l = L - x$ and $d = D - x$.

Warning: The spacing of panel clip Types 81 and 82 should not exceed 17.72" centers. The safety attachment incorporated in the panel clip Types 81 and 82 cannot be used with mesh less than 1.26".

Pipe Bending



Table 21

Fitting Size	R (in.)
3	2.24
4	2.24
5	3.54 or 3.86
6	4.02
7	5.31
8	5.98
9	7.99

Table 21 gives details of standard radius 'R' of the pipe bent by Kee Safety Ltd. If the standard radii below are not suitable, pipe sizes 5 to 9 can be rolled to any radius above a minimum of 19.69".

Galvanized Racking Load Tables

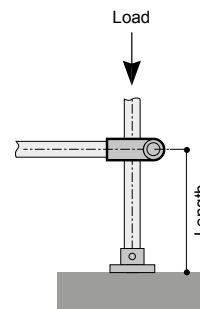
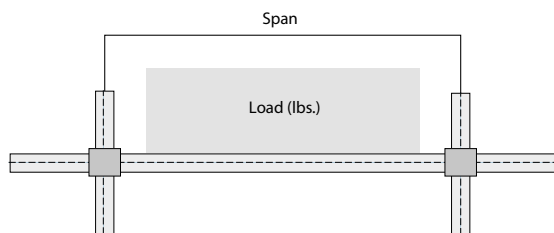

Table 22
Beam load tables (lbs.)

Span	Fitting Size				
	5	6	7	8	9
	Pipe Size				
	3/4" N.B.	1" N.B.	1-1/4" N.B.	1-1/2" N.B.	2" N.B.
1'	1658	3123	5516	7669	13180
2'	829	1562	2758	3834	6590
3'	553	1041	1838	2556	4393
3' 6"	474	892	1576	2191	3766
4'	414	781	1379	1917	3295
4' 6"	368	694	1226	1704	2929
5'	332	625	1103	1534	2636
5' 6"	302	568	1003	1394	2396
6'	277	520	919	1278	2197
6' 6"	255	481	849	1180	2028
7'	237	446	788	1096	1883
7' 6"	221	417	735	1023	1757
8'	207	390	690	959	1648
9'	184	347	613	852	1464
10'	166	313	551	767	1318

Table 22 gives an indication only of the safe load, uniformly distributed, in pounds, that may be carried per shelf consisting of front and back pipes when used as continuous beams.

For uneven load distributions or single spans, the required pipe size must be determined by standard bending moment calculations assuming a Kee Klamp joint to give a simply supported beam.

At loads greater than 2000lbs. consideration must be given to set screw slip.

Table reflects a safety factor of 1.67:1

Table 23
Load table (lbs.) – unfixed upright

Span	Fitting Size				
	5	6	7	8	9
	Pipe Size				
	3/4" N.B.	1" N.B.	1-1/4" N.B.	1-1/2" N.B.	2" N.B.
1'	1868	3243	4445	5238	7738
1' 3"	1633	2958	4213	4955	7398
1' 6"	1420	2673	3875	4650	7160
1' 9"	1213	2375	3630	4395	6785
2'	995	2108	3335	4138	6448
2' 3"	840	1813	3048	3883	6210
2' 6"	700	1583	2753	3570	5848
2' 9"	603	1395	2505	3243	5575
3'	-	1220	2170	2985	5180
3' 3"	-	1078	1993	2698	4863
3' 6"	-	948	1810	2418	4525
3' 9"	-	-	1643	2250	4218
4'	-	-	1488	2065	3880
4' 3"	-	-	1313	1880	3675
4' 6"	-	-	1215	1698	3303
4' 9"	-	-	-	1560	3123
5'	-	-	-	1450	2918
5' 3"	-	-	-	-	2693
5' 6"	-	-	-	-	2523
5' 9"	-	-	-	-	2398
6'	-	-	-	-	2150
6' 3"	-	-	-	-	2048
6' 6"	-	-	-	-	1878
6' 9"	-	-	-	-	-
7'	-	-	-	-	-

Table 23 gives an indication only of the safe load, in pounds, that may be carried between the above restraints by single pipes to BS EN 10255 (ISO 65) when used as uprights.

At loads greater than 2000lbs. consideration must be given to set screw slip.

Table reflects a safety factor of 2:1

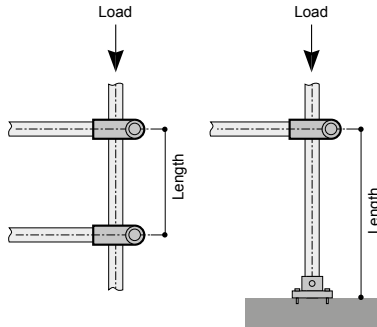

Table 24
Load tables (lbs.) – fixed uprights

Span	Fitting Size				
	5	6	7	8	9
	Pipe Size				
	3/4" N.B.	1" N.B.	1-1/4" N.B.	1-1/2" N.B.	2" N.B.
1'	2045	3390	4635	5403	7975
1' 3"	1855	3183	4445	5235	7635
1' 6"	1633	2958	4213	4955	7443
1' 9"	1493	2705	3948	4730	7160
2'	1283	2480	3715	4500	6843
2' 3"	1058	2245	3470	4268	6685
2' 6"	953	2020	3273	4003	6355
2' 9"	823	1780	2993	3730	6063
3'	700	1583	2703	3523	5835
3' 3"	635	1435	2563	3283	5520
3' 6"	-	1288	2283	3083	5270
3' 9"	-	1160	2085	2858	4978
4'	-	1025	1938	2603	4818
4' 3"	-	-	1783	2393	4503
4' 6"	-	-	1643	2225	4218
4' 9"	-	-	1488	2098	3958
5'	-	-	1363	1920	3675
5' 3"	-	-	1270	1785	3415
5' 6"	-	-	-	1698	3268
5' 9"	-	-	-	1520	3088
6'	-	-	-	1450	2918
6' 3"	-	-	-	-	2715
6' 6"	-	-	-	-	2578
6' 9"	-	-	-	-	2398
7'	-	-	-	-	2263
7' 3"	-	-	-	-	2150
7' 6"	-	-	-	-	2048
7' 9"	-	-	-	-	1913
8'	-	-	-	-	-
8' 3"	-	-	-	-	-

Table 24 gives an indication only of the safe load, in pounds, that may be carried between the above restraints by single pipes when used as uprights.

At loads greater than 2000lbs. consideration must be given to set screw slip (*rating includes a safety factor of 2:1).

Table reflects a safety factor of 2:1

Aluminum Racking Load Tables

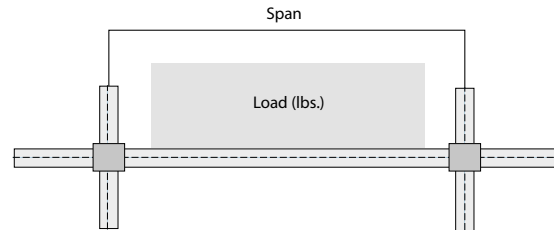

Table 25
Beam load table (lbs.)

Span	Fitting Size			
	6	7	8	9
	Pipe Size			
	1" N.B.	1-1/4" N.B.	1-1/2" N.B.	2" N.B.
1'	3081	3413	10369	17966
2'	984	2198	3494	7510
3'	438	975	1551	3337
3' 6"	321	717	1141	2453
4'	245	548	872	1877
4' 6"	-	434	690	1483
5'	-	352	557	1200
5' 6"	-	291	462	992
6'	-	243	386	833
6' 6"	-	208	329	710
7'	-	178	283	613
7' 6"	-	-	248	534
8'	-	-	217	469
9'	-	-	171	370
10'	-	-	-	300

Values shown have a safety factor of 2 built into them and are based on the limit state of the material used.

The values in Table 25 are an indication of a UDL that a rack consisting of two continuous support pipes can support.

For uneven load distributions, the required pipe size must be determined by standard bending moment and deflection calculations assuming the Kee Lite joint to give a simply supported beam.

At loads greater than 1700 lbs.* consideration must be given to grubscrew slippage. (*A safety factor of 2 being applied in this instance.)

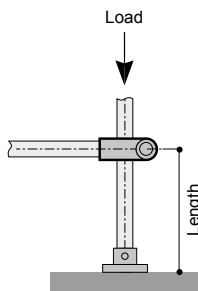

Table 26

Load tables (lbs.) – unfixed upright bases

Span	Fitting Size			
	6	7	8	9
	Pipe Size			
	1" N.B.	1-1/4" N.B.	1-1/2" N.B.	2" N.B.
1'	5359	9201	11573	16274
1' 3"	3644	7651	10126	15418
1' 6"	2858	5811	8101	14639
1' 9"	1965	4358	6944	13082
2'	1107	3390	5381	11291
2' 3"	893	2808	4340	8487
2' 6"	714	1598	3761	7397
2' 9"	589	1307	2777	6073
3'	553	1113	2488	5295
3' 3"	464	1017	2198	4516
3' 6"	393	871	1157	4282
3' 9"	-	774	1099	3504
4'	-	726	868	3192
4' 3"	-	678	839	2803
4' 6"	-	629	787	1635
4' 9"	-	-	693	1323
5'	-	-	608	1227
5' 3"	-	-	-	1168
5' 6"	-	-	-	1027
5' 9"	-	-	-	973
6'	-	-	-	894
6' 3"	-	-	-	814
6' 6"	-	-	-	774
6' 9"	-	-	-	-
7'	-	-	-	-

Values shown have a safety factor of 2 built into them and are based on the limit state of the material used.

Table 26 gives an indication only of the safe load, in pounds, that may be carried between the above restraints by single Schedule 40 pipe when used as uprights.

Table reflects a safety factor of 2:1

At loads greater than 1700 lbs. consideration must be given to grubscrew slippage (a safety factor of 2 being included in this instance).

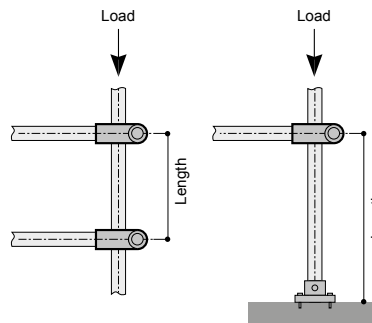

Table 27

Load tables (lbs.) – uprights restrained both ends

Span	Fitting Size			
	6	7	8	9
	Pipe Size			
	1" N.B.	1-1/4" N.B.	1-1/2" N.B.	2" N.B.
1'	7825	11138	13367	18299
1' 3"	7432	10557	13020	17909
1' 6"	6967	10412	12615	17754
1' 9"	5788	9685	12152	17286
2'	5288	9201	11573	16975
2' 3"	4430	8329	11284	16352
2' 6"	3859	7506	10589	15573
2' 9"	3037	6537	9143	15418
3'	2679	5714	7985	14561
3' 3"	2429	4939	7407	13627
3' 6"	2072	4261	6828	12848
3' 9"	1858	4068	5960	12069
4'	-	3390	5497	11291
4' 3"	-	3147	4918	10512
4' 6"	-	2905	4340	8721
4' 9"	-	2663	3935	8409
5'	-	2373	3587	7631
5' 3"	-	2179	3356	6852
5' 6"	-	-	3182	6073
5' 9"	-	-	2835	5606
6'	-	-	2604	5295
6' 3"	-	-	-	5061
6' 6"	-	-	-	4750
6' 9"	-	-	-	4516
7'	-	-	-	3971
7' 3"	-	-	-	3815
7' 6"	-	-	-	3504
7' 9"	-	-	-	3348
8'	-	-	-	-
8' 3"	-	-	-	-

Values shown have a safety factor of 2 built into them and are based on the limit state of the material used.

Table 27 gives an indication only of the safe load, in pounds, that may be carried between the above restraints by single Schedule 40 pipe when used as uprights.

Table reflects a safety factor of 2:1

At loads greater than 2000lbs. consideration must be given to grubscrew slippage (a safety factor of 2 being included in this instance).

Test Report:

Vibration of Kee Klamp® Assemblies

Exhaustive tests on samples of standard size 7 Kee Klamp fittings were performed by an independent research laboratory. The purpose of the test was to evaluate the use of either standard set screws or self-locking set screws.

Test Arrangement

A "Tee" section test assembly was made using three 12 ft. lengths of Galvanized size 7 standard pipe held together by a three socket tee fitting (Type 25-7). The vertical leg of the test assembly was supported in a standard railing flange (Type 62-7). The completed assembly was then rigidly attached to the vibration table.

The test assembly was initially assembled using standard set screws and tested in this configuration. The standard set screws were then replaced with the self-locking screws and the tests repeated.

Test Procedure

The test was conducted on a Ling 667Kg Electromagnetic Vibration Table. The table was programmed to perform a resonance search between 25 and 350Hz and resonant frequencies were recorded and shown in Table 28.

Table 28

Test Results

Resonance Frequencies	Q Factor	Running Time
74	1.27	Nil
106	1.27	Nil
158	1.53	6 hours
200	1.8	6 hours
221	5	6 hours
295	9	6 hours

During the resonance search, amplification factors (Q) were measured at each resonant frequency, the point of reference being the end of one horizontal pipe. The table was then held at one of the resonant frequencies, set in motion with a controlled acceleration level of 4g, and ran for a period of six hours. This was repeated for three more resonant frequencies in descending order of Q factor.

Furthermore, during the twenty-four hours of vibration at the four resonant frequencies above, no signs of loosening with either type of attachment screw occurred.

Comprehensive data showing the telescopic relationship between pipes to BS EN 10255 (ISO 65) is shown in Table 29.

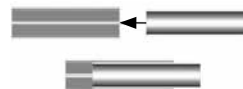

Table 29

Telescopic relationship between pipes to BS EN 10255 (ISO 65)

Size 9 heavy	Will accept 8 heavy or medium
Size 9 medium	Will accept 8 heavy or medium
Size 8	No telescopic relationship Requires special spigotting material
Size 7 heavy	Will only accept size 6 light
Size 7 medium	Will accept size 6 light, medium and heavy
Size 6 heavy	No telescopic relationship Requires special spigotting material
Size 6 medium	Will only accept size 5 light
Size 5 heavy	No telescopic relationship Requires special spigotting material
Size 5 medium	No telescopic relationship Requires special spigotting material
Size 4	No telescopic relationship Requires special spigotting material
Size 3	No telescopic relationship Requires special spigotting material

Keep Safety: Your Fall Protection Experts

At Kee Safety, education is the foundation of safety. Our team is dedicated to assisting you with every aspect of your project, regardless of its scope. We work closely with you to customize our Fall Protection Systems to meet your requirements and ensure the safety of your employees, contractors, and facility. Our commitment to your safety doesn't end with installation—we'll be there at every step, from system inspection and assessment to ongoing service requirements.

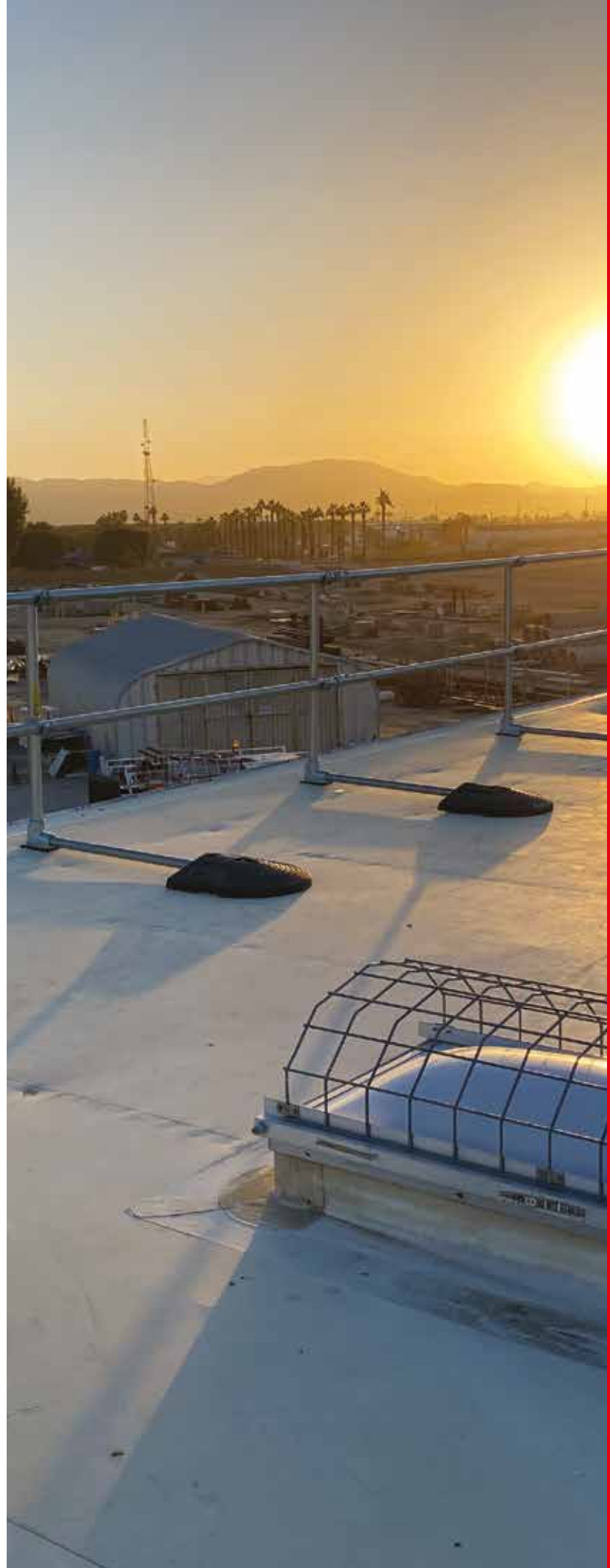



Kee Safety Inc.
100 Stradtman Street
Buffalo, NY 14206

Tel: (716) 896-4949

Toll Free: (800) 851-5181

Fax: (716) 896-5696

Email: info@keesafety.com

Web: www.keesafety.com

KEE KLAMP and KEE LITE are registered trademarks of Kee Safety Inc. While every effort has been made to ensure the accuracy of the information contained in this brochure, Kee Safety Inc cannot be held responsible for any errors or omissions. Kee Safety Inc. reserves the right to alter or withdraw products without prior notice. Kee Safety Inc accepts no responsibility for any loss or damage arising from improper use of its products. Copyright © 2024 Kee Safety Inc. All Rights Reserved.