



RELIABLE SAFE ACCESS

Single and Double Gates Operation & Maintenance Manual







SAFETY GATES

KEE GATE is a complete range of safety gates designed specifically to provide permanent hazard protection for internal or external applications.

KEE GATE can provide permanent protection for any openings, ladder/stair access points, roof hatches and restricted areas, where regular access for maintenance & inspection is required. The gates have been specifically designed to provide a “retro-fit” solution to existing fixed structures where opening protection is required. The U-bolt connection allows each gate to be connected to posts from 33.7 – 48.3mm (1” – 1.5” USA version).

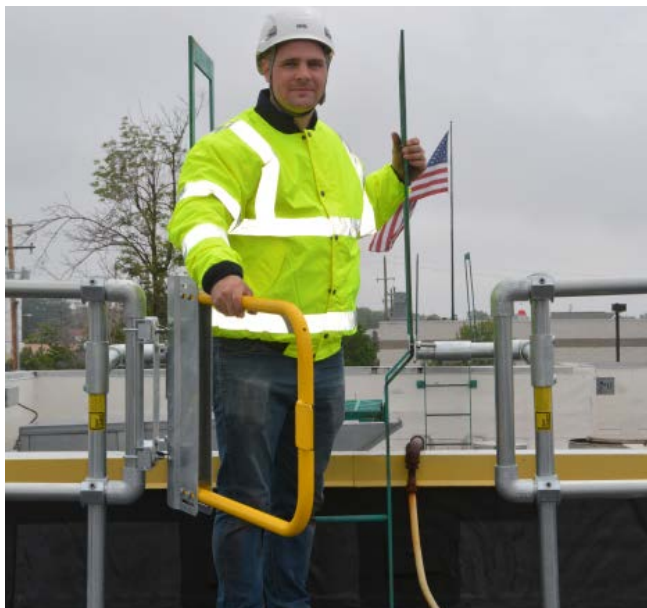

APPLICATION

KEE GATE has been designed to be fully adjustable and can accommodate openings up to 1m (USA 18” – 48”) for single gate and 1.8m (70.86”) for the double gate. Connecting the “KEE GATE ” to the supporting structure/post/stringer is simple via using the U-bolt which can provide connection around any flat, square or tubular stringer from 33.7 – 48.3mm (1” – 1.5”).

DURABILITY

KEE GATE is available in a range of high quality finishes. Galvanised: components are supplied with a galvanised finish to BS EN ISO 1461 and ASTM A53: Hot Dip Galvanised Coatings Specification and Testing Methods, giving an average coating of between 55-100 microns. Aluminium: products are supplied to Grade 6082 T6, & T4, Anodised Stainless Steel: products are supplied to Grade 316.



COMPONENT BASED SYSTEMS

All products consist of high quality tubing that seamlessly compliments our existing safety portfolio. KEE GATE mounts easily to all variants of the KEE KLAMP & KEEGUARD systems as well as Safe Access Solutions such as Mobile Access Platforms & Static Access Platforms.

VERSATILE SYSTEMS

The KEE GATE range has been specially designed with U-bolt clamps allowing the products to be mounted to the supporting structure/post/stringer. This permits connection around any flat, square or tubular stringer from 33.7 – 48.3mm (1” – 1.5”).



TESTING & CERTIFICATION

Tested in accordance with the following (See Specification Section for full details) :-

EN 13374 Class A.

EN ISO 14122 Part 3 & Part 4

OSHA

ANSI

Ontario Building Code, NBC and British Columbia Building Code

Canadian Standards Association

Canada Occupational Health and Safety

LIFE CYCLE TESTING - BS 6375-2:2009 Clause 6.5 - Opening and closing of Gate through 90 degrees.

SALT SPRAY TESTING - ASTM B117 - 11 - 55 over 200 hours to assess performance of coating to resist corrosion.

OFFICIAL DOCUMENTATION

All Systems comply with the following:-

Work at Height Regulations.

HSG 33 "Health & Safety in Roof work"

HSE Construction Sheet No. 21 "Working on flat roofs protection against falls."

European Union Directives together with requirements of CDM Regulations. USA & Canada.

AESTHETICS

The smooth lines of the standard galvanised finish can be further enhanced by the application of powder coating to EN 13438.

USA-AAMA 2603-2605.

SYSTEMS DISTRIBUTORS

KEE GATE is available as a supply and installation service or component supply only. Products are available from Kee Safety directly or one of its licensed distributors.

PRODUCT SPECIFICATION – EUROPEAN – USA - CANADIAN

FEATURES:- Spring Loaded, self-closing safety gate.

GENERAL

KEE GATE systems require physical fixing to the buildings structure.

The complete system's design, manufacture, testing and installation have been externally assessed and tested to European – USA – Canadian Standards.

MATERIALS

European Single & Double Gate

Steel tubing to EN 10255. 33.7mm diameter tube x 3.2mm wall thickness.

All steel components galvanised to BS EN ISO 1461.

All fixings are hot dipped galvanised to BS EN ISO 1461.

All cast clamps have Threadcoat applied to all tapped holes. All grub screws are carbon steel and have Keekoat protection applied to ensure minimal maintenance.

Where tubing is cut on site zinc rich paint is applied to the cut end of the tube.

Powder Coating to EN 13438.

USA & Canada

All steel components galvanised steel to ASTM A53.

All fixings are hot dipped galvanised to ASTM A53.

Powder Coating to USA-AAMA 2603-2605.

SINGLE GATE LAYOUT EUROPE & CANADA

Recommended installed height of KEE GATE is 1.1m in Europe and Canada depending on the structure it is fixed to and National Regulations . Standard gate width 1m. Internal gap between top and bottom guardrail 466mm. Guardrail centre to centre 500mm. Double gate width 900mm. Internal gap between top and bottom guardrail 466mm. Guardrail centre to centre 500mm

SINGLE GATE LAYOUT USA

Recommended installed height of KEE GATE is 42" in the USA depending on the structure it is fixed to and National Regulations.

Standard gate widths 18", 21", 24", 27", 30", 33", 36", 40", 48" (each model can be adjusted on site) Internal gap between top and bottom guardrail 18.35".

Guardrail centre to centre 19.69".

DOUBLE GATE LAYOUT (EU, CANADA & USA)

Recommended installed height of KEE GATE is 1.1m in Europe and Canada depending on the structure it is fixed to and National Regulations .Guardrail centre to centre 500mm. Double gate width 900mm. Internal gap between top and bottom guardrail 466mm. Guardrail centre to centre 500mm

TESTING

EN ISO 14122 Part 3 & Part 4

EN 13374 Class A

OSHA – 200 lb applied to the top rail of the gate and 150 lb on the mid-rail of the gate

ANSI – The gate must comply with the same loading requirements as the structure to which it is attached.

IBC – designed to resist linear load of 50 lb/ft

Ontario Building Code, NBC and British Columbia Building Code – “Handrails and any building element that could be used as handrail shall be designed and attached in such a manner to resist, (a) a concentrated load at any point of not less than 0.9 kN (202 lb) and a uniformly distributed load of 0.7 kN/m (48 lb/ft).

OBC and NBC state – “all other guards” – 0.75 kN/m (52 lb/ft) or concentrated load of 1.0 kN (224 lb) applied at any point on top of the guard

Evenly distributed vertical load on top of the guard – 1.5 kN/m (103 lb/ft)

Canadian Standards Association – 0.9 kN (202 lb), 0.7 kN/m (48 lb/ft) – states “Guard - a protective barrier around an opening in a floor or at the open side of stairs, a landing, balcony, mezzanine, gallery, raised walkway or other location; used to prevent accidental falls from one level to another; such a barrier may or may not have openings through it.”

Canada Occupational Health and Safety – 890N applied along top rail (200 lb)

LIFE CYCLE TESTING - BS 6375-2:2009 Clause 6.5 - Opening and closing of Gate through 90 degrees.

SALT SPRAY TESTING - ASTM B117 - 11 - 55 over 200 hours to assess performance of coating to resist corrosion.

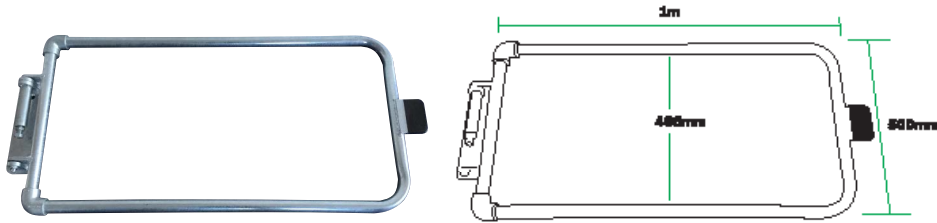

European Gate - Galvanised - SGEU500GV

Spring Loaded, self-closing safety gate. Manufactured from steel to EN 10255. 33.7mm diameter tube x 3.2mm wall thickness to meet requirements of EN 13374 & EN 14122. Complete with fixing pack.

Material : Galvanised steel to BS EN ISO 1461. Net weight : 11kg (24lb 4oz).

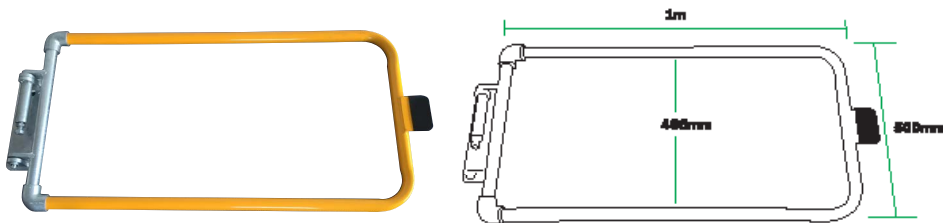

European Gate - Powder Coated - SGEU500PC

Spring Loaded, self-closing safety gate. Manufactured from steel to EN 10255 33.7mm diameter tube x 3.2mm wall thickness to meet requirements of EN 13374 & EN 14122. Complete with fixing pack. Powder Coated Finish to EN 13438.

Material : Steel to EN 10255. Net weight : 11kg (24lb 4oz).

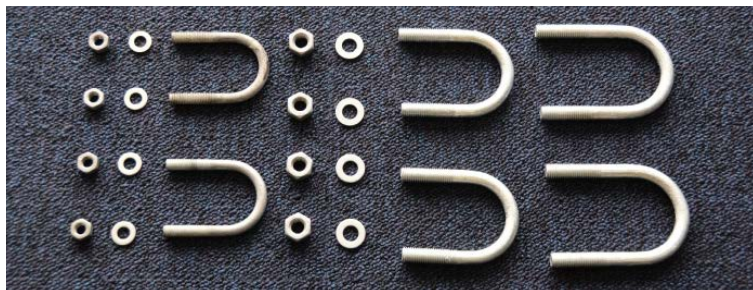

SAFETY GATE EUROPEAN FIXING PACK 1 - SGEUFXPK1

Supplied for the European market to fit posts 33.7mm, 42.4mm and 48.3mm diameter. Fixing pack contains 3No U Bolts for each size complete with M8 and M10 nuts and washers.

Material : Galvanised steel to BS EN ISO 1461. Net weight : 0.864kg (1lb 14oz).

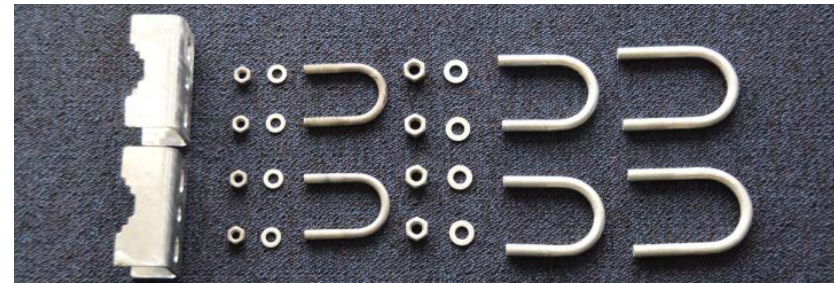

SAFETY GATE NORTH AMERICAN FIXING PACK 1 - SGNAFXPK1

Supplied for the USA market to fit posts 1.0", 1.25" and 1.5" diameter. Fixing pack contains 3No U Bolts for each size complete with 0.3125" and 0.375" nuts and washers.

Material : Galvanised steel to ASTM A53. Net weight : 1.44kg (3lb 3oz).



Single Gate Components - North America

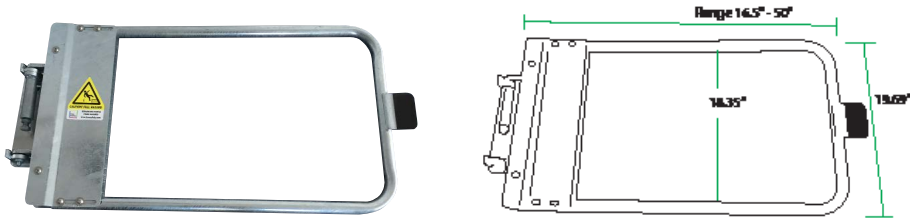

NORTH AMERICAN GATE - GALVANISED

Spring Loaded, self-closing safety gate for North America. Each model can be adjusted on site without need for cutting or welding. Complete with fixing pack.

Material : Galvanised steel to ASTM A53.

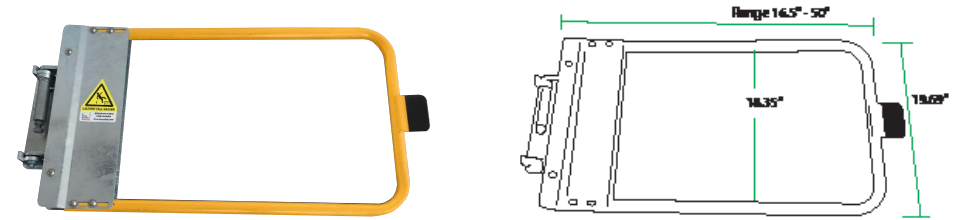

NORTH AMERICAN GATE - POWDER COATED

Spring Loaded, self-closing safety gate for North America. Each model can be adjusted on site without need for cutting or welding. Complete with fixing pack.

Powder Coated USA - AAMA 2603-2605.

Material : Galvanised steel to ASTM A53.

IMPERIAL

Single Safety Gate - Imperial					
Part No.	Description	Min (in)	Mid (in)	Max (in)	Weight (lbs)
SGNA018GV	18" Gate - Galvanised	16.5	18	20	37lbs 10oz
SGNA018PC	18" Gate - Powder Coated				
SGNA021GV	21" Gate - Galvanised	19.5	21	23	38lbs 11oz
SGNA021PC	21" Gate - Powder Coated				
SGNA024GV	24" Gate - Galvanised	22.5	24	26	38lbs 13oz
SGNA024PC	24" Gate - Powder Coated				
SGNA027GV	27" Gate - Galvanised	25.5	27	29	39lbs 15oz
SGNA027PC	27" Gate - Powder Coated				
SGNA030GV	30" Gate - Galvanised	28.5	30	32	41lbs oz
SGNA030PC	30" Gate - Powder Coated				
SGNA033GV	33" Gate - Galvanised	31.5	33	35	41lbs 3oz
SGNA033PC	33" Gate - Powder Coated				
SGNA036GV	36" Gate - Galvanised	34.5	36	38	42lbs 5oz
SGNA036PC	36" Gate - Powder Coated				
SGNA040GV	40" Gate - Galvanised	38.5	40	42	43lbs 3oz
SGNA040PC	40" Gate - Powder Coated				
SGNA048GV	48" Gate - Galvanised	46.5	48	50	44lbs 15oz
SGNA048PC	48" Gate - Powder Coated				

METRIC

Single Safety Gate - Metric					
Part No.	Description	Min (mm)	Mid (mm)	Max (mm)	Weight (kg)
SGNA018GV	18" Gate - Galvanised	418	457	508	16.8
SGNA018PC	18" Gate - Powder Coated				
SGNA021GV	21" Gate - Galvanised	494	533	584	17.2
SGNA021PC	21" Gate - Powder Coated				
SGNA024GV	24" Gate - Galvanised	570	610	660	17.5
SGNA024PC	24" Gate - Powder Coated				
SGNA027GV	27" Gate - Galvanised	647	686	737	17.9
SGNA027PC	27" Gate - Powder Coated				
SGNA030GV	30" Gate - Galvanised	723	762	813	18.3
SGNA030PC	30" Gate - Powder Coated				
SGNA033GV	33" Gate - Galvanised	799	838	889	18.6
SGNA033PC	33" Gate - Powder Coated				
SGNA036GV	36" Gate - Galvanised	875	914	965	19.0
SGNA036PC	36" Gate - Powder Coated				
SGNA040GV	40" Gate - Galvanised	977	1016	1067	19.4
SGNA040PC	40" Gate - Powder Coated				
SGNA048GV	48" Gate - Galvanised	1180	1219	1270	20.3
SGNA048PC	48" Gate - Powder Coated				



Double Gate - Galvanised - **SGDBPEUGV / SGDBPNAGV**

Spring Loaded, self-closing safety gate. Manufactured from steel to EN 10255. 33.7mm diameter tube x 3.2mm wall thickness to meet requirements of EN 13374 & EN 14122. Specify SGDBPEUGV to include European fixing pack or SGDBPNAGV for NA fixing pack. Material : Galvanised steel to BS EN ISO 1461 ASTM A53. Net weight : 25kg (55lb 12oz).



Double Gate - Powder Coated - **SGDBPEUPC / SGDBPNAPC**

Spring Loaded, self-closing safety gate. Manufactured from steel to EN 10255 33.7mm diameter tube x 3.2mm wall thickness to meet requirements of EN 13374 & EN 14122. Complete with fixing pack. Powder Coated Finish to EN 13438. Specify SGDBPEUPC to include European fixing pack or SGDBPNAPC for NA fixing pack. Material : Steel to EN 10255. Net weight : 25kg (55lb 12oz).

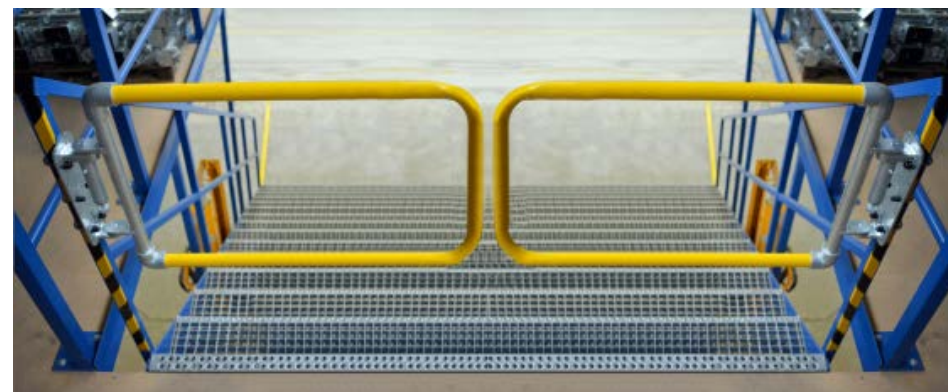

SAFETY GATE EUROPEAN FIXING PACK 1 - **SGEUFXPK2**

Supplied for the European market to fit posts 33.7mm, 42.4mm and 48.3 mm diameter. Fixing pack contains 3No. U Bolts for each size complete with M8 and M10 nuts and washers. Material : Galvanised steel to BS EN ISO 1461. Net weight : 1.30kg (2lb 14oz).

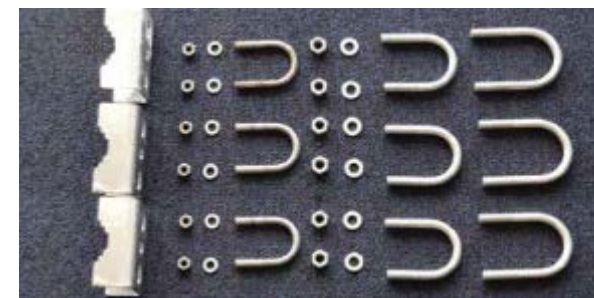

SAFETY GATE NORTH AMERICAN FIXING PACK 1 - **SGNAFXPK2**

Supplied for the North American market to fit posts 1.0", 1.25" and 1.5" diameter. Fixing pack contains 3No. U Bolts for each size complete with 0.3125" and 0.375" nuts and washers. Material : Galvanised steel to ASTM A53. Net weight : 2.16kg (4lb 12oz).

TOOLS REQUIRED

You will need the following in order to install the Kee Gate:

- Marker Pen
- Tape Measure
- 1No 24mm Ring Spanner
- 1No 13mm socket
- 1No 17mm socket
- 1No 24mm socket
- ¼" Hex Key Socket
- Torque Wrench 10- 60 Nm approx
- Hacksaw or Similar
- Small Magnetic Level

Mounting Gate to Upright

**Establish that the gate will close in direction of hazard!!
Failure to do so could result in Death or serious injury.**

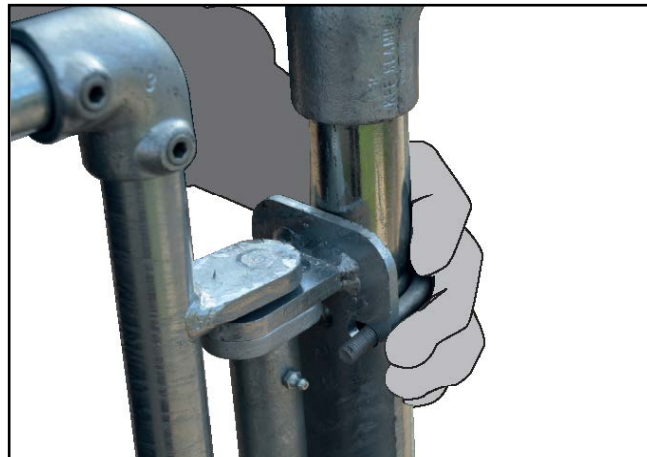

A. Align the fixing plate on internal face of the opening, so that the rails of the Safety Gate match up with the top of the Guardrail System. Select the correct U Bolt & pass around the support leg/structure and feed through the top holes of the fixing plate.



B. Using a M8 or M10 flat washer and nut connect the U bolt to the Support Leg/Structure and tighten.

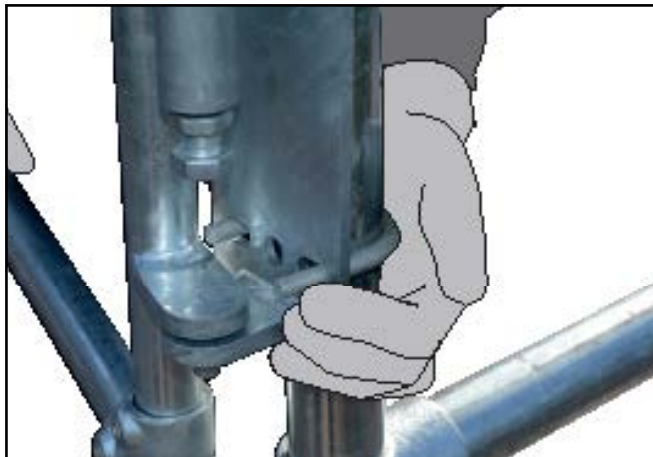

C. Pass U-Bolt around the support leg/structure and feed through the bottom holes of the fixing plate.

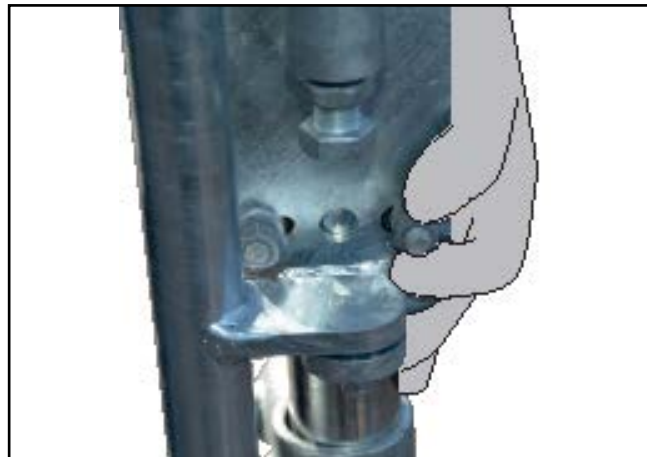

D. Using a M8 or M10 flat washer and nut connect the U bolt to the Support Leg/Structure and tighten.



E. Torque all nuts/U Bolts to 25Nm using the 13mm or 17mm socket and torque wrench.

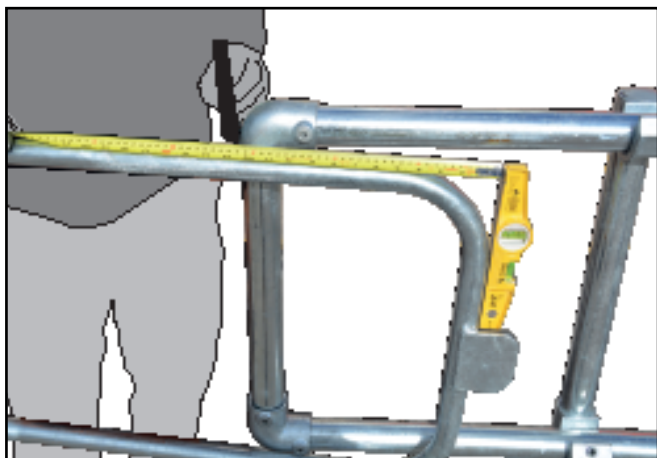

F. To cut the gate to the correct size simply place a straight edge/magnetic level as shown and measure the distance to the point where the outside edge of the vertical tube meets the supporting structure as shown. **(DO NOT CUT AT THIS MARK!)**

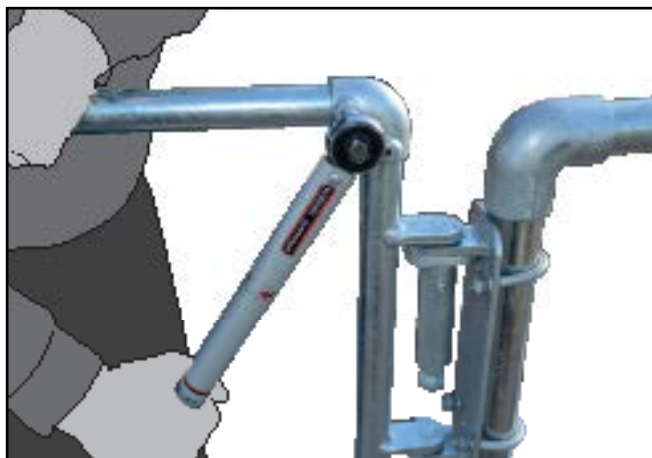

G. Disconnect the tubular gate from the hinge assembly by loosening the top & bottom cast clamp grub screw using a hex head socket as shown.

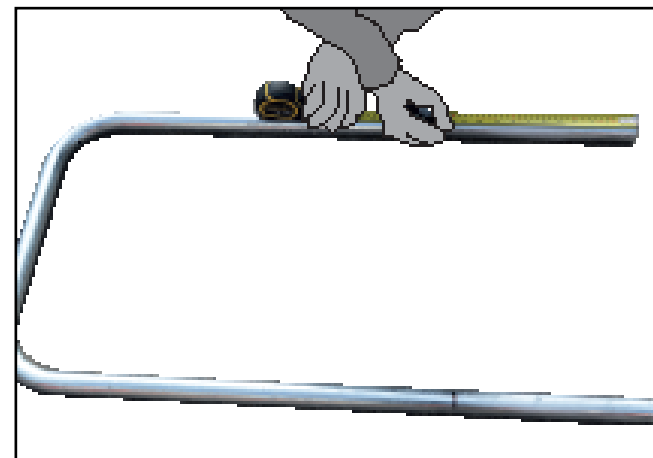

H. Measure the distance recorded in point (f) above and mark the gate top and bottom tubes as shown.

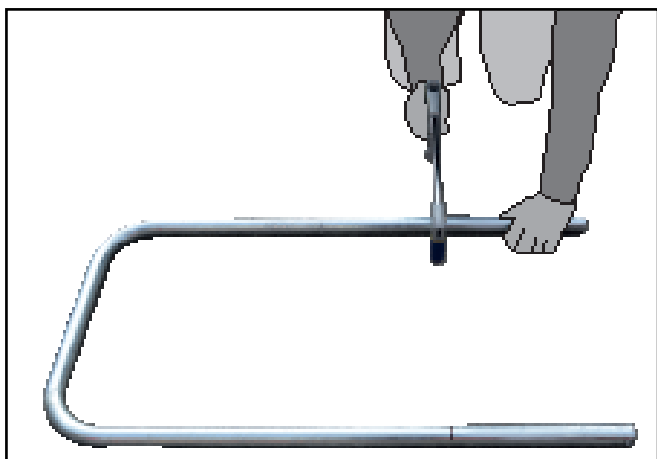

I. Using a hacksaw or similar carefully cut through the top and bottom tubes as shown. For galvanised assemblies, spray with Galvafoid or similar to prevent corrosion.

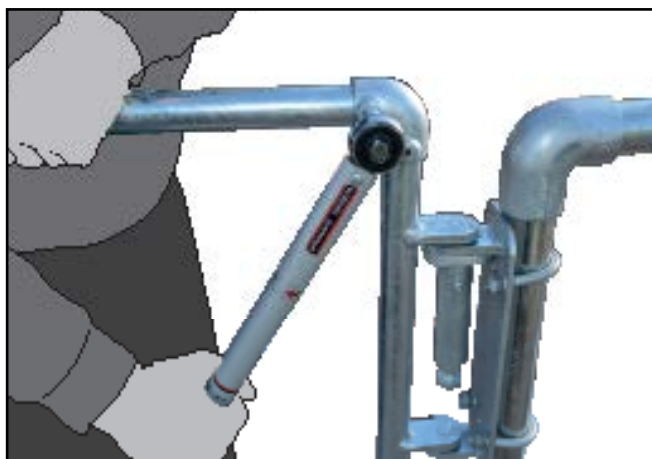

J. Carefully re-position the gate top and bottom tubes into the cast fittings. Ensure the striking plate is on the correct side of the Support Leg/Structure. Use a spirit level, to ensure the gate is level. Tighten the cast fittings grub screws using a hex head socket. Using the torque wrench ensure the castings are torqued to 39Nm.

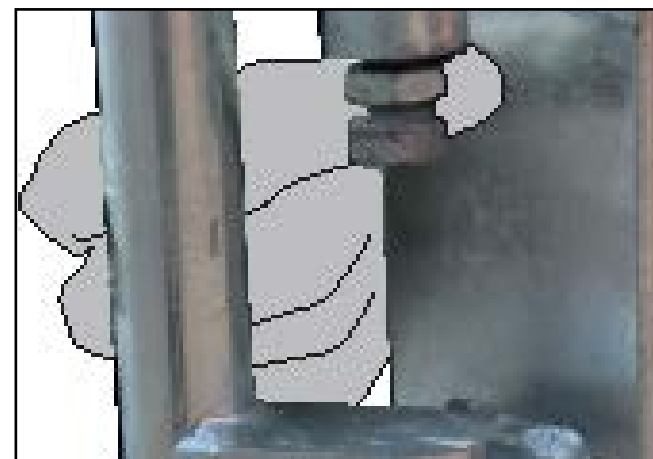

K. To tension the hinge loosen the locking nut as shown.



L. Manually open the gate at 45 degrees from its closed position.

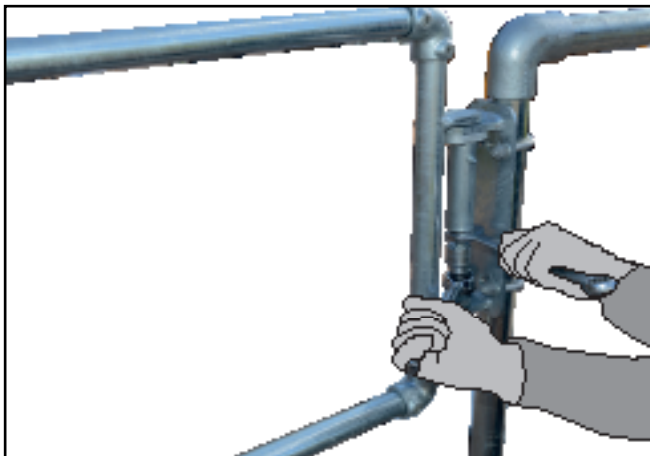

M. Using the 24mm socket & ring spanner start to tighten the bolt until the gate completely closes. (Note:- You may have to hold the socket whilst using the ratchet).

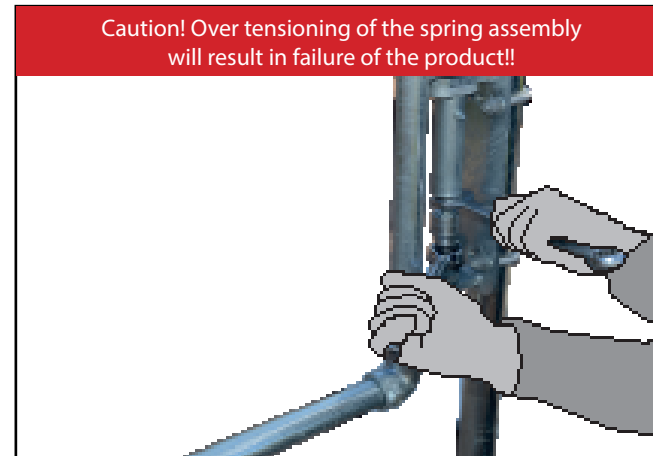

Caution! Over tensioning of the spring assembly will result in failure of the product!!

N. Once the gate is completely closed tighten the locking nut to hold the tension. Caution:- Continue to hold the ratchet firmly and do not release until the lock nut is tightened. Now remove the socket and spanner from the hinge. Repeat as necessary, to ensure that the gate closes sufficiently, once opened and released.



Note:- Installing Kee Gate

When installing Kee Gate on a pitched roof it is essential that the gate is mounted vertically level to the horizontal. This can be accommodated by using standard 90 degree Elbows (15-8) (4No required per gate).

The elbows permit adjustment allowing the Kee Gate to be orientated to the correct angle. If the gate is not set at the correct angle the hinge cannot be tensioned correctly and the gate may not close as required.



TOOLS REQUIRED

You will need the following in order to install the Kee Gate:

- Marker Pen
- Tape Measure
- 1 No 15/16" Ring Spanners
- 3/16" Allen Key
- 1 No 1/2" socket
- 1 No 11/16" socket
- 1 No 15/16" socket
- Torque Wrench 10- 60 Nm approx
- Small Magnetic Level

Mounting Gate to Upright

**Establish that the gate will close in direction of hazard!!
Failure to do so could result in Death or serious injury.**



A. Align the fixing plate on internal face of the opening, so that the rails of the Safety Gate match up with the top of the Guardrail System. Select the correct U Bolt & pass it through the Steel Safety Clamp & around the support leg/structure and feed through the top holes of the fixing plate.



B. Using a 11/16" or 1/2" flat washer and nut connect the U bolt to the Support Leg/Structure and tighten.

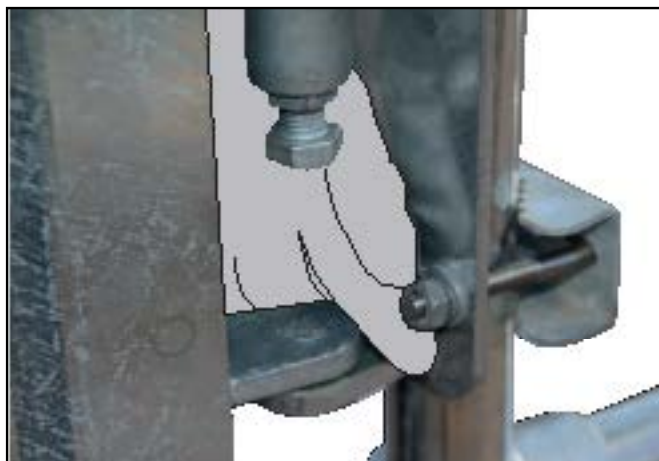

C. Select the correct U Bolt & pass it through the Steel Safety Clamp & around the support leg/structure and feed through the top holes of the fixing plate. Using a 1/2" or 11/16" flat washer and nut connect the U bolt to the Support Leg/Structure and tighten.



D. Torque all nuts/U Bolts to 25Nm using the 11/16" or 1/2" socket and torque wrench.

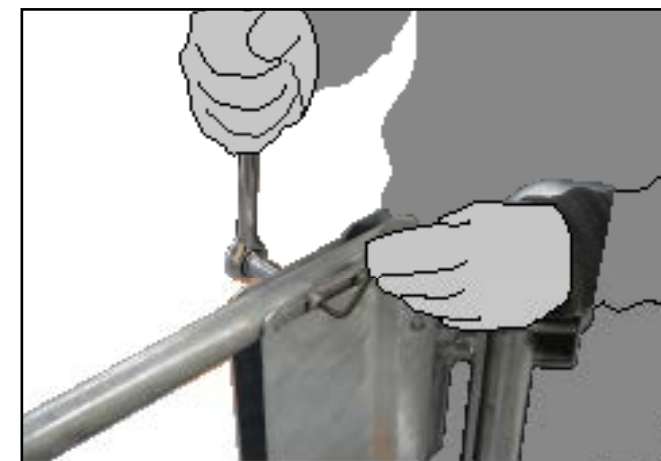

E. To extend the gates width to the required opening simply loosen the hex nuts and bolts on the top guardrail using a 3/16" Allen Key and 1/2" socket.

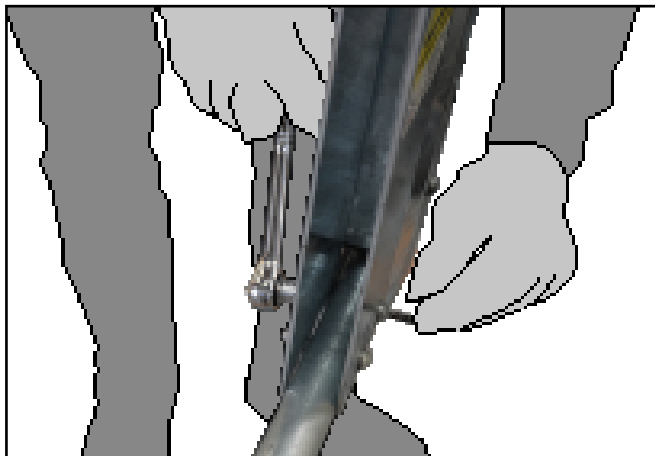

F. To extend the gates width to the required opening simply loosen the hex nuts and bolts on the bottom guardrail using a 3/16" Allen Key and 1/2" socket.

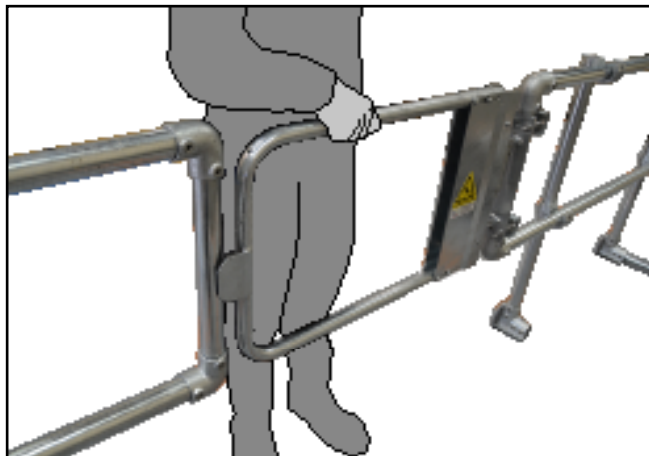

G. Establish the additional distance required so the striking plate strikes the required post.

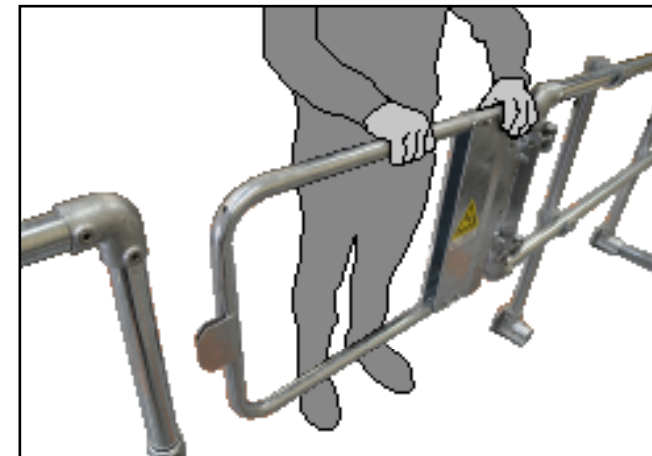

H. Extend the gate by pulling to the required distance.

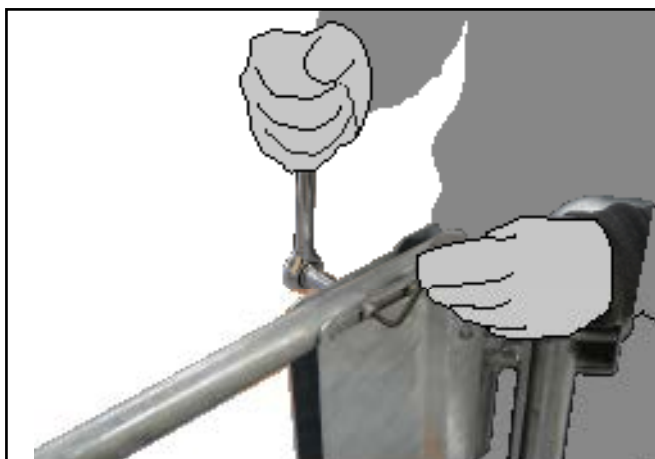

I. Once the gate is lined and levelled tighten the hex nuts and bolts on the top & bottom guardrails using a 3/16" Allen Key and 1/2" socket.

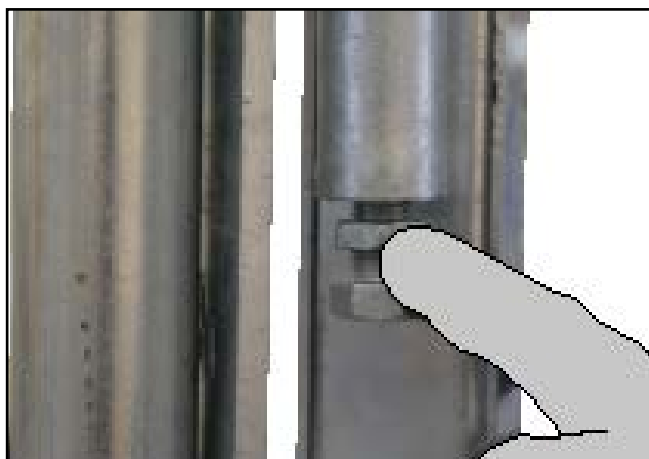

J. To tension the hinge loosen the locking nut as shown.

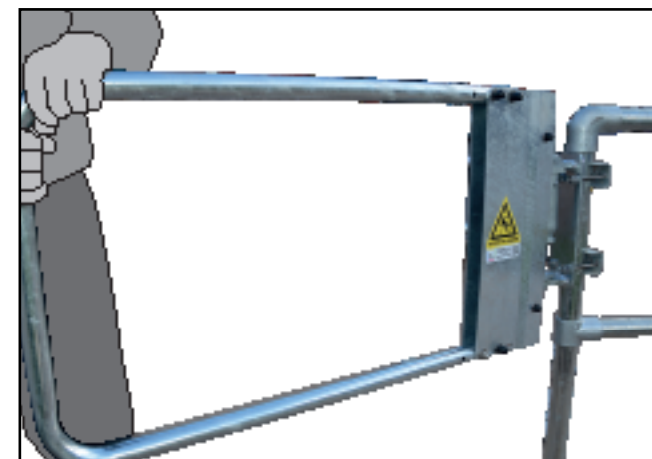

K. Manually open the gate at 45 degrees from its closed position.



L. Using the 15/16" socket & ring spanner start to tighten the bolt until the gate completely closes. (Note:- You may have to hold the socket whilst using the ratchet).

Caution! Over tensioning of the spring assembly will result in failure of the product!!



M. Once the gate is completely closed tighten the locking nut to hold the tension. Caution:- Continue to hold the ratchet firmly and do not release until the lock nut is tightened. Now remove the socket and spanner from the hinge. Repeat as necessary, to ensure that the gate closes sufficiently, once opened and released.



Note:- Installing Kee Gate

When installing Kee Gate on a pitched roof it is essential that the gate is mounted vertically level to the horizontal. This can be accommodated by using standard 90 degree Elbows (15-8) (4No required per gate). The elbows permit adjustment allowing the Kee Gate to be orientated to the correct angle. If the gate is not set at the correct angle the hinge cannot be tensioned correctly and the gate may not close as required.

TOOLS REQUIRED

You will need the following in order to install the Kee Gate:

- Marker Pen
- Tape Measure
- 1No 10mm Ring Spanner
- 1No 24mm Ring Spanner
- 1No 13mm socket
- 1No 17mm socket
- 1No 24mm socket
- 1No 4mm Hex Key
- ¼" Hex Key Socket
- Torque Wrench 10- 60 Nm approx
- Hacksaw or Similar
- Small Magnetic Spirit Level

Mounting Gate to Upright

**Establish that the gate will close in direction of hazard!!
Failure to do so could result in Death or serious injury.**



A. Align the fixing plate on internal face of the opening, so that the rails of the Safety Gate match up with the top of the Guardrail System. Select the correct U Bolt & pass around the support leg/structure and feed through the top holes of the fixing plate.



B. Using a M8 or M10 flat washer and nut connect the U bolt to the Support Leg/Structure and tighten.



C. Pass U-Bolt around the support leg/structure and feed through the middle holes of the fixing plate. Using a spring washer, flat washer and nut to connect the U bolt to the fixing plate.



D. Pass U-Bolt around the support leg/structure and feed through the bottom holes of the fixing plate. Using a spring washer, flat washer and nut to connect the U bolt to the fixing plate.



E. Torque all nuts/U Bolts to 39Nm using the 13mm or 17mm socket and torque wrench.
Repeat steps A-D for right hand side gate.

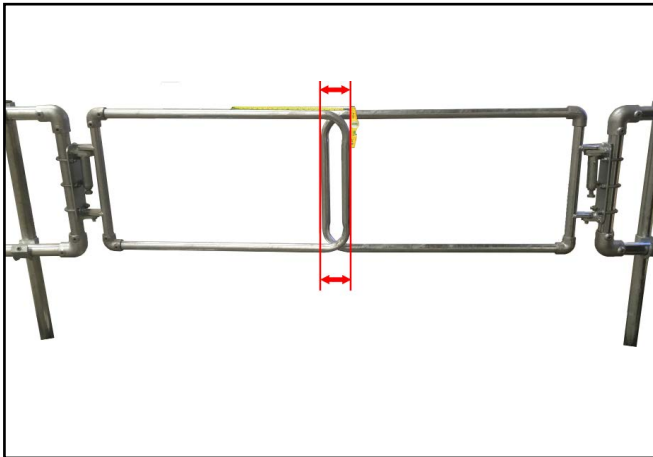

F. To cut the gate to the correct size simply place a straight edge/magnetic level as shown and measure and record the distance to the point where the outside edge of the vertical tubes overlap as shown. **(DO NOT CUT AT THIS MARK!)**



G. Disconnect the tubular gate from the hinge assembly by loosening the top & bottom cast clamp grub screw using a hex head socket as shown.

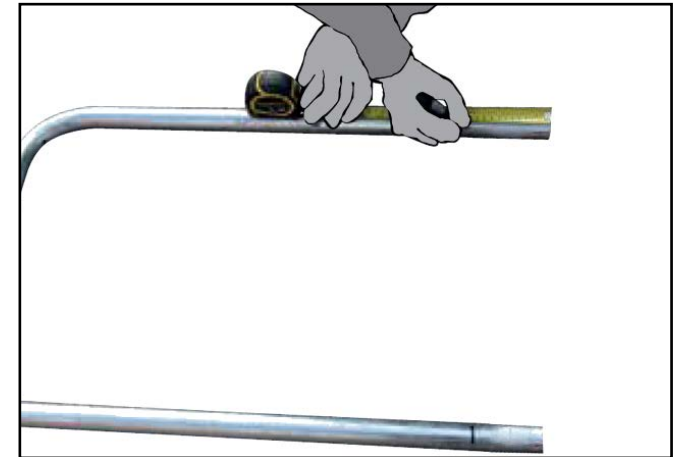

H. Divide the distance recorded in step **F** by 2, mark this measurement on gate top and bottom tubes as shown. This measurement is to be removed from both gates to ensure both gates are the same width.

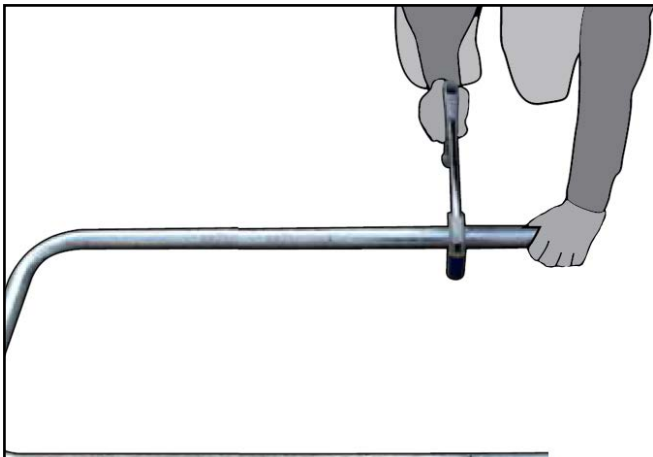

I. Using a hacksaw or similar carefully cut through the top and bottom tubes as shown. For galvanised assemblies, spray with Galvafoid or similar to prevent corrosion.



J. Carefully re-position the gate top and bottom tubes into the cast fittings. Use a spirit level, to ensure the gate is level. Tighten the cast fittings grub screws using a hex head socket. Using the torque wrench ensure the castings are torqued to 39Nm. **Repeat steps G-J for right hand gate.**

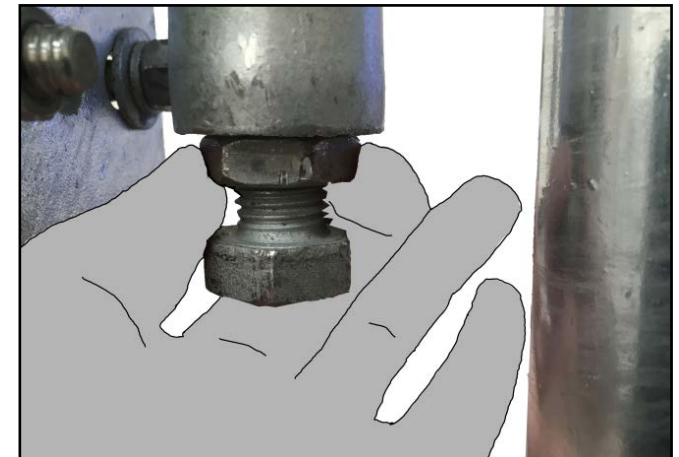

K. To tension the hinge loosen the locking nut as shown.

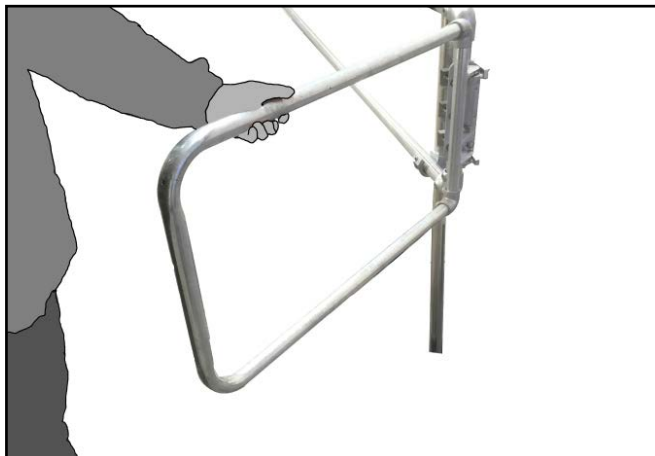

L. Manually open the gate at 45 degrees from its closed position.

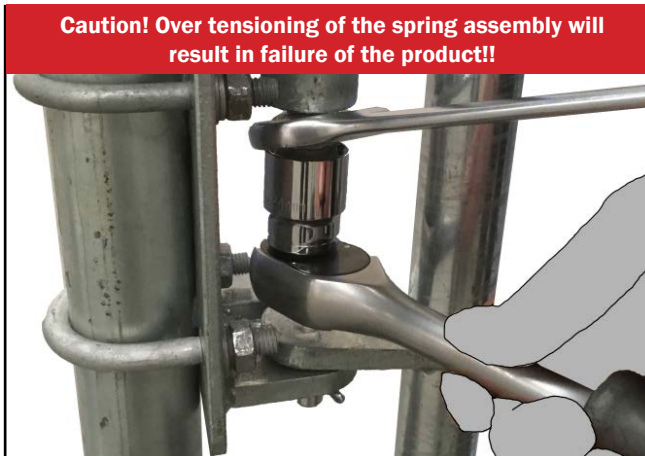

M. Using a 24mm socket & spanner tighten the bolt until the gate completely closes. (You may have to hold the socket whilst using the ratchet). Once the gate is completely closed tighten the locking nut to hold the tension. Caution:- Hold ratchet firmly and do not release until the lock nut is tightened. Repeat as necessary to ensure that the gate closes sufficiently.

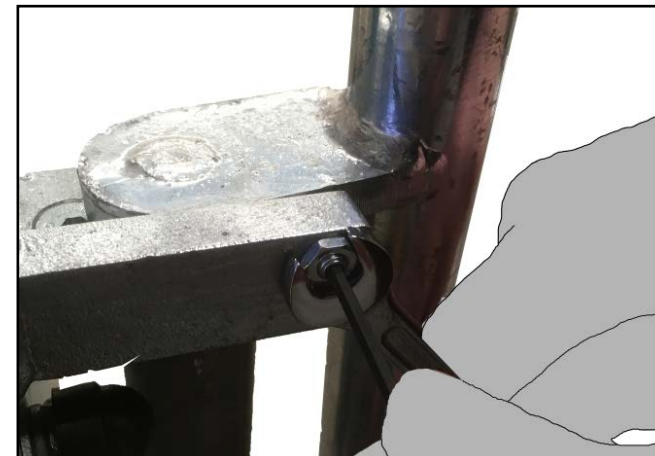

N. Using a M6 spanner and 4mm hex key, slacken off the locking nut and adjust the grub screws so that the gate leaves meet in the middle. Once centre position is correct, lock off grub screw using nut.

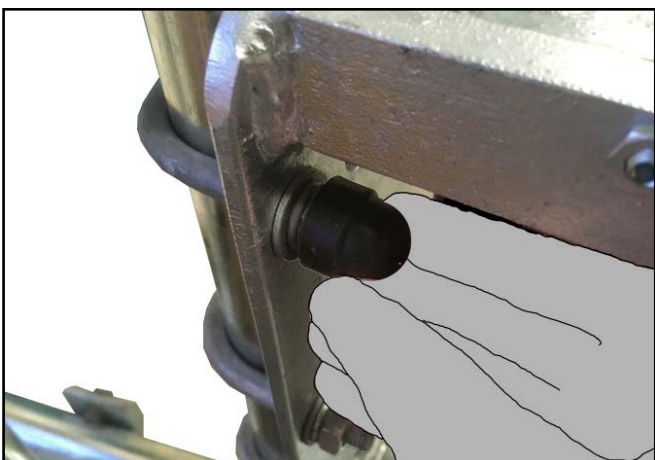

N. Ensure all nuts and grub screws (excluding adjustment screw) on the gate are torqued to 39Nm. Finally, place black caps over nuts. Ensure that the structure to which the gate is attached to is sturdy, does not rotate and nuts and grub screws are torqued as per manufacturers guidelines.



Note:- Installing Kee Gate

When installing Kee Gate on a pitched roof it is essential that the gate is mounted vertically level to the horizontal. This can be accommodated by using standard 90 degree Elbows (15-8) (4No required per gate).

The elbows permit adjustment allowing the Kee Gate to be orientated to the correct angle. If the gate is not set at the correct angle the hinge cannot be tensioned correctly and the gate may not close as required.



TOOLS REQUIRED

You will need the following in order to install the Kee Gate:

- Marker Pen
- Tape Measure
- 1No 3/8" Ring Spanner
- 1No 5/32" Ring Spanner
- 1No 15/16" Ring Spanner
- 1No 3/16" Hex Key
- 1No 1/2" socket
- 1No 11/16" socket
- 1No 15/16" socket
- Torque Wrench 10- 60 Nm approx
- Small Magnetic Spirit Level

Assembly and Mounting of Gate to Floor

Establish that the gate will close in direction of hazard!!
Failure to do so could result in Death or serious injury.

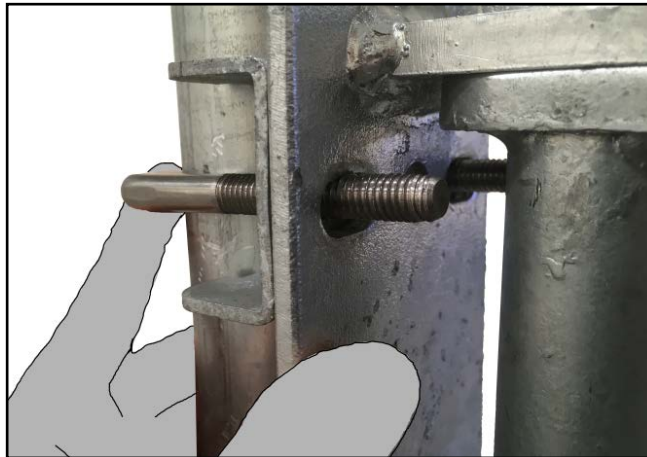

A. Align the fixing plate on internal face of the opening, so that the rails of the Safety Gate match up with the top of the Guardrail System. Select the correct U Bolt & pass it through the Steel Safety Clamp, around the support leg/structure and feed through the top holes of the fixing plate.



B. Using a 11/16" or 1/2" flat washer and nut connect the U bolt to the Support Leg/Structure and tighten.

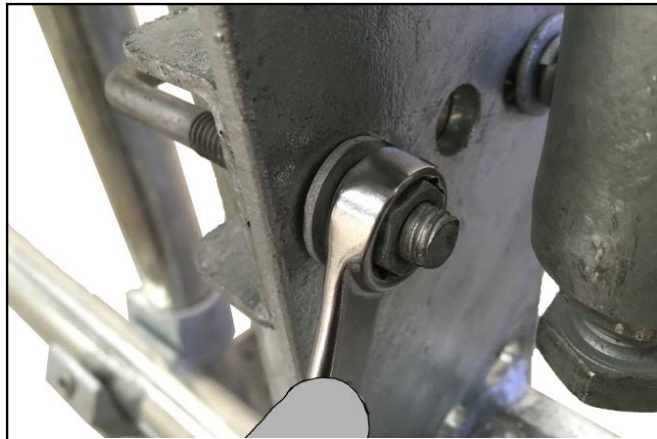

C. Select the correct U Bolt & pass it through the Steel Safety Clamp, around the support leg/structure and feed through the middle holes of the fixing plate. Using a 1/2" or 11/16" flat washer and nut connect the U bolt to the Support Leg/Structure and tighten. Repeat step for lower holes in faceplate.



D. Torque all nuts/U Bolts to 39Nm using the 11/16" or 1/2" socket and torque wrench.

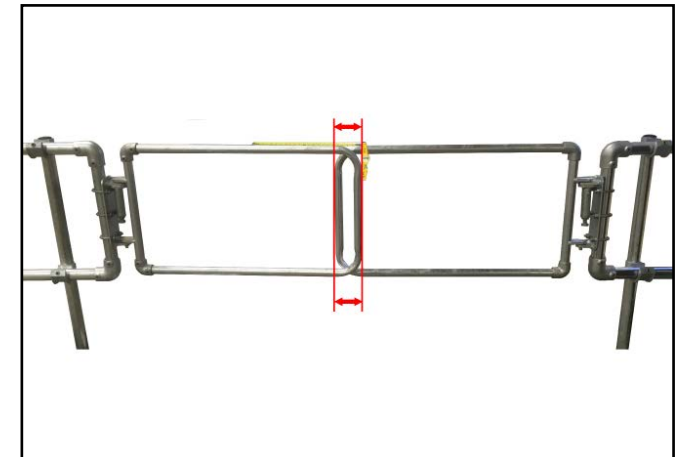

E. To cut the gate to the correct size simply place a straight edge/magnetic level as shown and measure the distance between the outside edges of the vertical tube on both gates.
(DO NOT CUT AT THIS MARK!)



F. Disconnect the tubular gate from the hinge assembly by loosening the top & bottom cast clamp grub screw, using a hex head socket as shown.

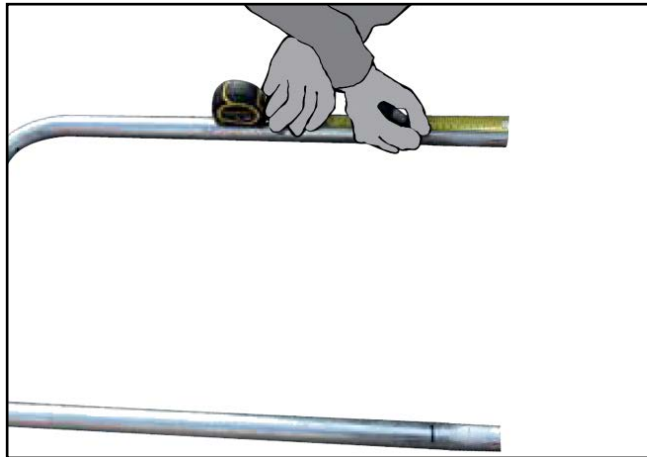

G. Divide the distance recorded in step **E** by 2, mark this measurement on gate top and bottom tubes as shown. This measurement is to be removed from both gates to ensure both gates are the same width and meet in the middle.

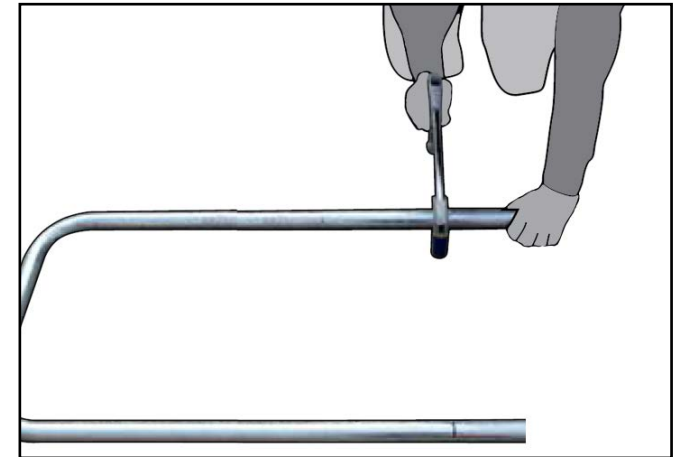

H. Using a hacksaw or similar carefully cut through the top and bottom tubes as shown. For galvanised assemblies, spray with Galvafoid or similar to prevent corrosion.



I. Carefully re-position the gate top and bottom tubes into the cast fittings. Use a spirit level, to ensure the gate is level. Tighten the cast fittings grub screws using a hex head socket. Using the torque wrench ensure the castings are torqued to 39Nm.

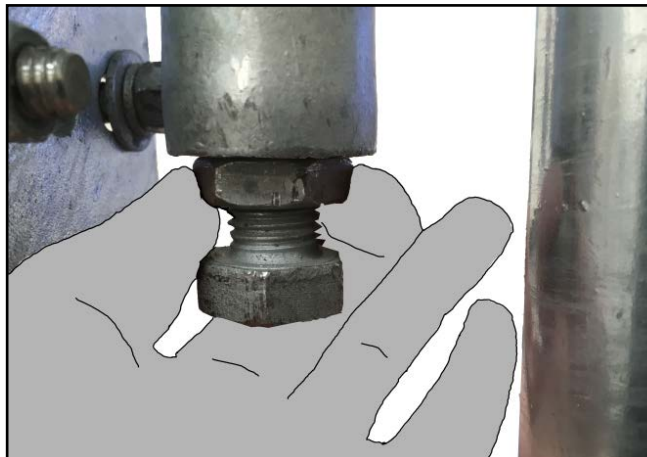

J. To tension the return spring hinge loosen the locking nut as shown.

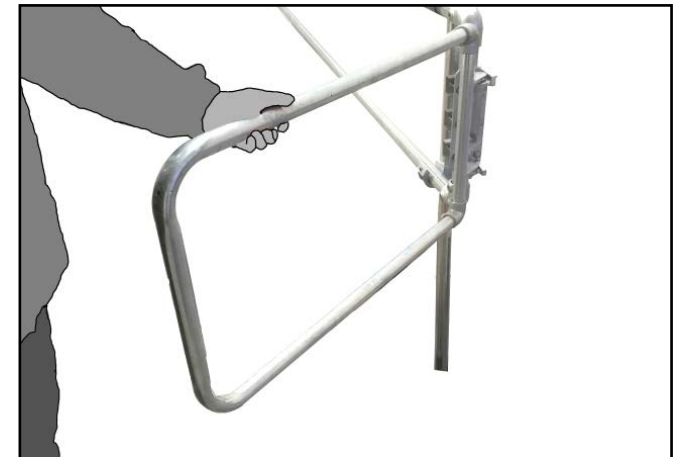

K. Manually open the gate at 45 degrees from its closed position.



Caution! Over tensioning of the spring assembly will result in failure of the product!!



L. Using the 15/16" socket & ring spanner start to tighten the bolt until the gate completely closes. (Note:- You may have to hold the socket whilst using the ratchet). Once the gate is completely closed tighten the locking nut to hold the tension. Caution:- Continue to hold the ratchet firmly and do not release until the lock nut is tightened. Now remove the socket and spanner from the hinge. Repeat as necessary, to ensure that the gate closes sufficiently, once opened and released.

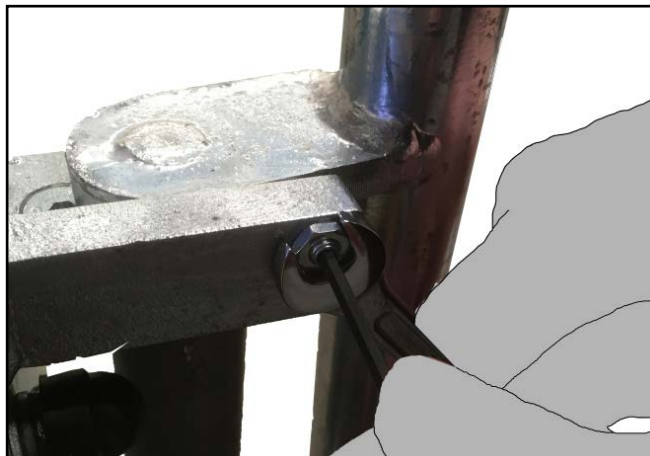

M. Using a 3/8" spanner and 3/16" hex key, slacken off the locking nut and adjust the grub screws so that the gate leaves meet in the middle. Once centre position is correct, lock off grub screw using nut.

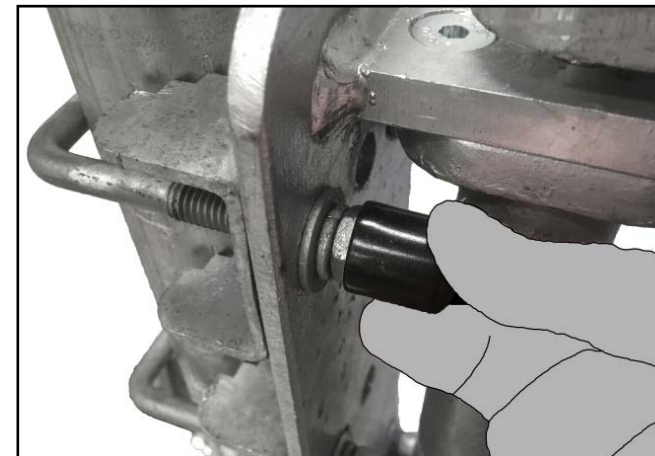

N. Ensure all nuts and grub screws (excluding adjustment screw) on the gate are torqued to 39Nm. Finally, place black caps over nuts. Ensure that the structure to which the gate is attached to is sturdy, does not rotate and nuts and grub screws are torqued as per manufacturers guidelines.



Note:- Installing Kee Gate

When installing Kee Gate on a pitched roof it is essential that the gate is mounted vertically level to the horizontal. This can be accommodated by using standard 90 degree Elbows (15-8) (4No required per gate).

The elbows permit adjustment allowing the Kee Gate to be orientated to the correct angle. If the gate is not set at the correct angle the hinge cannot be tensioned correctly and the gate may not close as required.

Periodic inspections by a competent person are recommended by the manufacturer. In UK/Europe these are required under Regulation 5 of the Workplace (Health, Safety & Welfare) Regulations, the Work at Height Regulations and Provision and Use of Work Equipment Regulations.

The frequency will depend upon the environment, location and usage but should be at least every 12 months.

- Visually inspect the complete installed product in relation to the client's needs. Establish if any modifications and/or additional products are required to reflect any refurbishment requirements or additional plant & equipment which have been installed and require access.
- Check installation configuration is complete as per the original installation drawing/plan.
- Ensure the product has not been modified or tampered with by unauthorised persons.
- Check the functionality of the product.
- Check the spring is correctly tensioned.
- Check all fixings are in place, greased and sufficiently torqued.
- Check the general height and level of the product.
- Any galvanised components showing signs of corrosion should be wire brushed thoroughly and galvanised spray/paint applied as appropriate. If rusted significantly, take digital photographs and include these in the inspection report.
- Inspect powder coated product surfaces and note any imperfections or general degradation.
- Check fixings to walls/structures including cat ladder clamps are in place, greased and sufficiently torqued.
- Check system plaque position & mark up to reflect date of the next required inspection. Establish if additional plaques are required due to any refurbishment works.



Scan this QR Code to find out more about Kee Safety products.



Kee Safety Limited
Cradley Business Park
Overend Road, Cradley Heath
West Midlands B64 7DW

Phone: +44 (0) 1384 632 188
Fax: +44 (0) 1384 632 192
sales@keesafety.com
www.keesafety.co.uk