

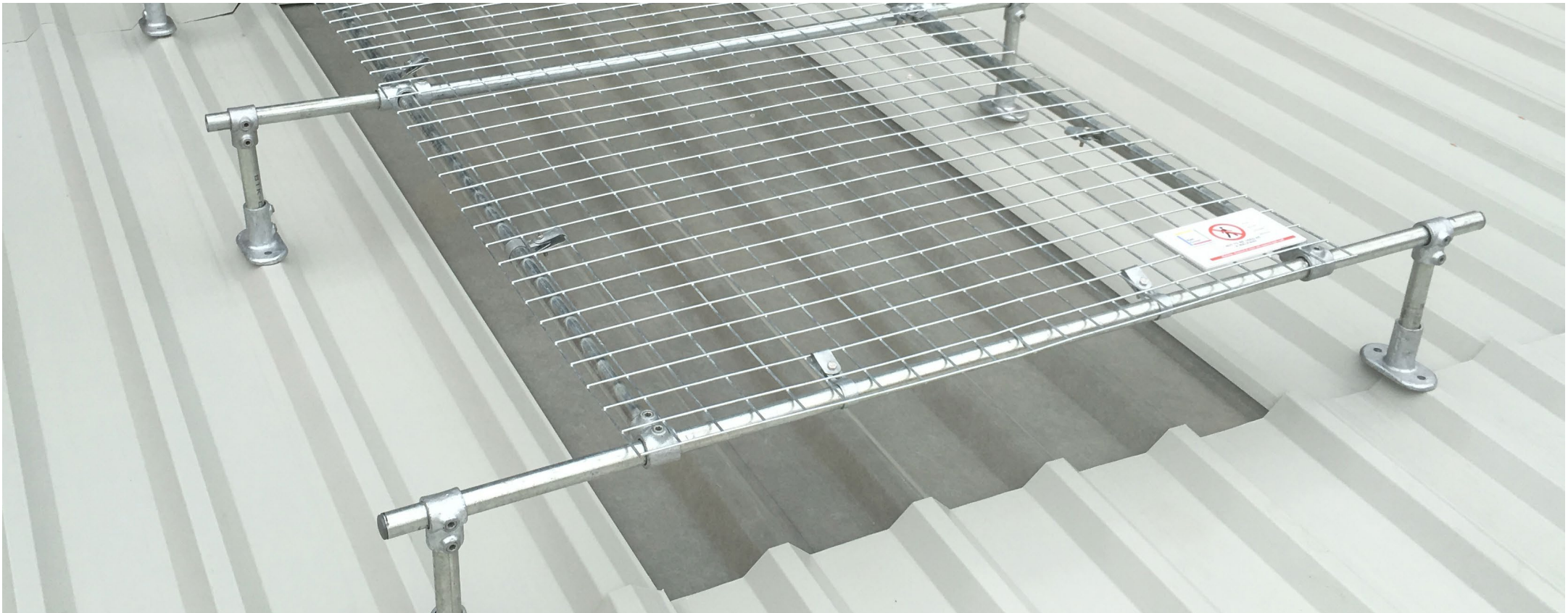

SAFETY AT THE HIGHEST LEVEL

Kee Cover Operation and Maintenance Manual





ROOFLIGHT PROTECTION

The Kee Cover® range of modular systems has been designed specifically to prevent falls through rooflights.

UNIQUE DESIGN

These innovative products provide protection for personnel accessing near fragile rooflights whilst carrying out maintenance or inspections on industrial roofs.

The Unique design means that fragile rooflights can now be quickly and easily protected.

VERSATILE

Kee Cover® uses standard Kee Klamp® fittings and standard lengths of tube to form a rigid frame. A mesh panel is mounted on the frame to prevent falls through the rooflight.



PORTABILITY

The Kee Cover® range has been designed in component form to ensure that it can be easily transported both to site and up to roof level.

PERMANENT/TEMPORARY

This versatile product can serve as either a temporary or permanent installation.

DURABILITY

The Kee Cover® range is supplied with a galvanised finish carried out to BS EN ISO 1461 : 1999 Hot Dip Galvanised Coatings. Specification and Testing Methods, giving an average coating of 40 microns.



TESTING & CERTIFICATION

The Kee Cover® System has been tested to EN 1873:2014.

The Kee Cover® has been tested to the criteria and loadings taken from the UK ACR Red Book Test For Non-Fragility of Roof Assemblies.

The test involved a 45kg (100lbs) weight free falling a distance of 1.2m (4') to reach a maximum velocity. Kee Cover® arrested the load via deformation of the wire mesh panel with no penetration of the wire mesh panel.



ROOF CLADDING PROTECTION

The Kee Cover® range uses 70-5 or 62-5 cast fittings to connect the Kee Cover to the metal sheet roof. These fittings are either fixed or clamped to the crowns of the roof using either Tek screws or, in the case of standing seam roofs KCFP1 clamps are used. To maintain water integrity a sealing strip between the cast fitting and metal sheet roof is used.

OFFICIAL DOCUMENTATION

Work at Height Regulations
HSG 33 Health & Safety in Roof work
ACR Red Book Test For Non-Fragility of Roof Assemblies
Workplace (Health, Safety and Welfare) Regulations

AESTHETICS

The smooth lines of the standard galvanised finish can be further enhanced by the application of powder coating to EN 13438.
USA-AAMA 2603-2605.

TECHNICAL BULLETIN

Polycarbonate Rooflights – Are they fragile?

Generally speaking polycarbonate rooflights are deemed to be non-fragile for the “construction phase” of a project. Once the project is handed over they are deemed as fragile due to the following:-

Non-fragility is dependent not only on the strength/durability of the rooflight material itself, but on all aspects of installation of an assembly. This may be compromised even if there is no loss of strength of the rooflight material. This is particularly true for in-plane rooflights.

Whilst polycarbonate is an extremely strong and very durable material, there are some things that can cause dramatic and very premature failure – for example, plasticisers attack polycarbonate, so contact with plastisol coated steel or, worse, PVC tape (which contains much higher levels of plasticisers) will cause premature failure; permanent stresses in the material, certain chemicals, trapped water which can heat up can also all accelerate degradation.

Industry interest groups would never recommend that non-fragility of any rooflight should be guaranteed in the long term, due to lack of control over the various factors other than strength of the rooflight that may affect non-fragility, but this is particularly true with polycarbonate where strength of the rooflight itself can be compromised if not treated correctly.

PRODUCT CODES AND DESCRIPTIONS

	Ke e Cover Panel - Raised 1 Metre Wide	Length	Width
KC21PMRA1	Ke e Cover 2x1m Primary Module - Raised	2m	1m
KC21XMRA1	Ke e Cover 2x1m Extension Module - Raised	2m	1m
KC11XMRA1	Ke e Cover 1x1m Extension Module - Raised	1m	1m
	Ke e Cover Panel - Standard 1 Metre Wide		
KC21PMST1	Ke e Cover 2x1m Primary Module - Standard	2m	1m
KC21XMST1	Ke e Cover 2x1m Extension Module - Standard	2m	1m
KC11XMST1	Ke e Cover 1x1m Extension Module - Standard	1m	1m
	Ke e Cover Panel - Raised 2 Metre Wide		
KC12PMRA2	Ke e Cover 1x2m Primary Module - Raised	1m	2m
KC12XMRA2	Ke e Cover 1x2m Extension Module - Raised	1m	2m
	Ke e Cover Panel - 2 Metre Wide		
KC12PMST2	Ke e Cover 1x2m Primary Module Wide - Standard	1m	2m
KC12XMST2	Ke e Cover 1x2m Extension Module Wide - Standard	1m	2m

PRODUCT SPECIFICATION – EUROPEAN FEATURES:-

Compliant Fall Protection Device.

GENERAL

KEE COVER requires physical fixing to the buildings structure.

The complete system's design, manufacture, testing and installation have been externally assessed and tested to European Standards.

MATERIALS

EUROPEAN

Steel tubing to EN 10255.

26.9mm diameter tube x 3.2mm wall thickness.

All steel components galvanised to BS EN ISO 1461.

All fixings are hot dipped galvanised to BS EN ISO 1461.

All cast clamps have THREDKOAT applied to all tapped holes. All grub screws are carbon steel and have KEE KOAT protection applied to ensure minimal maintenance.

Where tubing is cut on site zinc rich paint is applied to the cut end of the tube.

Powder Coating to EN 13438.

TESTING

EN ISO 1873 : 2014 Part 2

The test involved a 50kg weight free falling from a distance of 2.4m to reach a maximum velocity to create a force of 2400 Joules. The Kee Cover arrested the load via deformation of the wire mesh panel with no penetration of the wire mesh.

ACR RED BOOK STANDARD

The test involved a 45kg weight free falling from a distance of 1.2m to reach a maximum velocity. The Kee Cover arrested the load via deformation of the wire mesh panel with no penetration of the wire mesh.

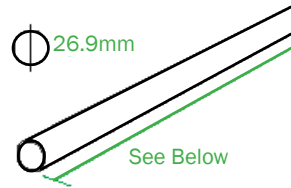

2000mm TUBING - 5210

Standard lengths supplied O/D 26.9mm : Wall thickness 3.2mm.
Material : Galvanised steel to BS EN ISO 1461. Net weight : 3kg

3000mm TUBING - 5210

Standard lengths supplied O/D 26.9mm : Wall thickness 3.2mm.
Material : Galvanised steel to BS EN ISO 1461. Net weight : 4.69kg

902mm TUBING - 5210

Standard lengths supplied O/D 26.9mm : Wall thickness 3.2mm.
Material : Galvanised steel to BS EN ISO 1461. Net weight : 1.41kg

500mm TUBING - 5210

Standard lengths supplied O/D 26.9mm : Wall thickness 3.2mm.
Material : Galvanised steel to BS EN ISO 1461. Net weight : 0.78kg

925mm TUBING - 5210

Standard lengths supplied O/D 26.9mm : Wall thickness 3.2mm.
Material : Galvanised steel to BS EN ISO 1461. Net weight : 1.45kg

1925mm TUBING - 5210

Standard lengths supplied O/D 26.9mm : Wall thickness 3.2mm.
Material : Galvanised steel to BS EN ISO 1461. Net weight : 3kg

200mm TUBING - 5210

Standard lengths supplied O/D 26.9mm : Wall thickness 3.2mm.
Material : Galvanised steel to BS EN ISO 1461. Net weight : 0.32kg

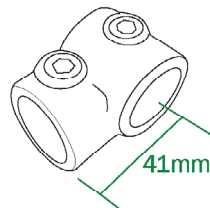

SINGLE SOCKET TEE- 10-5

This fitting is used to connect the horizontal tubing to the vertical tubing at each corner.
Material : Malleable cast iron to BS 1562 and galvanised to BS EN ISO 1461. Net weight : 0.23kg.

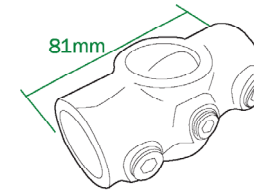

TWO SOCKET CROSS - 26-5

This fitting is used to connect the horizontal tubing to the vertical tubing in the centre of a raised panel, or to connect to an extension panel.

Material : Malleable cast iron to BS 1562 and galvanised to BS EN ISO 1461. Net weight : 0.27kg.

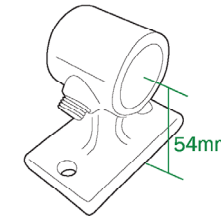

RAIL SUPPORT - 70-5

This fitting acts as feet to connect horizontal rails to the roof structure.

Material : Malleable cast iron to BS 1562 and galvanised to BS EN ISO 1461. Net weight : 0.36kg.

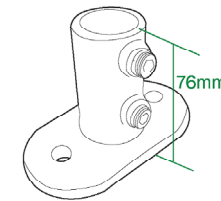

STANDARD RAILING FLANGE - 62-5

This fitting acts as feet to connect raised panels to the roof structure.

Material : Malleable cast iron to BS 1562 and galvanised to BS EN ISO 1461. Net weight : 0.59kg.

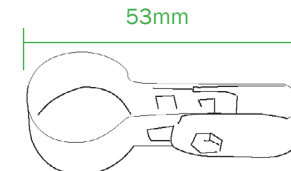

SINGLE SIDED CLIP - 81-5

This component is used to attach the wire mesh to the Primary Tubing. All clips are supplied with a M6 x 35mm nut and bolt.

Material : Galvanised steel to BS EN ISO 1461. Net weight : 0.07 kg.

Kee Cover Components

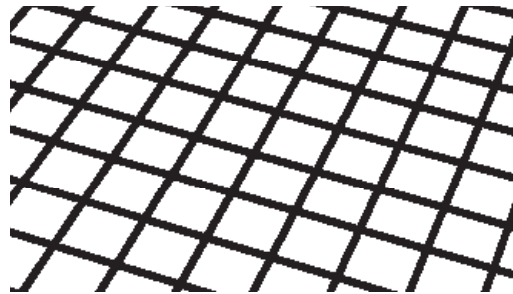
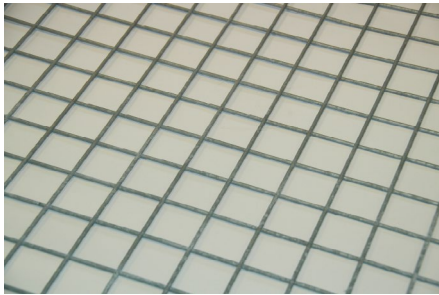

MESH PANEL - WMP8023

This component lays on top of the Tube Frame and is attached on all sides to the tubing via the Single Sided Clips. 1000 x 2000mm Mesh panel, 50mm x 50mm x 3.2mm.
Material : Galvanised steel to BS EN ISO 1461. Net weight : 6kg.

MESH PANEL - WMP4023

This component lays on top of the Tube Frame and is attached on all sides to the tubing via the Single Sided Clips. 1000 x 1000mm Mesh panel 50mm x 50mm x 3.2mm.
Material : Galvanised steel to BS EN ISO 1461. Net weight : 3kg.

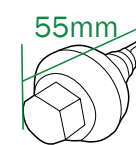

SELF DRILLING SCREW - SDS55X55G

Self drilling screw with neoprene washer. 5.5 x 55mm.
Material : BZP Steel. Net weight : 0.006kg.



SEALING STRIP - TA-SEAL

15m roll of sealing strip.
Material : BZP Steel. Net weight : 1kg.

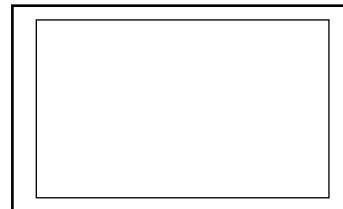

IDENTIFICATION PLAQUE - KCIDPLA01

To identify product during inspection with holes to allow. 17mm x 10mm. Thickness 3mm.
Material : PVC Foamex Board. Net weight : 0.03kg.

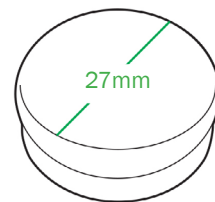

PLASTIC PLUG - 77-5

This component is fitted to the top of the Horizontal Standard Tubing.
Material : PVC. Net weight : 0.009kg.

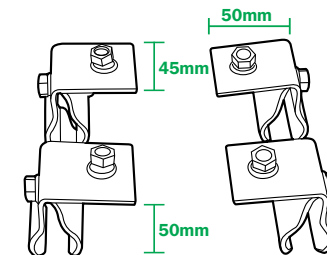
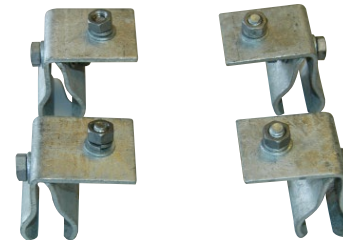

STANDING SEAM CLAMPS - KCFP1

These are used in conjunction with the 62-5 or 70-5 fittings to connect the Kee Cover to the roof structure. Material : Galvanised steel to BS EN ISO 1461 Net weight : 1kg.

Exploded Diagram

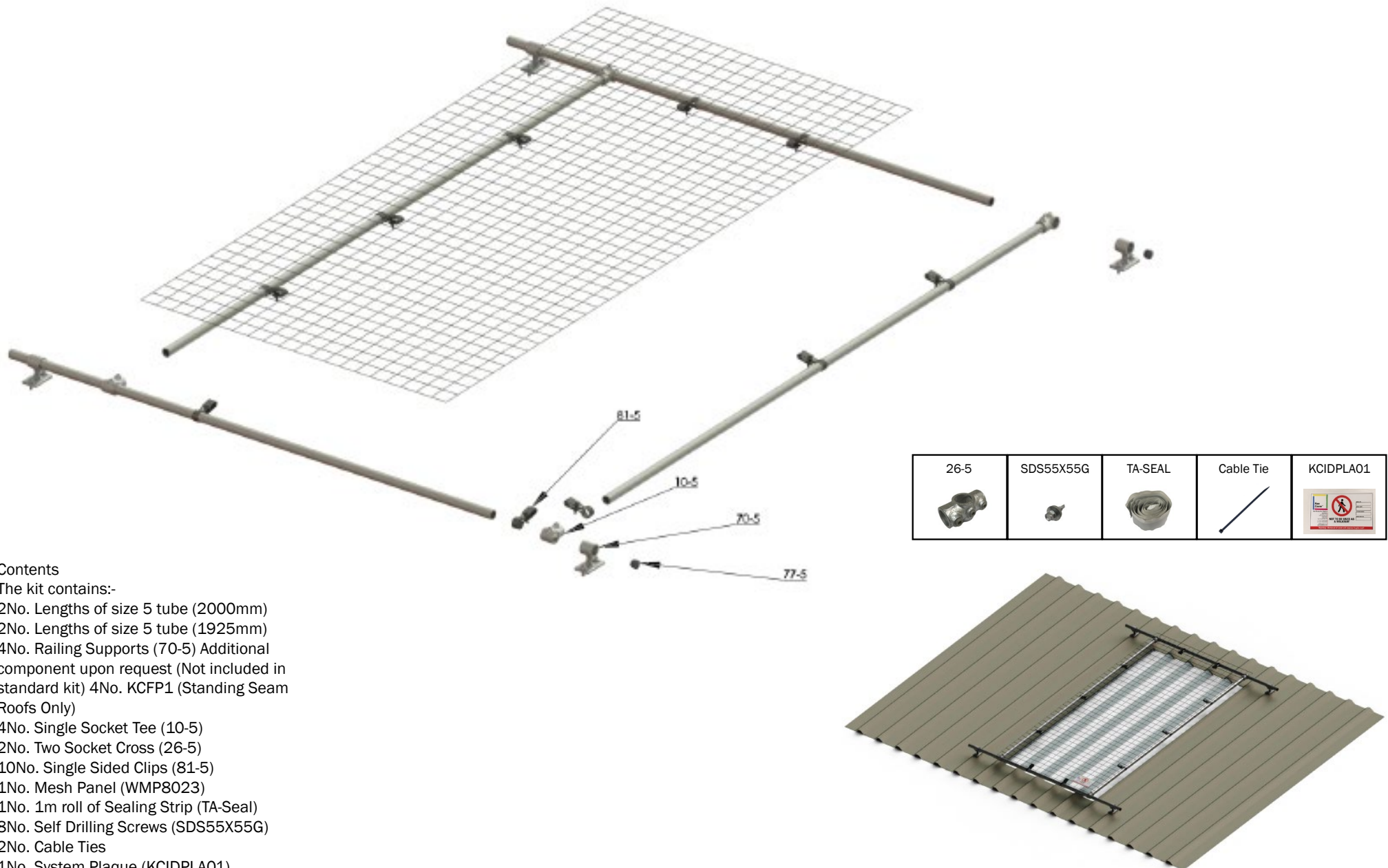

Contents

The kit contains:-

- 2No. Lengths of size 5 tube (2000mm)
- 2No. Lengths of size 5 tube (1925mm)
- 4No. Railing Supports (70-5) Additional component upon request (Not included in standard kit)
- 4No. KCFP1 (Standing Seam Roofs Only)
- 4No. Single Socket Tee (10-5)
- 2No. Two Socket Cross (26-5)
- 10No. Single Sided Clips (81-5)
- 1No. Mesh Panel (WMP8023)
- 1No. 1m roll of Sealing Strip (TA-Seal)
- 8No. Self Drilling Screws (SDS55X55G)
- 2No. Cable Ties
- 1No. System Plaque (KCIDPLA01)



TOOLS REQUIRED

You will need the following in order to install the Kee Cover®:

- Marker Pen
- Tape Measure
- 2No. 10mm Ring Spanners
- 1/4" Allen Key
- Torque Wrench 10- 60 Nm approx
- Small Magnetic Level

Assembly and Mounting of Kee Cover®

Please use adequate fall protection equipment when installing Kee Cover®. Failure to do so could result in Death or serious injury!

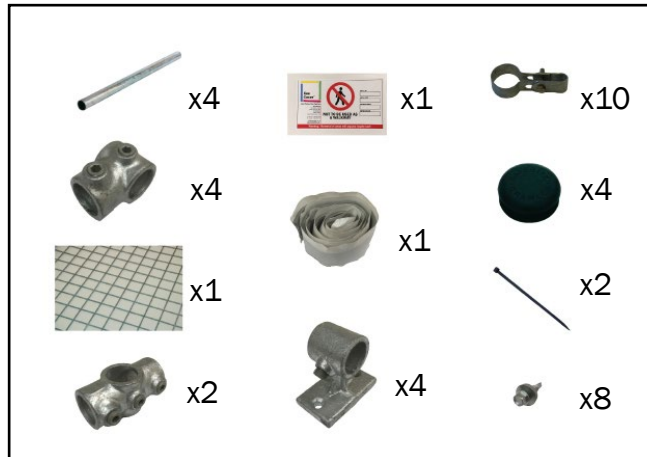

A. Carefully open packaging and check all the kit listed on previous page has been delivered.

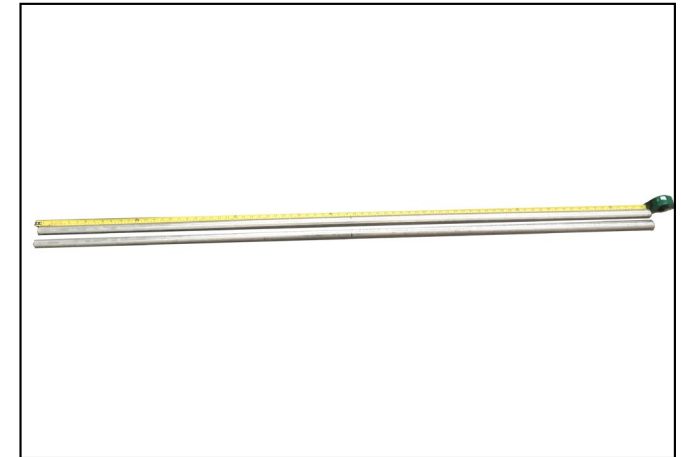

B. Select the 2No. lengths of size 5 tube (2000mm) and measure & mark the centre point of each of the tubes.



C. Carefully measure 455mm from each side of the centre point and mark. Slide a (10-5) Single Socket Tee to align with each of the four marked positions, rotate fitting to ensure correct orientation (see stage E) and tighten the grub screws using a 1/4" Allen Key. NB If further extension panels are to be used then replace 2no. (10-5) Single Socket Tee for 2No. (26-5) Two Socket Cross fittings as this will permit further panels to be linked.

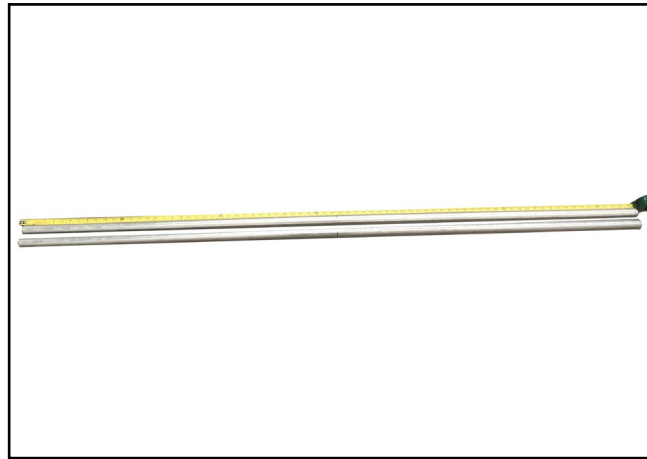

D. Select the 2No. 1925mm lengths of tube and insert each of the tubes into the (10-5) Single Socket Tee mounted on the 2No. lengths of size 5 tube (2000mm) and tighten the grub screws using a 1/4" Allen Key. This will now form a large rectangle (Frame).

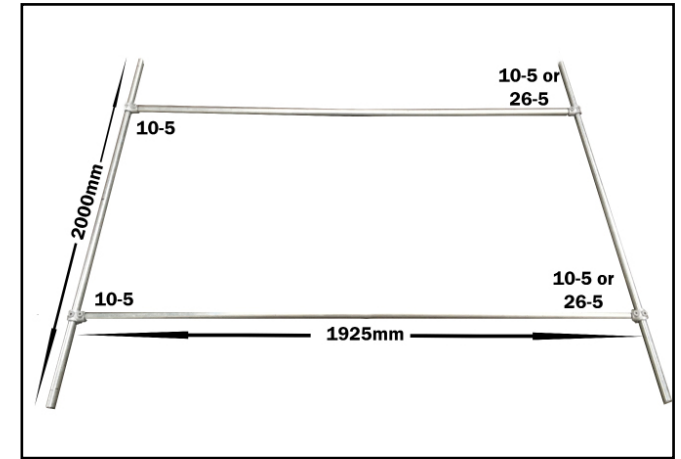

E. See diagram above to ensure frame is formed correctly.

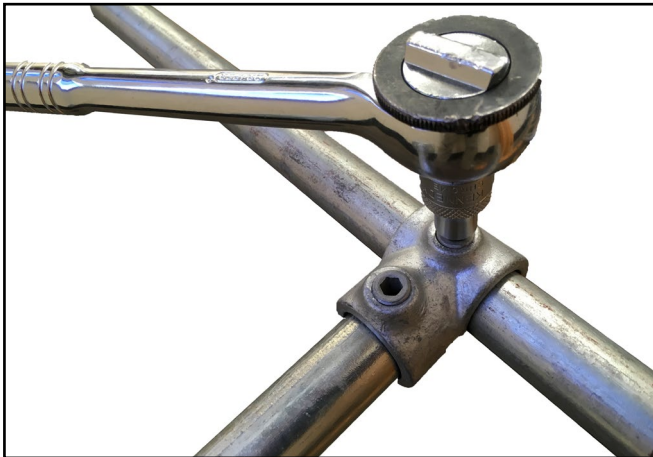

F. Using a 1/4" Allen Key ensure all grub screws are finally tightened.

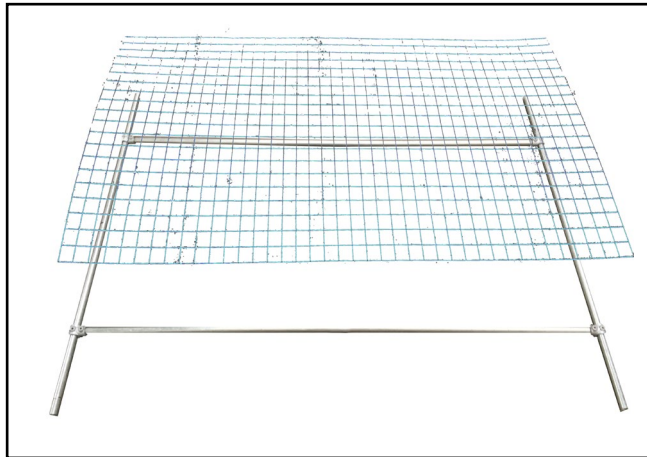

G. Carefully overlay mesh panel onto the frame. The mesh panel will be slightly larger than the frame itself.

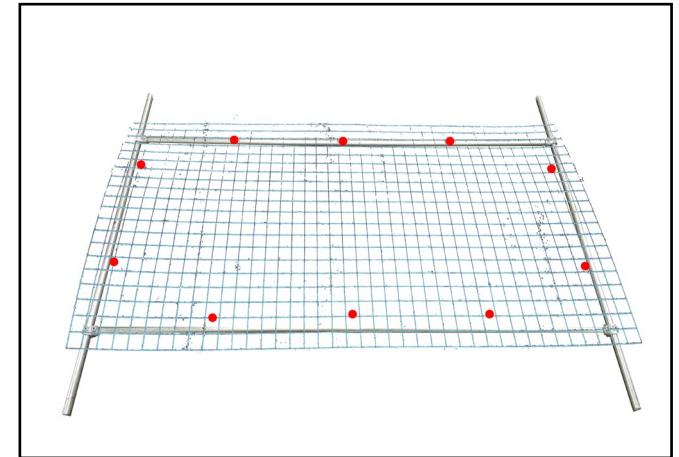

H. To connect the Mesh Panel and Frame together with the 10No. (81-5) Single Sided Clips position the Single Sided Clips as per diagram above.



I. Mesh panels clips are to be attached as above diagram.

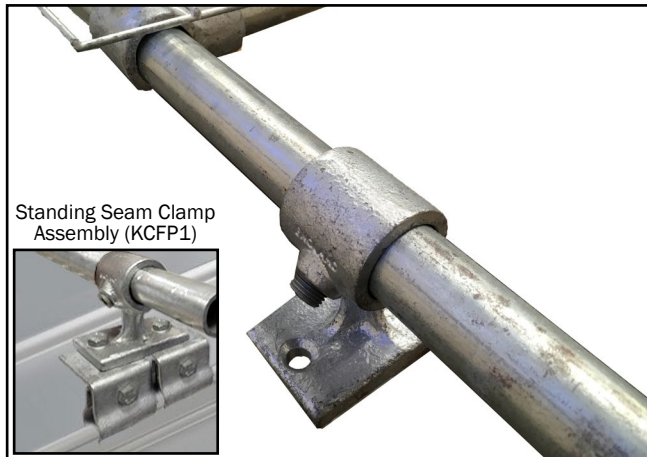

J. Slide 1No. Rail Support fitting over each end of the exposed tube in the corners of the frame. Carefully align the fitting to ensure it is positioned on the crown of roof sheet. NB If attaching to standing seam roof use KCFP1 clamps to connect to the standing seam and bolt the 70-5 fitting to the KCFP1 clamp as shown in the diagram and proceed to step **L**.



K. Carefully cut 4No. 80mm lengths of sealing strip. Place the Sealing Strip between the 4No. Rail Support fittings and the roof structure. Use Self Drilling Screws (SDS55X55G) to attach the screen onto the roofing sheet.

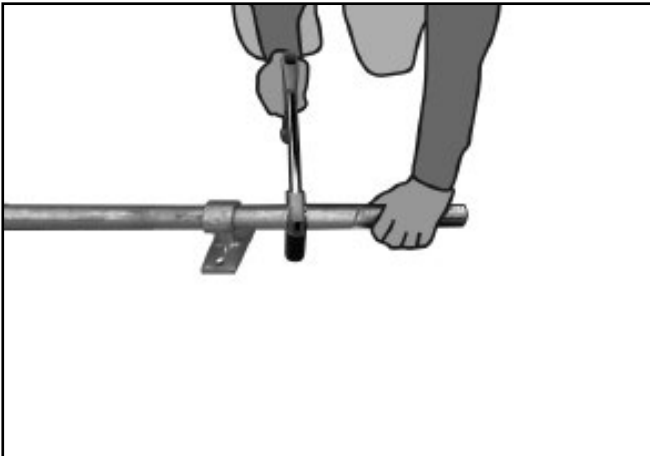

L. To avoid the risk of trip hazards from exposed tubing use a hacksaw or similar carefully cut through the excess lengths of tubes as shown, leaving approximately 50mm of tube exposed. For galvanised assemblies, spray with Galvafoid or similar to prevent corrosion.

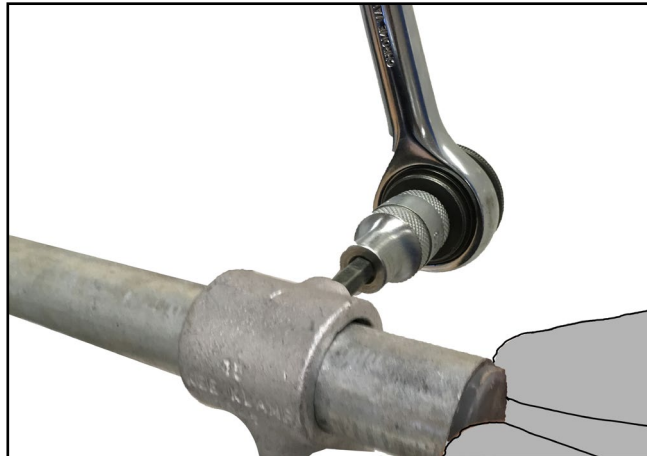

M. Using a 1/4" Allen key/torque wrench ensure all fittings are torqued to 39Nm. Place plastic end caps on exposed ends of tubes to ensure minimal water ingress.

Caution! Ensure all fittings are sufficiently torqued to 39Nm and panel is securely held onto roofing structure.



N. Place identification plaque on screen and complete details, Secure plaque using supplied cable ties.



Note:- Installing Kee Cover®:- Working at height is dangerous and skylights may not be suitable to bear any weight. When installing Kee Cover® always use appropriate fall protection equipment!

Exploded Diagram

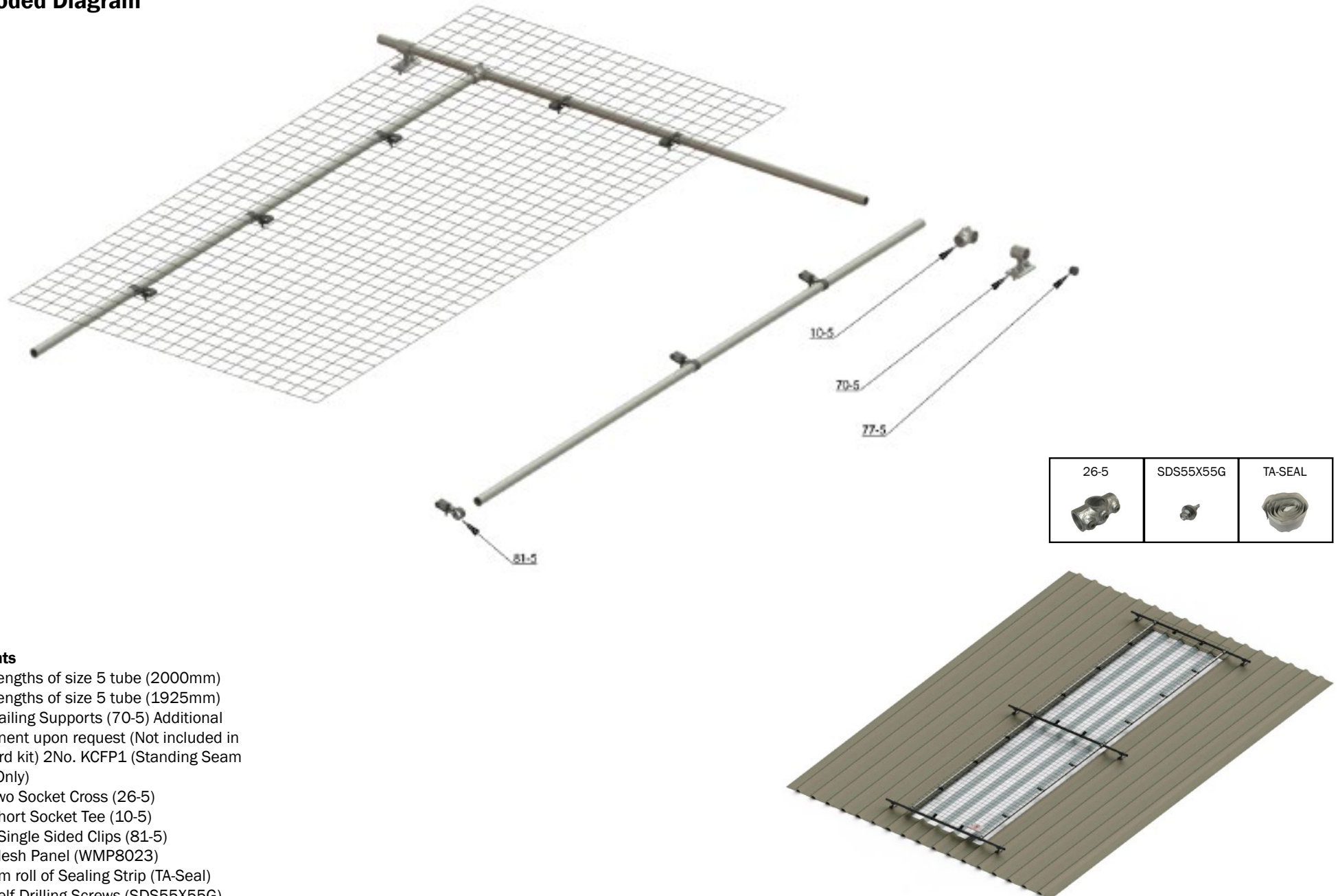

Contents

- 1No. Lengths of size 5 tube (2000mm)
- 2No. Lengths of size 5 tube (1925mm)
- 2No. Railing Supports (70-5) Additional component upon request (Not included in standard kit)
- 2No. KCFP1 (Standing Seam Roofs Only)
- 2No. Two Socket Cross (26-5)
- 2No. Short Socket Tee (10-5)
- 10No. Single Sided Clips (81-5)
- 1No. Mesh Panel (WMP8023)
- 1No. 1m roll of Sealing Strip (TA-Seal)
- 4No. Self Drilling Screws (SDS55X55G)



TOOLS REQUIRED

You will need the following in order to install the Kee Cover®:

- Marker Pen
- Tape Measure
- 2No. 10mm Ring Spanners
- 1/4" Allen Key
- Torque Wrench 10- 60 Nm approx
- Small Magnetic Level

Assembly and Mounting of Kee Cover®.

Please use adequate fall protection equipment when installing Kee Cover®. Failure to do so could result in Death or serious injury!

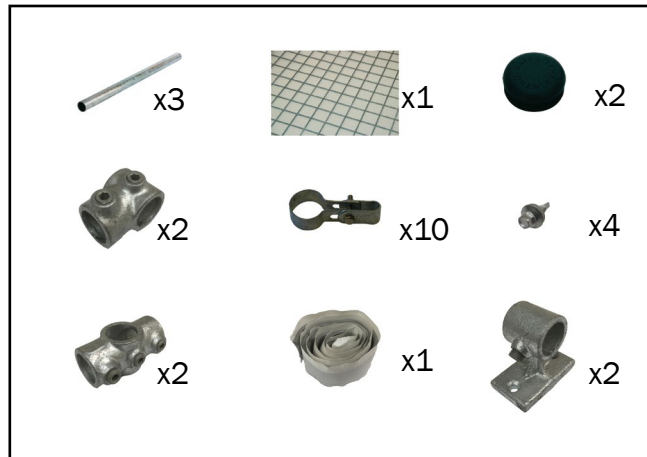

A. Carefully open packaging and check all the kit listed on previous page has been delivered.

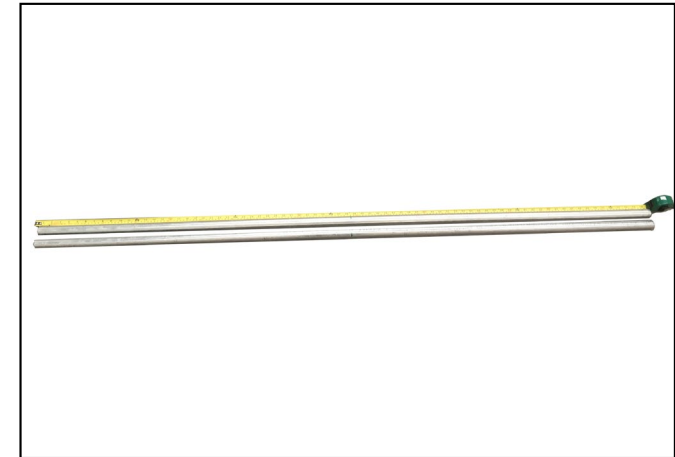

B. Select the 1No. length of size 5 tube (2000mm) and measure & mark the centre point of the tube.



C. Carefully measure 455mm from each side of the centre point and mark. Slide a (10-5) Single Socket Tee to align with each of the four marked position, rotate fitting to ensure correct orientation (see stage E) and tighten the grub screws using a 1/4" Allen Key. NB If further extension panels are to be used then replace 2no. (10-5) Single Socket Tee for 2No. (26-5) Two Socket Cross fittings as this will permit further panels to be linked.

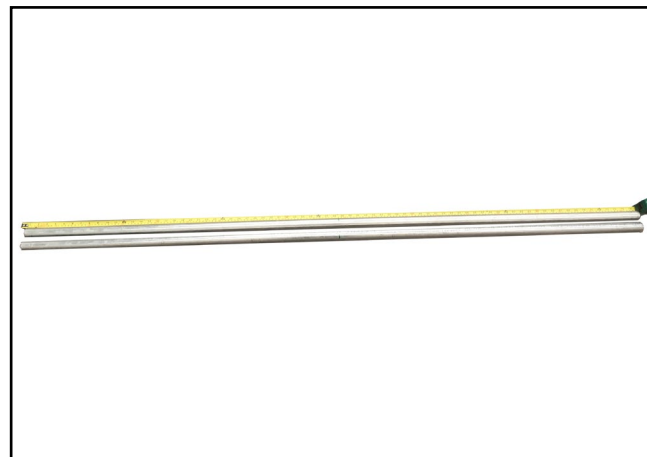

D. Select the 2No. 1925mm lengths of tube and insert the tubes into the (10-5) fittings mounted on the 1No. 2000mm length of size 5 tube. Tighten the grub screws using a 1/4" Allen Key. This will now form a large U Extension (frame).

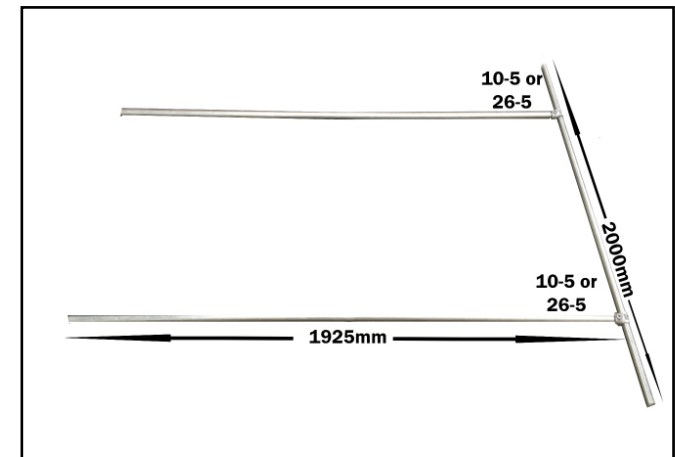

E. See diagram above to ensure frame is formed correctly.

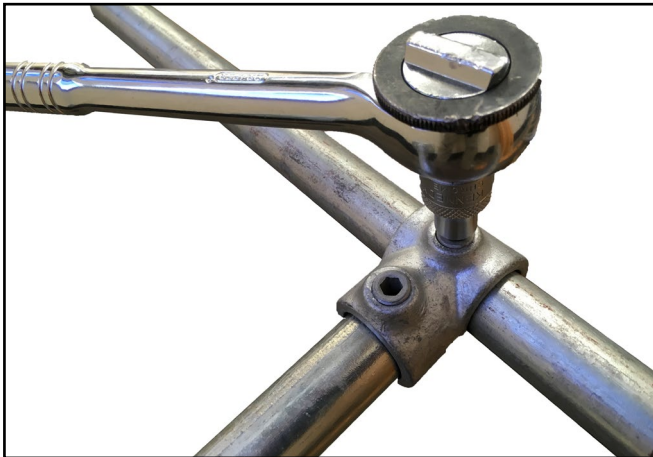

F. Using a 1/4" Allen Key ensure all grub screws are finally tightened.

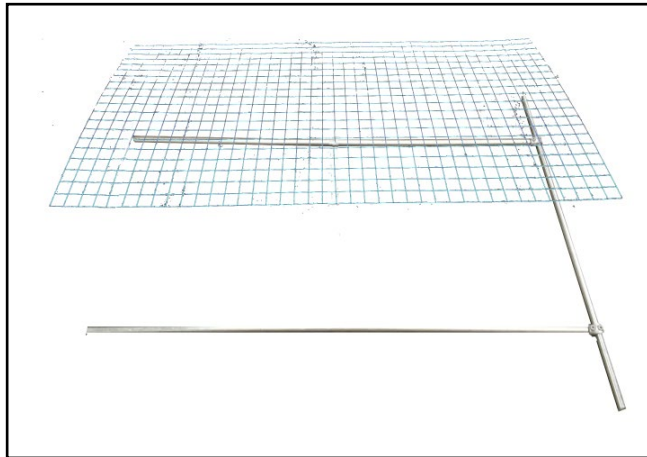

G. Carefully overlay mesh panel onto the frame. The mesh panel will be slightly larger than the frame itself.

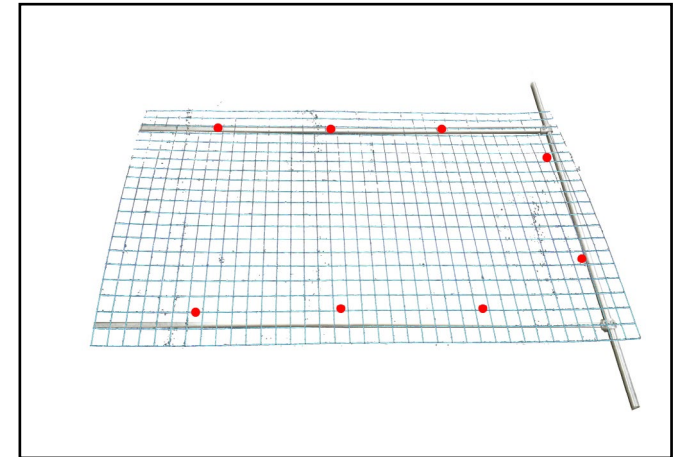

H. To connect the Mesh Panel and Frame together with 8 No (81-5) Single Sided Clips position the Single Sided Clips as per diagram above.



I. Mesh panel clips are to be attached as above diagram

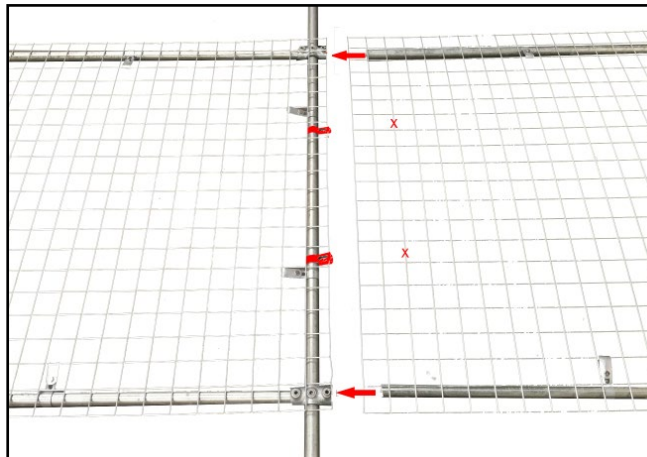

J. Insert extension panel tube ends into 26-5 of primary screen, slight lifting of the mesh may be required as there will be a slight overlap. Tighten grub screws. Secure extension mesh to primary panel by attaching 2no. mesh panel clips (shown in red) onto existing screen, then secure mesh to extension panel where red 'X' is shown.

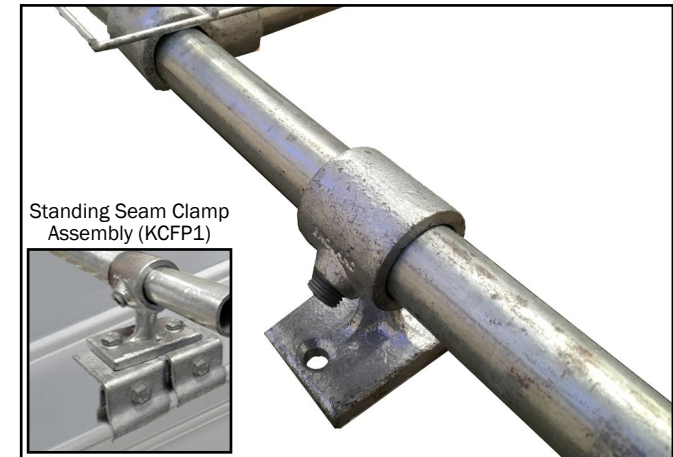

K. Slide 1No. Rail Support fitting over each end of the exposed tube in the corners of the frame. Carefully align the fitting to ensure it is positioned on the crown of roof sheet. NB If attaching to standing seam roof use KCFP1 clamps to connect to the standing seam and bolt the 70-5 fitting to the KCFP1 clamp as shown in the diagram and proceed to step **M**.



L. Carefully cut 2No. 80mm lengths of sealing strip. Place the Sealing Strip between the 2No. Rail Support fittings and the roof structure. Use Self Drilling Screws (SDS55X55G) to attach the screen onto the roofing sheet.

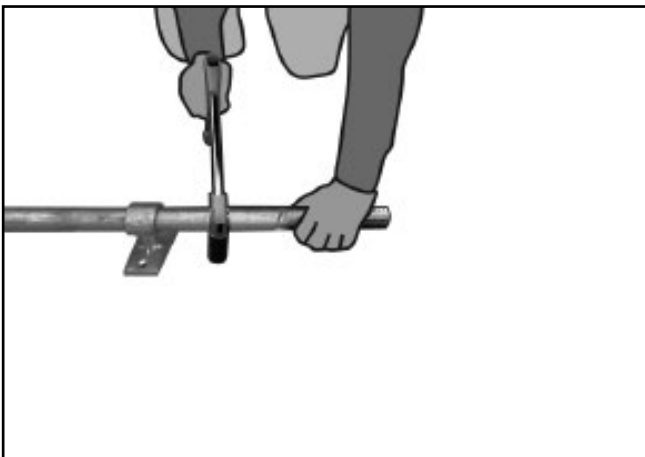

M. To avoid the risk of trip hazards from exposed tubing use a hacksaw or similar carefully cut through the excess lengths of tubes as shown, leaving approximately 50mm of tube exposed. For galvanised assemblies, spray with Galvafoid or similar to prevent corrosion.

Caution! Ensure all fittings are sufficiently torqued to 39Nm and panel is securely held onto roofing structure.

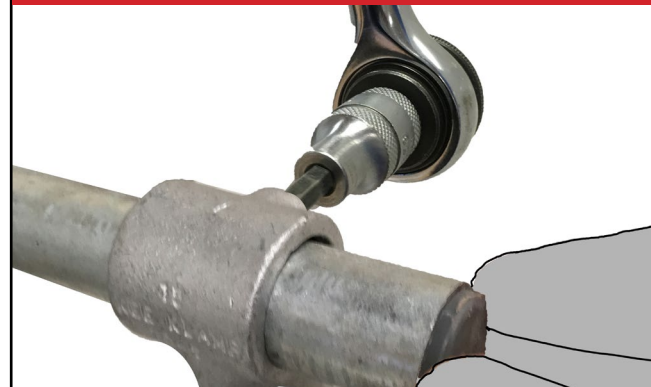

N. Using a 1/4" Allen key/torque wrench ensure all fittings are torqued to 39Nm. Place plastic end caps on exposed ends of tubes to ensure minimal water ingress.



Note:- Installing Kee Cover®:- Working at height is dangerous and skylights may not be suitable to bear any weight. When installing Kee Cover® always use appropriate fall protection equipment!

Exploded Diagram

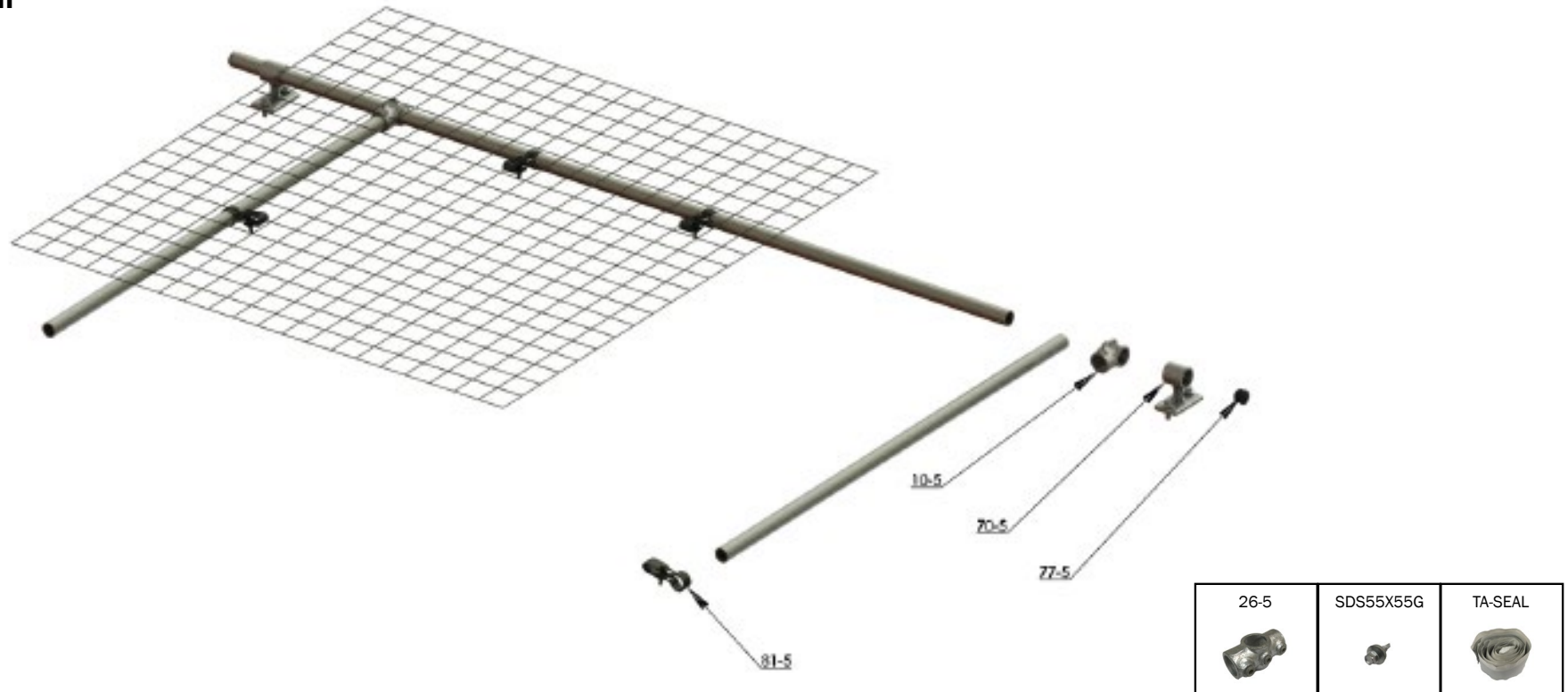

Contents

- 1No. Lengths of size 5 tube (2000mm)
- 2No. Lengths of size 5 tube (925mm)
- 2No. Railing Supports (70-5) Additional component upon request (Not included in standard kit) 2No. KCFP1 (Standing Seam Roofs Only)
- 2No. Two Socket Cross (26-5)
- 2No. Short Socket Tee (10-5)
- 8No. Single Sided Clips (81-5)
- 1No. Mesh Panel (WMP4023)
- 1No. 1m roll of Sealing Strip (TA-Seal)
- 4No. Self Drilling Screws (SDS55X55G)





TOOLS REQUIRED

You will need the following in order to install the Kee Cover®:

- Marker Pen
- Tape Measure
- 2No. 10mm Ring Spanners
- 1/4" Allen Key
- Torque Wrench 10- 60 Nm approx
- Small Magnetic Level

Assembly and Mounting of Kee Cover®.

Please use adequate fall protection equipment when installing Kee Cover®. Failure to do so could result in Death or serious injury!

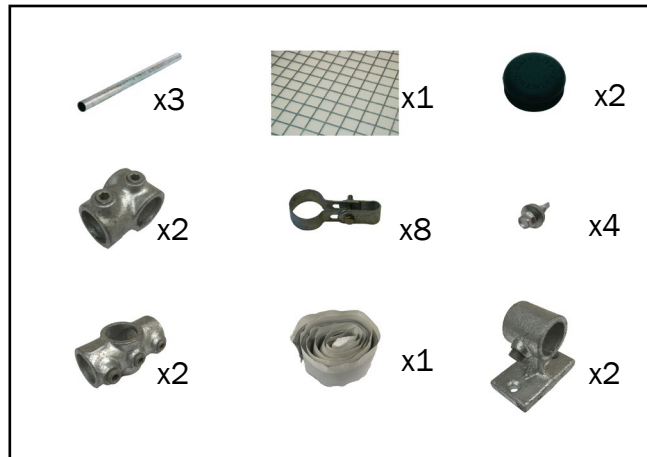

A. Carefully open packaging and check all the kit listed on previous page has been delivered.

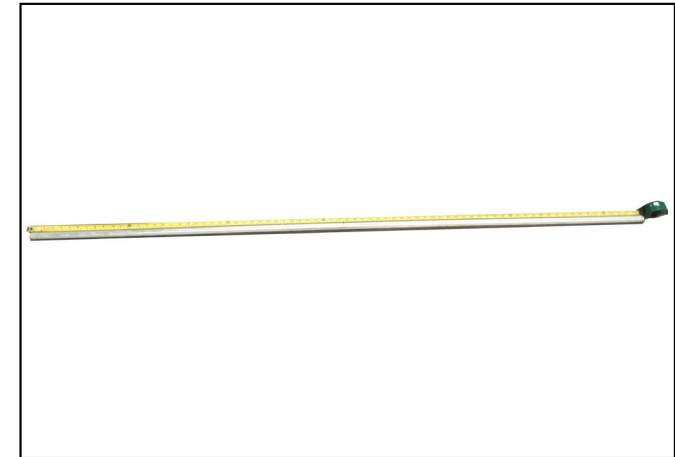

B. Select the 1No. length of size 5 tube (2000mm) and measure & mark the centre point of the tube.



C. Carefully measure 455mm from each side of the centre point and mark. Slide a (10-5) Single Socket Tee to align with each of the four marked position, rotate fitting to ensure correct orientation (see stage E) and tighten the grub screws using a 1/4" Allen Key. NB If further extension panels are to be used then replace 2no. (10-5) Single Socket Tee for 2No. (26-5) Two Socket Cross fittings as this will permit further panels to be linked.

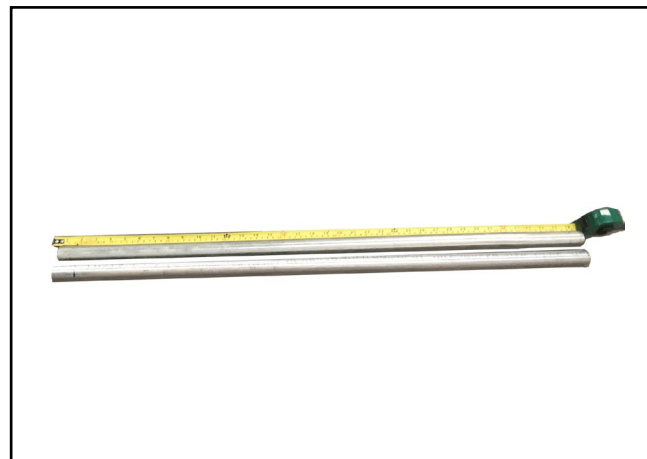

D. Select the 2No. 925mm lengths of tube and insert the tubes into the (10-5) fittings mounted on the 1No. 2000mm length of size 5 tube. Tighten the grub screws using a 1/4" Allen Key. This will now form a large U Extension (frame).

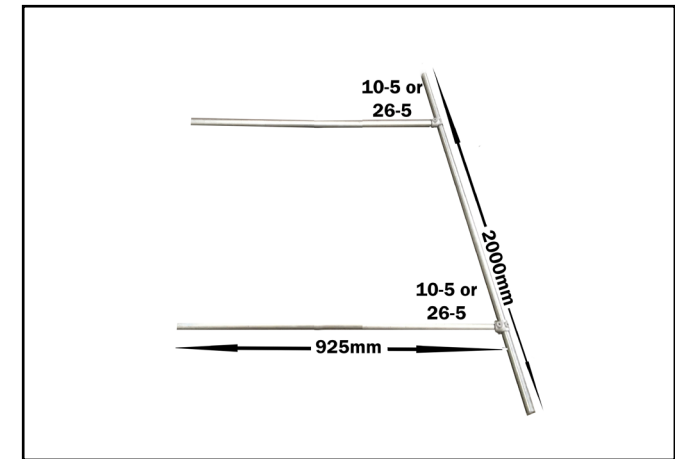

E. See diagram above to ensure frame is formed correctly.

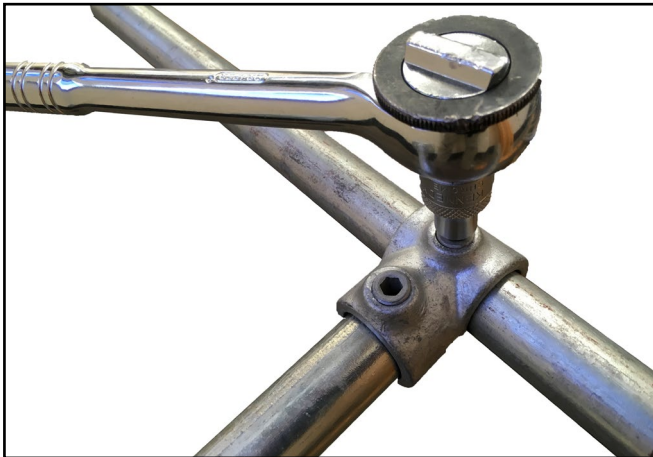

F. Using a 1/4" Allen Key ensure all grub screws are finally tightened.

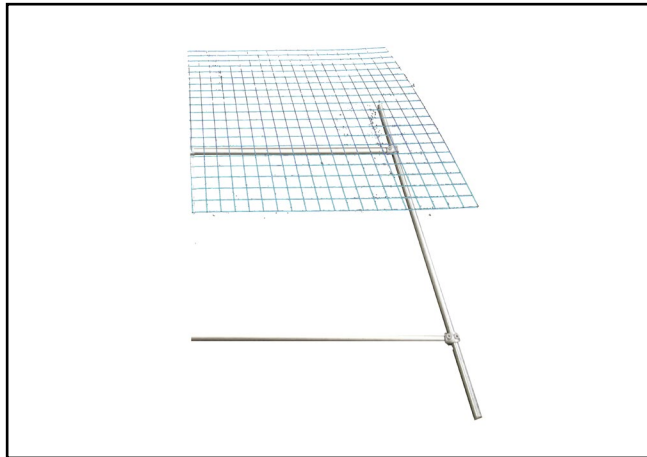

G. Carefully overlay mesh panel onto the frame. The mesh panel will be slightly larger than the frame itself.

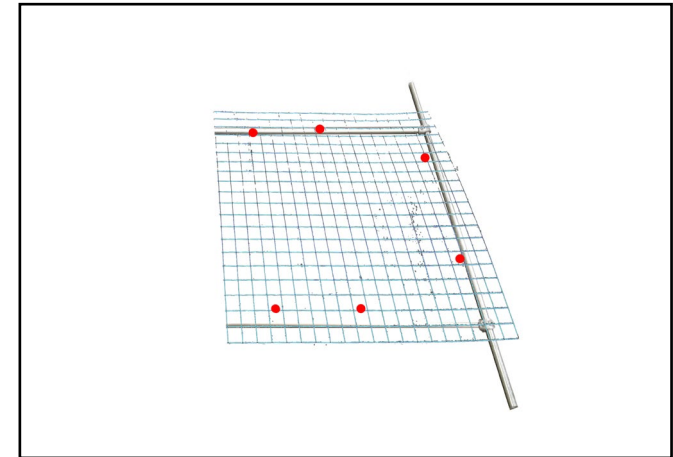

H. To connect the Mesh Panel and Frame together with the 6No. (81-5) Single Sided Clips position the Single Sided Clips as per diagram above.



I. Mesh panel clips are to be attached as above diagram

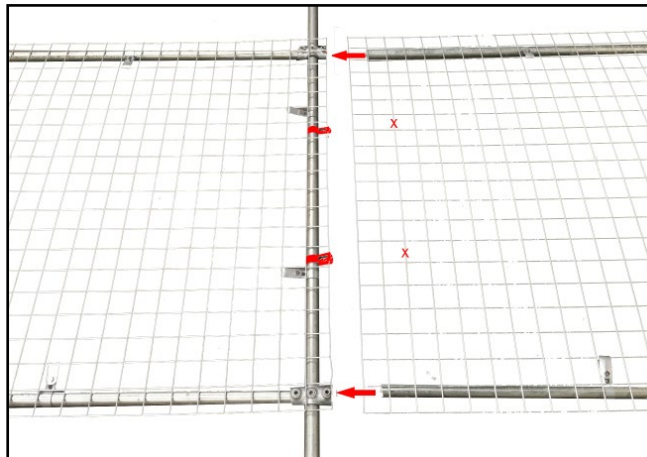

J. Insert extension panel tube ends into 26-5 of primary screen, slight lifting of the mesh may be required as there will be a slight overlap. Tighten grub screws. Secure extension mesh to primary panel by attaching 2no. mesh panel clips (shown in red) onto existing screen, then secure mesh to extension panel where red 'X' is shown.

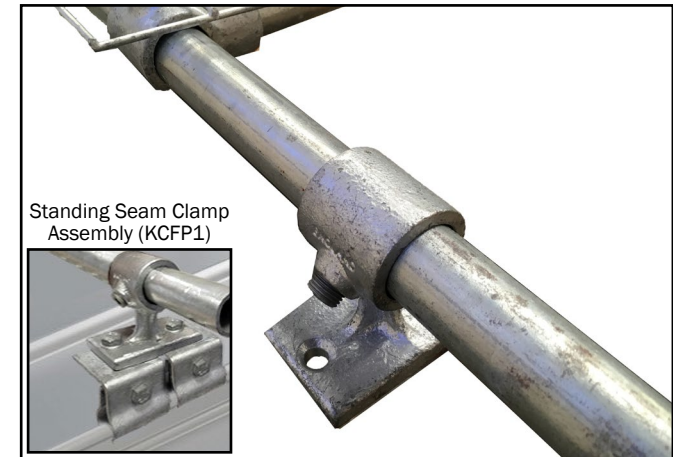

K. Slide 1No. Rail Support fitting over each end of the exposed tube in the corners of the frame. Carefully align the fitting to ensure it is positioned on the crown of roof sheet. NB If attaching to standing seam roof use KCFP1 clamps to connect to the standing seam and bolt the 70-5 fitting to the KCFP1 clamp as shown in the diagram and proceed to step **M**.



L. Carefully cut 2No. 80mm lengths of sealing strip. Place the Sealing Strip between the 2No. Rail Support fittings and the roof structure. Use Self Drilling Screws (SDS55X55G) to attach the screen onto the roofing sheet.

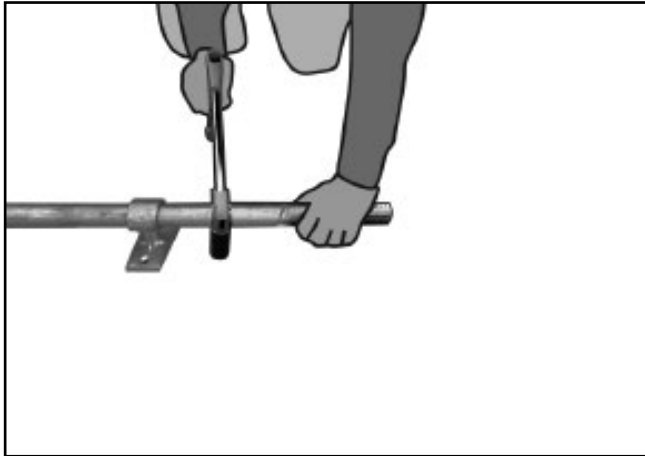

M. To avoid the risk of trip hazards from exposed tubing use a hacksaw or similar carefully cut through the excess lengths of tubes as shown, leaving approximately 50mm of tube exposed. For galvanised assemblies, spray with Galvafoid or similar to prevent corrosion.

Caution! Ensure all fittings are sufficiently torqued to 39Nm and panel is securely held onto roofing structure.

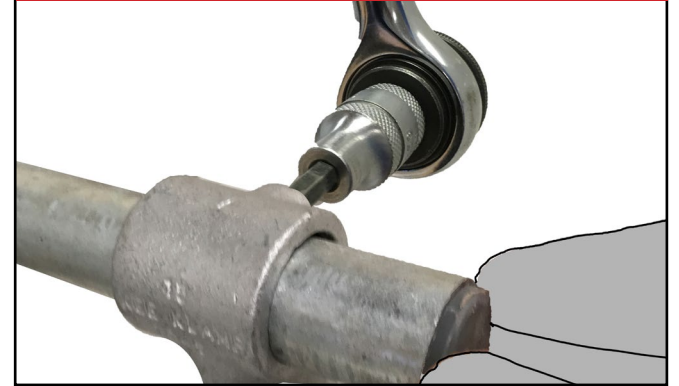

N. Using a 1/4" Allen key/torque wrench ensure all fittings are torqued to 39Nm. Place plastic end caps on exposed ends of tubes to ensure minimal water ingress.



Note:- Installing Kee Cover®:- Working at height is dangerous and skylights may not be suitable to bear any weight. When installing Kee Cover® always use appropriate fall protection equipment!



Exploded Diagram

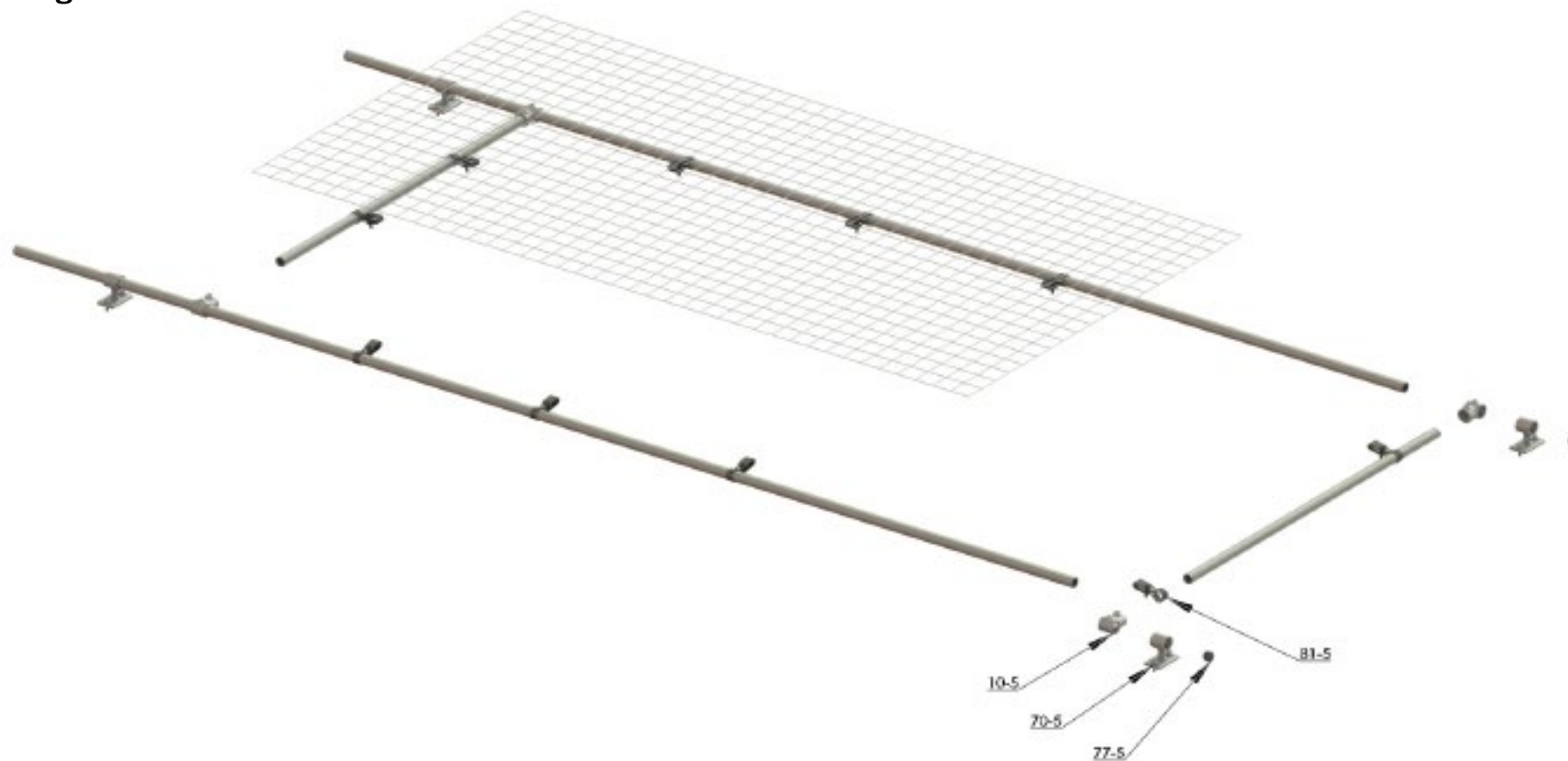

Contents

- 2No. Lengths of size 5 tube (3000mm)
- 2No. Lengths of size 5 tube (925mm)
- 4No. Railing Supports (70-5) Additional component upon request (Not included in standard kit)
- 4No KCFP1 (Standing Seam Roofs Only)
- 4No. Single Socket Tee (10-5)
- 2No. Two Socket Cross (26-5)
- 10No. Single Sided Clips (81-5)
- 1No. Mesh Panel (WMP8023)
- 1No. 1m roll of Sealing Strip (TA-Seal)
- 8No. Self Drilling Screws (SDS55X55G)
- 2No. Cable Ties
- 1No. System Plaque (KCIDPLA01)

<p>26-5</p> 	<p>SDS55X55G</p> 	<p>TA-SEAL</p> 	<p>Cable Tie</p> 	<p>KCIDPLA01</p> 
---	--	--	--	--





TOOLS REQUIRED

You will need the following in order to install the Kee Cover®:

- Marker Pen
- Tape Measure
- 2No. 10mm Ring Spanners
- 1/4" Allen Key
- Torque Wrench 10- 60 Nm approx
- Small Magnetic Level

Assembly and Mounting of Kee Cover®.

Please use adequate fall protection equipment when installing Kee Cover®. Failure to do so could result in Death or serious injury!

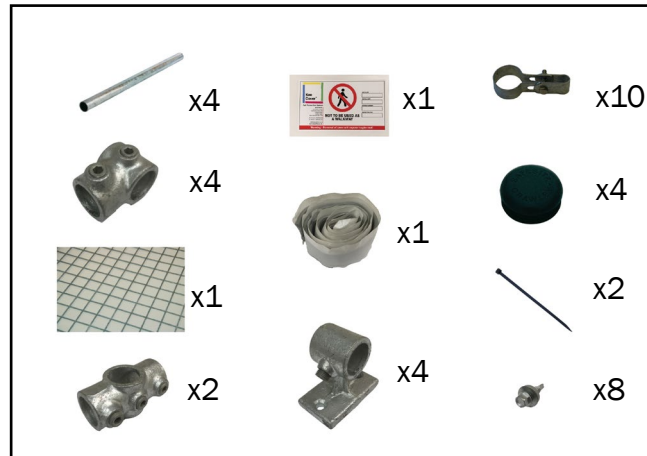

A. Carefully open packaging and check all the kit listed on previous page has been delivered.

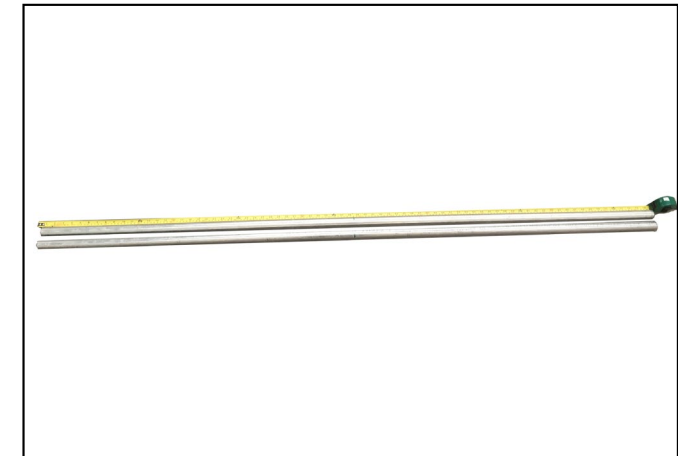

B. Select the 2No. 3000mm lengths of size 5 tube and measure & mark the centre point of each of the tubes.



C. Measure 995mm from the centre point of each of the 3000mm tubes and slide a (10-5) Single Socket Tee into each of the four marked position and tighten the grub screws using a 3/16" Allen Key. NB If further extension panels are to be used then replace 2no. (10-5) Single Socket Tee for 2No. (26-5) Two Socket Cross fittings this will permit further panels to be connected to the primary.

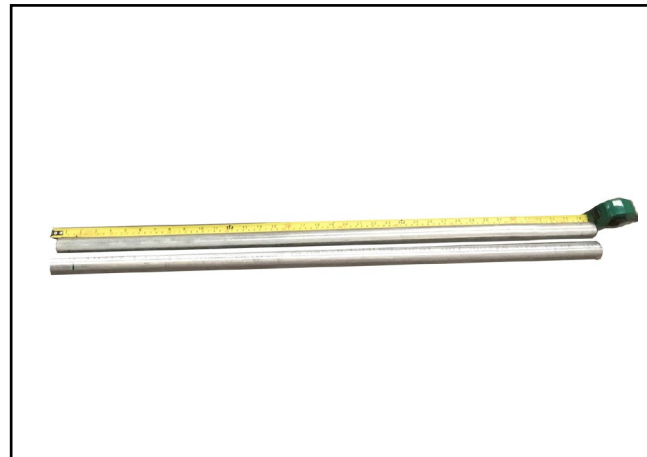

D. Select the 2No 925mm lengths of tube and insert each of the tubes into the (10-5) Single Socket Tee mounted on the 2No. 3000mm lengths of size 5 tube and tighten the grub screws using a 1/4" Allen Key. This will now form a large rectangular frame.

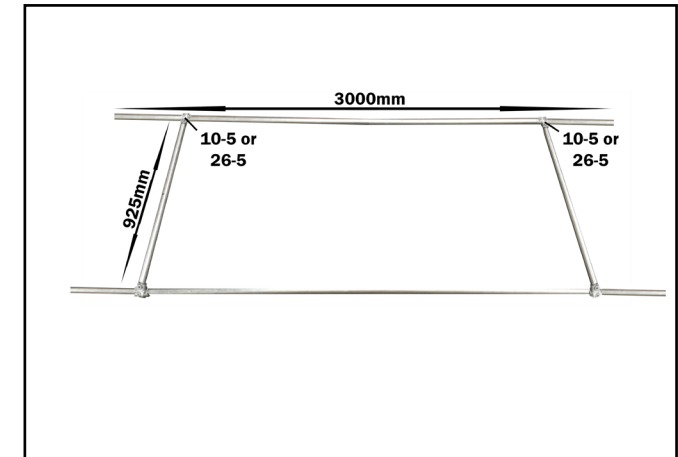

E. See diagram above to ensure frame formed correctly.



F. Using a 1/4" Allen Key ensure all grub screws are finally tightened.

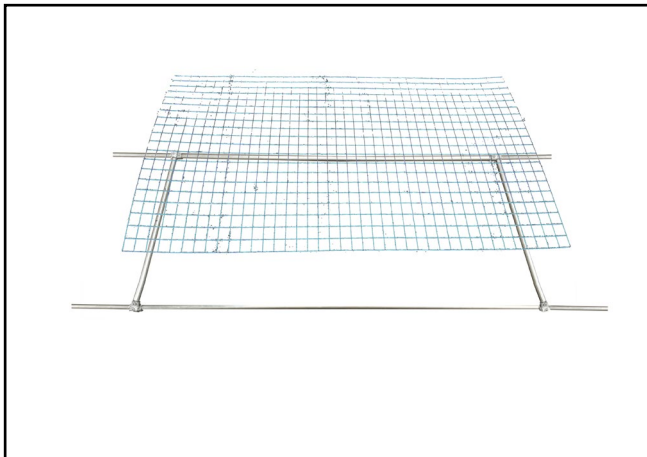

G. Carefully overlay mesh panel onto the frame. The mesh panel will be slightly larger than the frame itself.

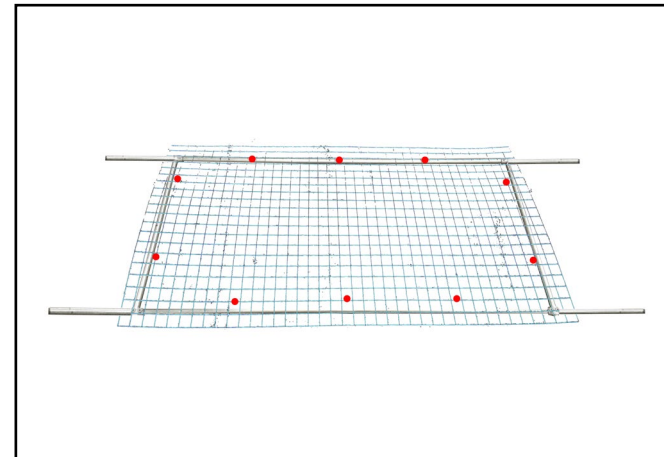

H. To connect the Mesh Panel and Frame together with the 10No. (81-5) Single Sided Clips. Position the Single Sided Clips as per diagram above.



I. Mesh panels clips are to be attached as above diagram.

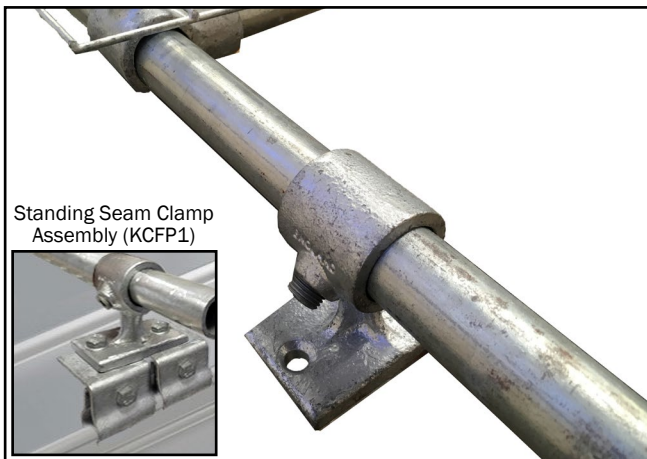

J. Slide 1No. Rail Support fitting over each end of the exposed tube in the corners of the frame. Carefully align the fitting to ensure it is positioned on the crown of roof sheet. NB If attaching to standing seam roof use KCFP1 clamps to connect to the standing seam and bolt the 70-5 fitting to the KCFP1 clamp as shown in the diagram and proceed to step L.



K. Carefully cut 4No. 80mm lengths of sealing strip. Place the Sealing Strip between the 4No Rail Support fittings and the roof structure. Use Self Drilling Screws (SDS55X55G) to attach the screen onto the roofing sheet.

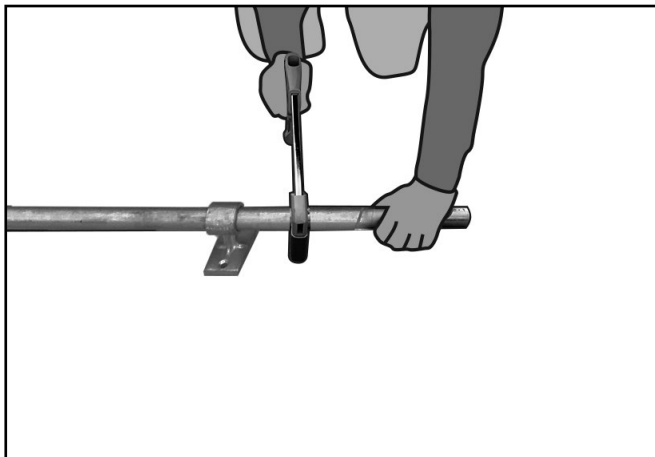

L. To avoid the risk of trip hazards from exposed tubing use a hacksaw or similar carefully cut through the excess lengths of tubes as shown, leaving approximately 50mm of tube exposed. For galvanised assemblies, spray with Galvafoid or similar to prevent corrosion.

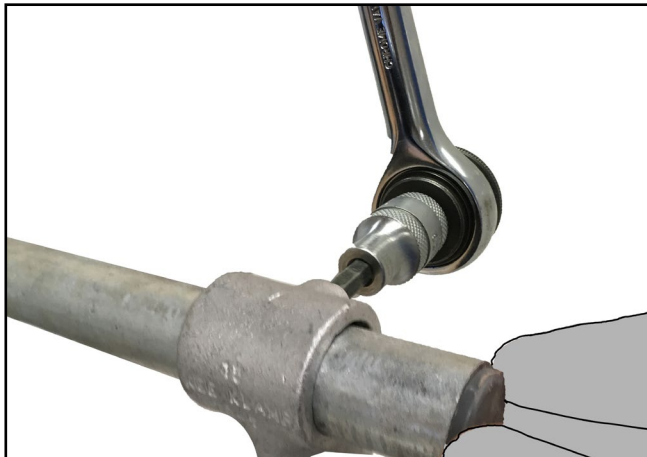

M. Using a 1/4" Allen key/torque wrench ensure all fittings are torqued to 39Nm. Place plastic end caps on exposed ends of tubes to ensure minimal water ingress

Caution! Ensure all fittings are sufficiently torqued to 39Nm and panel is securely held onto roofing structure.



N. Place identification plaque on screen and complete details, Secure plaque using supplied cable ties.



Note:- Installing Kee Cover®:- Working at height is dangerous and skylights may not be suitable to bear any weight. When installing Kee Cover® always use appropriate fall protection equipment!

Exploded Diagram



26-5	SDS55X55G	TA-SEAL

Contents

- 1No. Lengths of size 5 tube (3000mm)
- 2No. Lengths of size 5 tube (925mm)
- 2No. Railing Supports (70-5) Additional component upon request (Not included in standard kit) 2No. KCFP1 (Standing Seam Roofs Only)
- 2No. Single Socket Tee (10-5)
- 2No. Two Socket Cross (26-5)
- 10No. Single Sided Clips (81-5)
- 1No. Mesh Panel (WMP8023)
- 1No. 1m roll of Sealing Strip (TA-Seal)
- 4No. Tek Screws (SDS55X55G)





TOOLS REQUIRED

You will need the following in order to install the Kee Cover®:

- Marker Pen
- Tape Measure
- 2no. 10mm Ring Spanners
- 1/4" Allen Key
- Torque Wrench 10- 60 Nm approx
- Small Magnetic Level

Assembly and Mounting of Kee Cover®

Please use adequate fall protection equipment when installing Kee Cover®. Failure to do so could result in Death or serious injury!

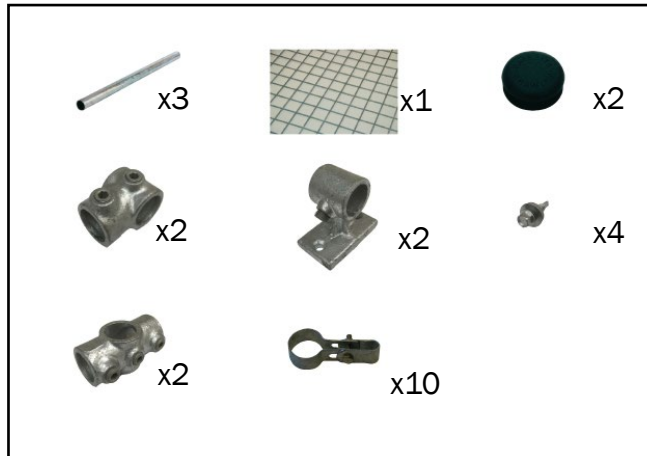

A. Carefully open packaging and check all the kit listed on previous page has been delivered.

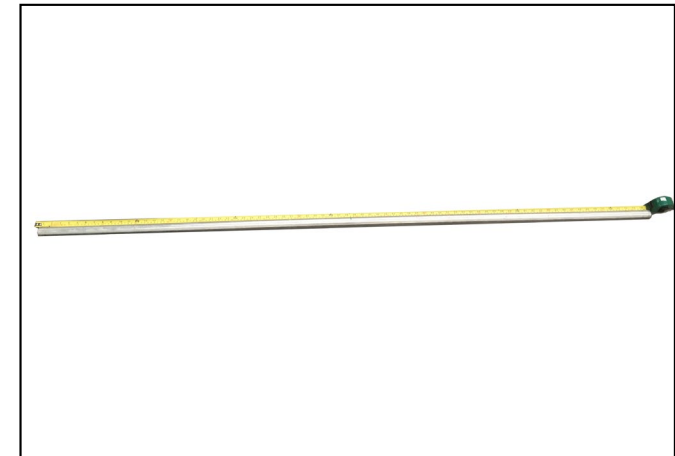

B. Select the 1No. 3000mm length of size 5 tube and measure & mark the centre point of each of the tubes.



C. Carefully measure 995mm from each side of the centre point mark. Slide 2No (10-5) Single Socket Tee to align with each of the two marked position, rotate fitting to ensure correct orientation (see stage E) and tighten the grub screws using a 1/4" Allen Key. NB If further extension panels are to be used then replace 2no. (10-5) Single Socket Tee for 2No. (26-5) Two Socket Cross fittings. This will permit further panels to be connected to the panel.

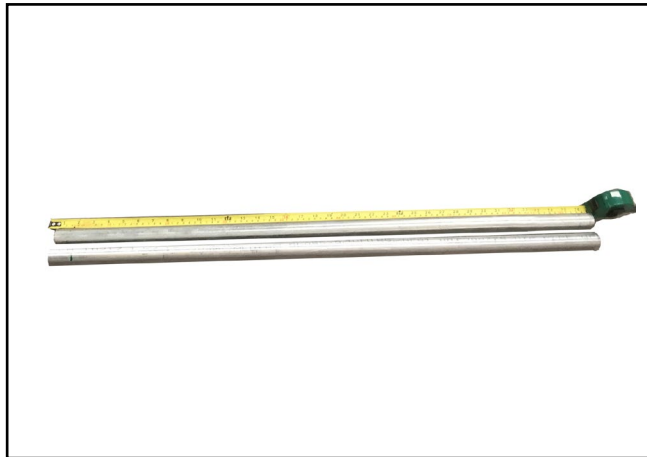

D. Select the 2No 925mm length of tube and insert the tube into the (10-5) fittings mounted on the 1No. 3000mm length of size 5 tube. Tighten the grub screws using a 1/4" Allen key. This will now form a large U Extension (frame).

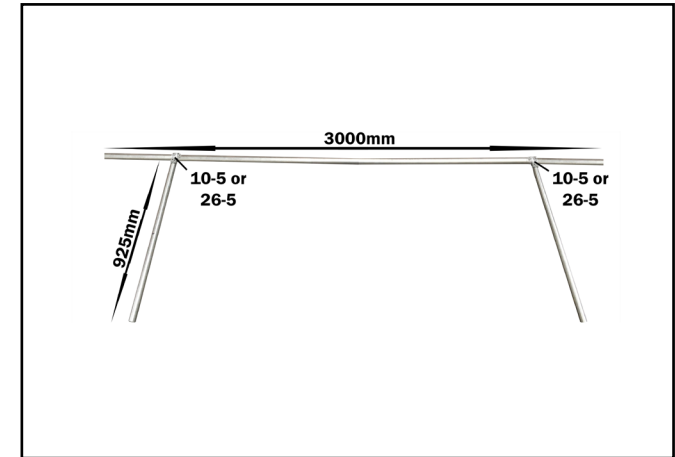

E. See diagram above to ensure frame is formed correctly.



F. Using a 1/4" Allen Key ensure all grub screws are finally tightened.

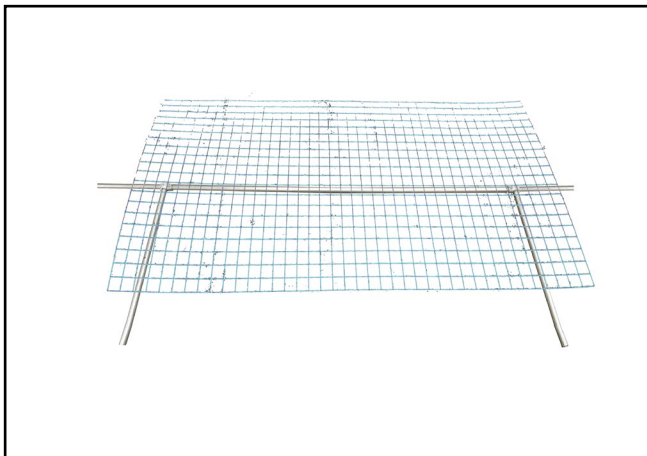

G. Carefully overlay mesh panel onto the frame. The mesh panel will be slightly larger than the frame itself.

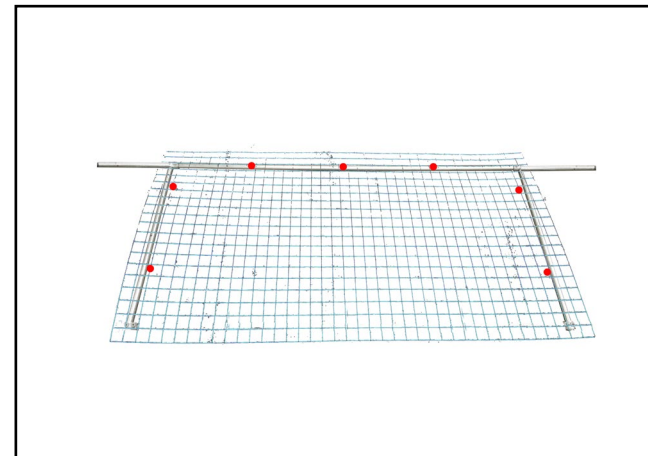

H. To connect the Mesh Panel and Frame together with the 10No (81-5) Single Sided Clips. Position the Single Sided Clips as per diagram above.



I. Mesh panel clips are to be attached as above diagram.

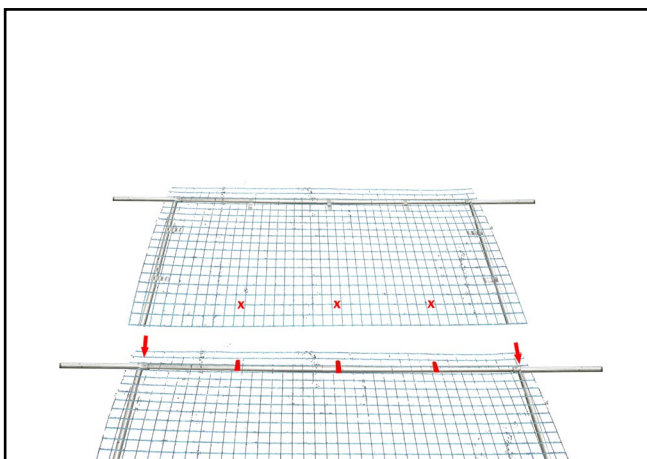

J. Insert extension panel tube ends into 26-5 of primary screen, slight lifting of the mesh may be required as there will be a slight overlap. Tighten grub screws. Secure extension mesh to primary panel by attaching 3no. mesh panel clips (shown in red) onto existing screen, then secure mesh to extension panel where red 'X' is shown.

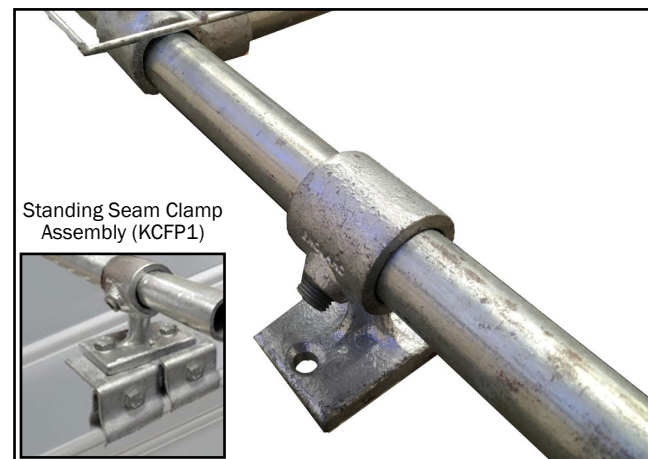

K. Slide 1No. Rail Support fitting over each end of the exposed tube in the corners of the frame. Carefully align the fitting to ensure it is positioned on the crown of roof sheet. NB If attaching to standing seam roof use KCFP1 clamps to connect to the standing seam and bolt the 70-5 fitting to the KCFP1 clamp as shown in the diagram and proceed to step **L**.



L. Carefully cut 4No. 80mm lengths of sealing strip. Place the Sealing Strip between the 4No Rail Support fittings and the roof structure. Use (SDS55X55G) Self Drilling Screws to attach the screen onto the roofing sheet.

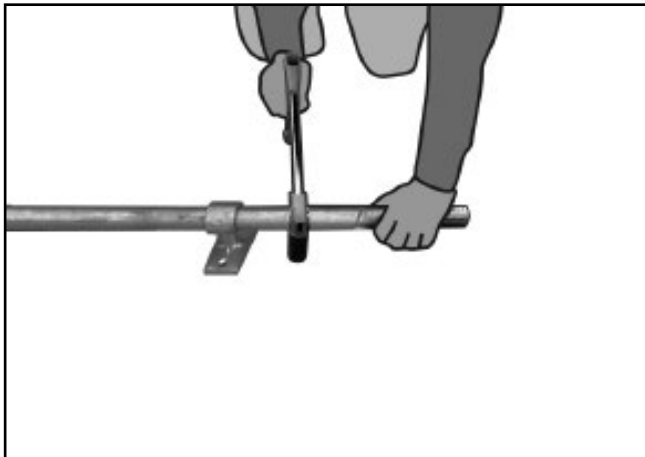

M. To avoid the risk of trip hazards from exposed tubing use a hacksaw or similar carefully cut through the excess lengths of tubes as shown, leaving approximately 50mm of tube exposed. For galvanised assemblies, spray with Galvafoid or similar to prevent corrosion.

Caution! Ensure all fittings are sufficiently torqued to 39Nm and panel is securely held onto roofing structure.



N. Using a 1/4" Allen Key/torque wrench ensure all fittings are torqued to 39Nm. Place plastic end caps on exposed ends of tubes to ensure minimal water ingress



Note:- Installing Kee Cover®:- Working at height is dangerous and skylights may not be suitable to bear any weight. When installing Kee Cover® always use appropriate fall protection equipment!



Exploded Diagram

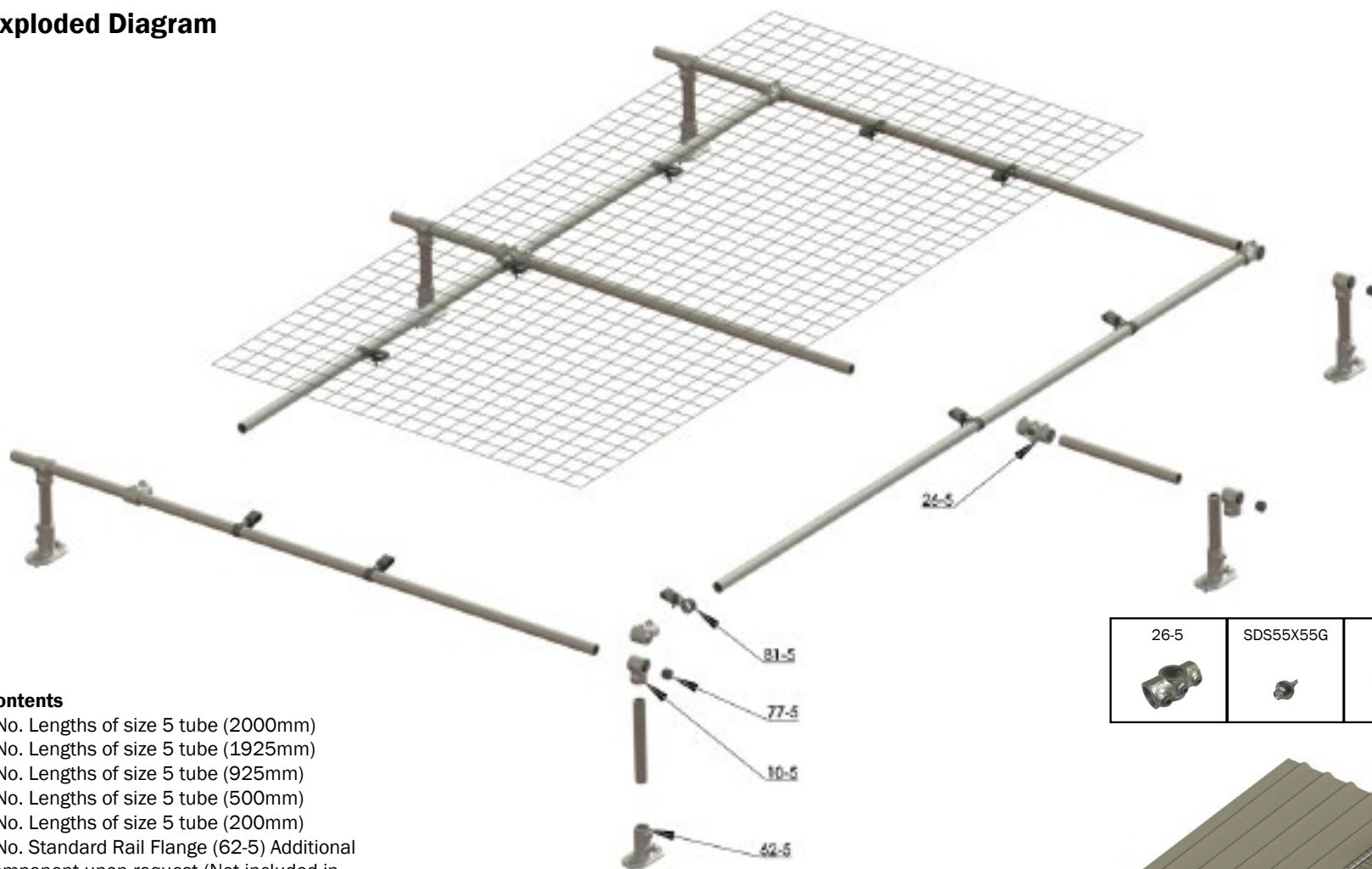

Contents

- 2No. Lengths of size 5 tube (2000mm)
- 2No. Lengths of size 5 tube (1925mm)
- 1No. Lengths of size 5 tube (925mm)
- 2No. Lengths of size 5 tube (500mm)
- 6No. Lengths of size 5 tube (200mm)
- 6No. Standard Rail Flange (62-5) Additional component upon request (Not included in standard kit) 6No. KCFP1 (Standing Seam Roofs Only)
- 10No. Single Socket Tee (10-5)
- 4No. Two Socket Cross (26-5)
- 10No. Single Sided Clips (81-5)
- 1No. Mesh Panel (WMP8023)
- 1No. 1m roll of Sealing Strip (TA-Seal)
- 12No. Self Drilling Screws (SDS55X55G)
- 2No. Cable Ties
- 1No. System Plaque (KCIDPLA01)

26-5	SDS55X55G	TA-SEAL	Cable Tie	KCIDPLA01

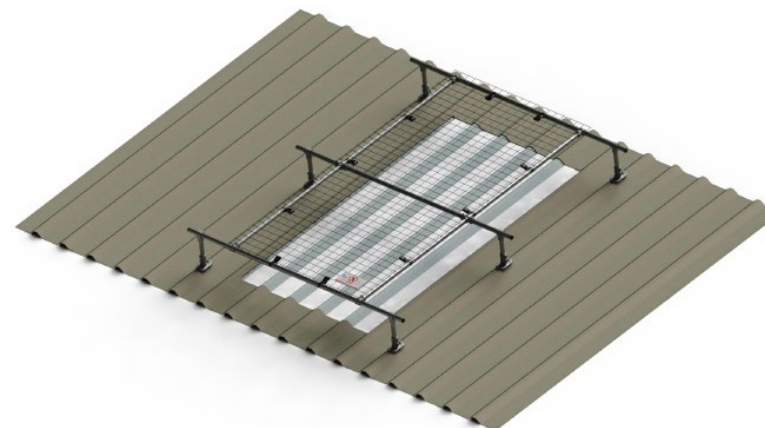



TOOLS REQUIRED

You will need the following in order to install the Kee Cover®:

- Marker Pen
- Tape Measure
- 2No. 10mm Ring Spanners
- 1/4" Allen Key
- Torque Wrench 10- 60 Nm approx
- Small Magnetic Level

Assembly and Mounting of Kee Cover®.

Please use adequate fall protection equipment when installing Kee Cover®. Failure to do so could result in Death or serious injury!



A. Carefully open packaging and check all the kit listed on previous page has been delivered.

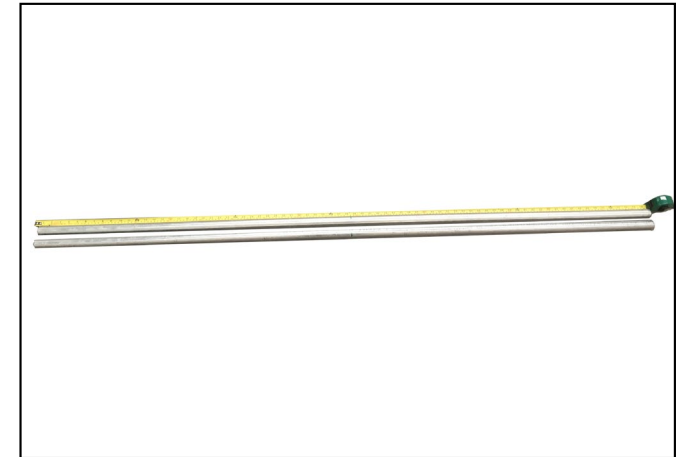

B. Select the 2No. lengths of size 5 tube (2000mm) and measure & mark the centre point of each of the tubes.

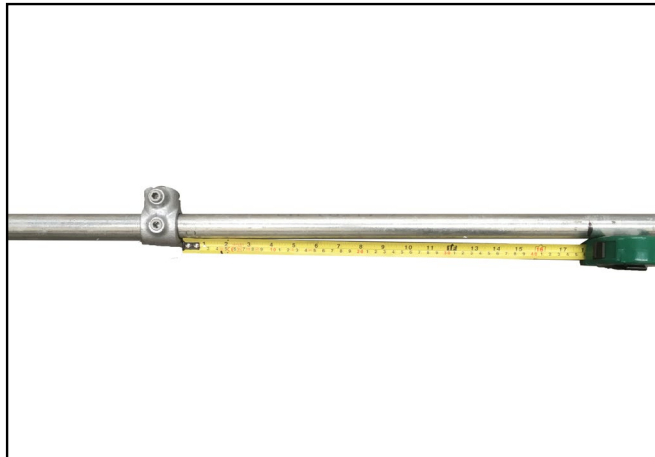

C. Carefully measure 455mm from each side of the centre point and mark. Slide a (10-5) Single Socket Tee to align with each of the four marked position, rotate fitting to ensure correct orientation (see stage E) and tighten the grub screws using a 1/4" Allen Key. NB If further extension panels are to be used then replace 2no. (10-5) Single Socket Tee for 2No. (26-5) Two Socket Cross fittings as this will permit further panels to be linked.



D. Select the 2No. 1925mm lengths of tube and measure and mark the centre of each tube. Slide a (26-5) fitting on to each of the tubes and place the fitting on the centre mark of each tube. Tightening the grub screws using a 1/4" Allen Key. Connect the tubes together and this will now form a large rectangle (frame).

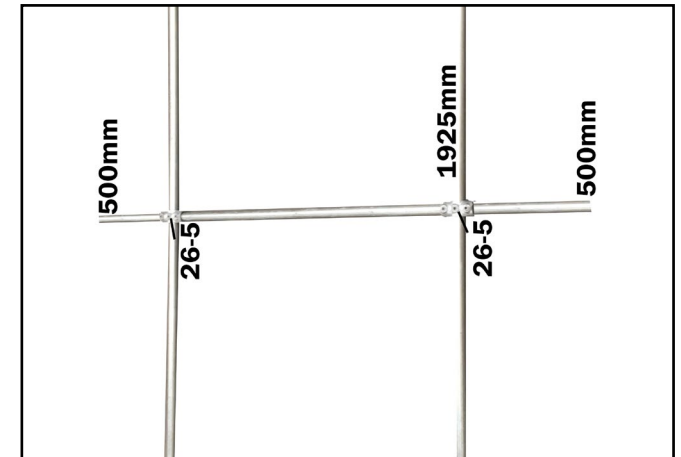

E. Insert 1No. 925mm tube to centre section and insert 2No.500mm tubes on to the ends of the (26-5). See diagram above to ensure frame is formed correctly.

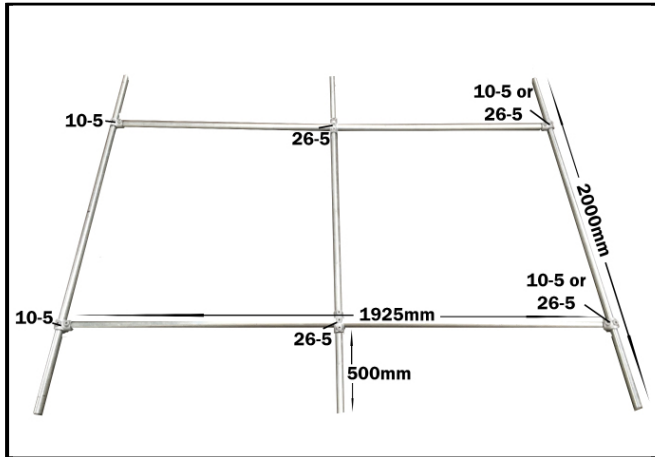

F. Check the frame is the same as the diagram above and using a 1/4" Allen Key ensure all grub screws are finally tightened.

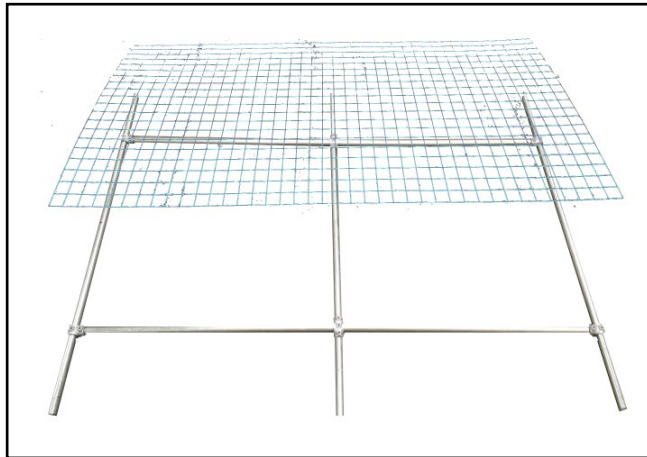

G. Carefully overlay mesh panel onto the frame. The mesh panel will be slightly larger than the frame itself.

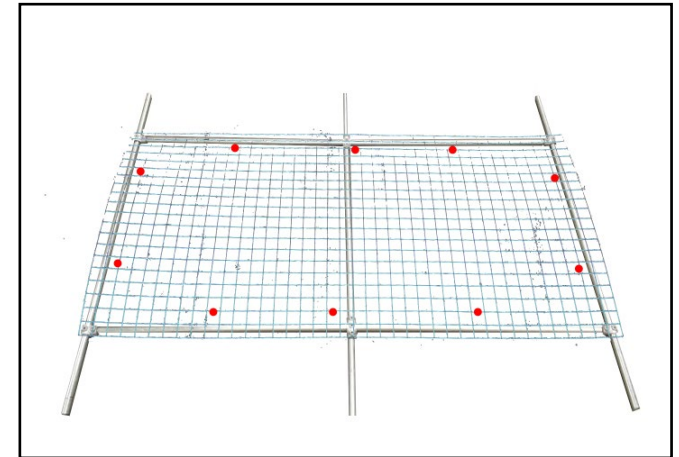

H. To connect the Mesh Panel and Frame together with the 10No. (81-5) Single Sided Clips. Position the Single Sided Clips as per diagram above.



I. Mesh panel clips are to be attached as above, 2 squares in from the edge of the mesh panel.

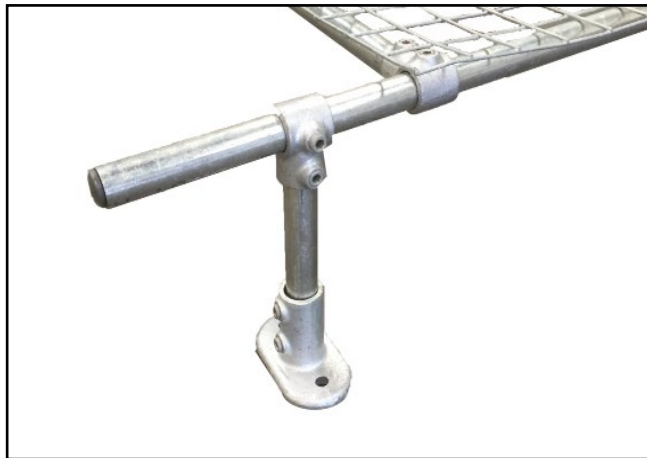

J. Assemble 6No. legs as above diagram using a (62-5) Standard Rail Flange fitting and a (10-5) Single Socket Tee fittings and 200mm tube. Line up with crowns of roofing material and tighten to 39Nm.

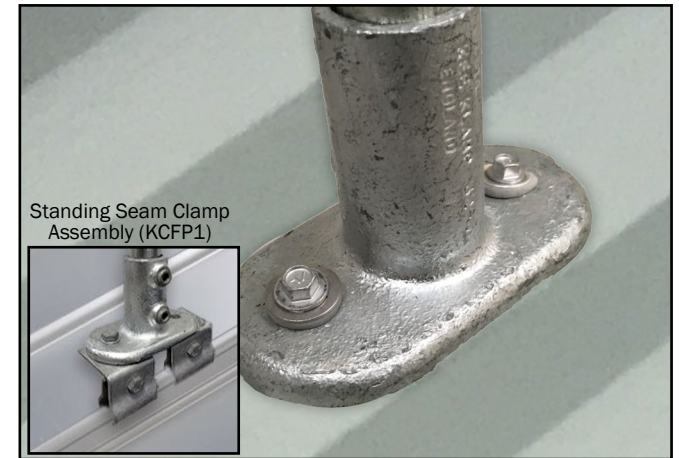

K. Carefully cut 6No. 120mm lengths of sealing strip. Place the Sealing Strip between the 6No. Standard Rail Flange fittings and the roof structure. Use Self Drilling Screws (SDS55X550) to attach the screen onto the roofing sheet. NB If attaching to standing seam roof use KCFP1 clamps to connect to the standing seam and bolt the 62-5 fitting to the KCFP1 clamp as shown in the diagram.

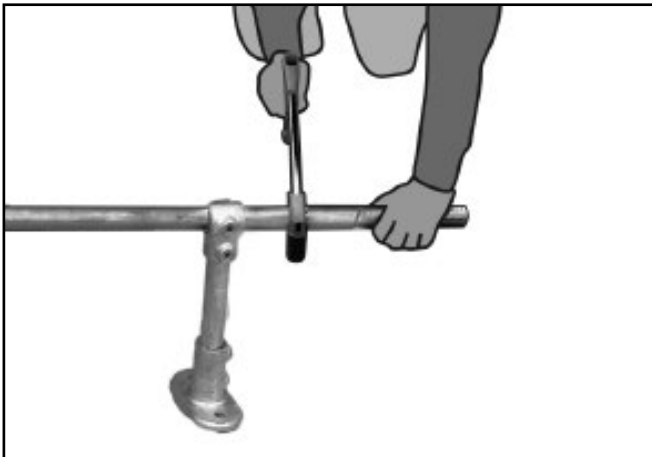

L. To avoid the risk of trip hazards from exposed tubing use a hacksaw or similar carefully cut through the excess lengths of tubes as shown, leaving approximately 50mm of tube exposed. For galvanised assemblies, spray with Galvafoid or similar to prevent corrosion.

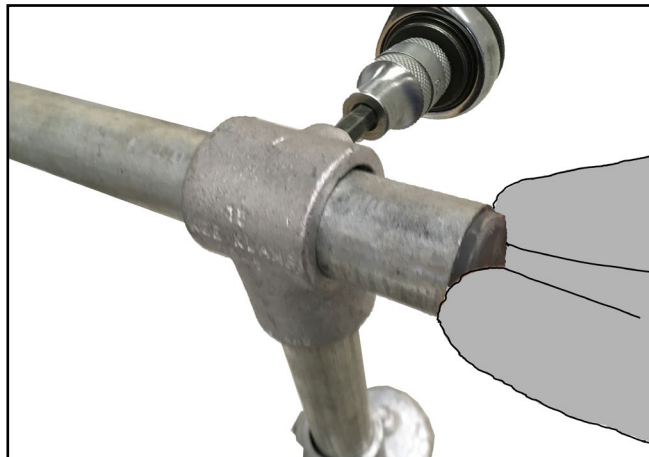

M. Use 1/4" Allen Key to ensure all fittings are torqued to 39Nm. Place plastic end caps on exposed ends of tubes to insure minimal water ingress

Caution! Ensure all fittings are sufficiently torqued to 39Nm and panel is securely held onto roofing structure.



N. Place identification plaque on screen and complete installer details. Secure in place using supplied cable ties.

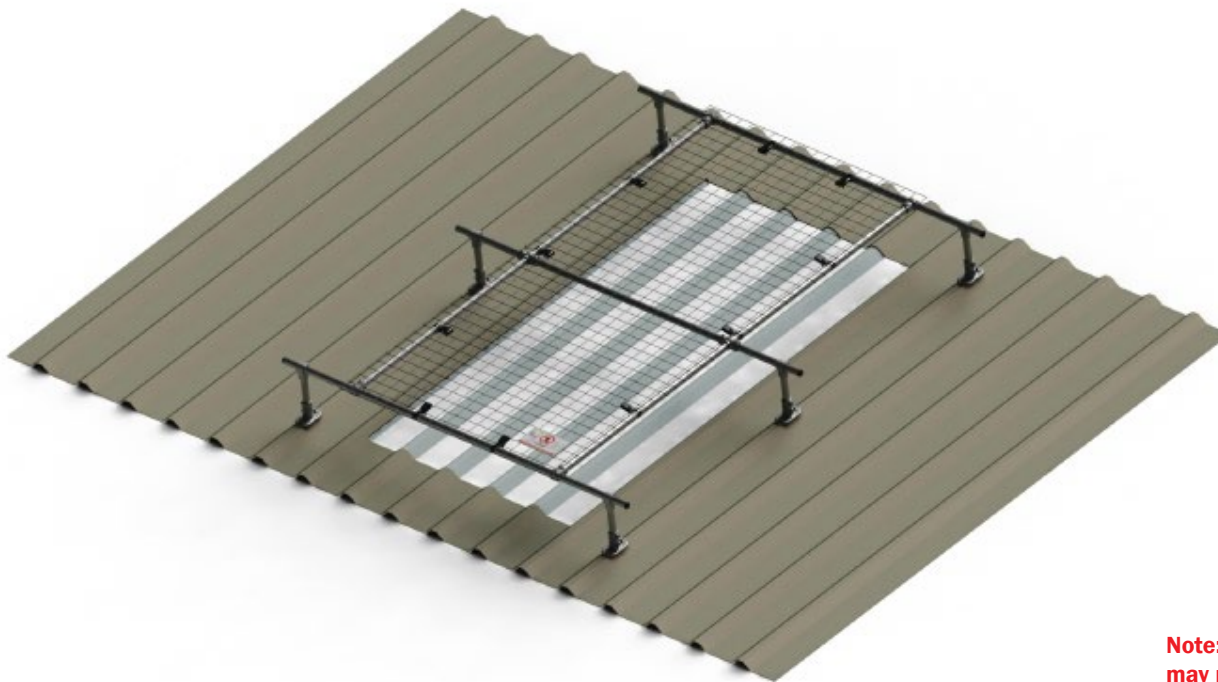

Note:- Installing Kee Cover®:- Working at height is dangerous and skylights may not be suitable to bear any weight. When installing Kee Cover® always use appropriate fall protection equipment!

Exploded Diagram

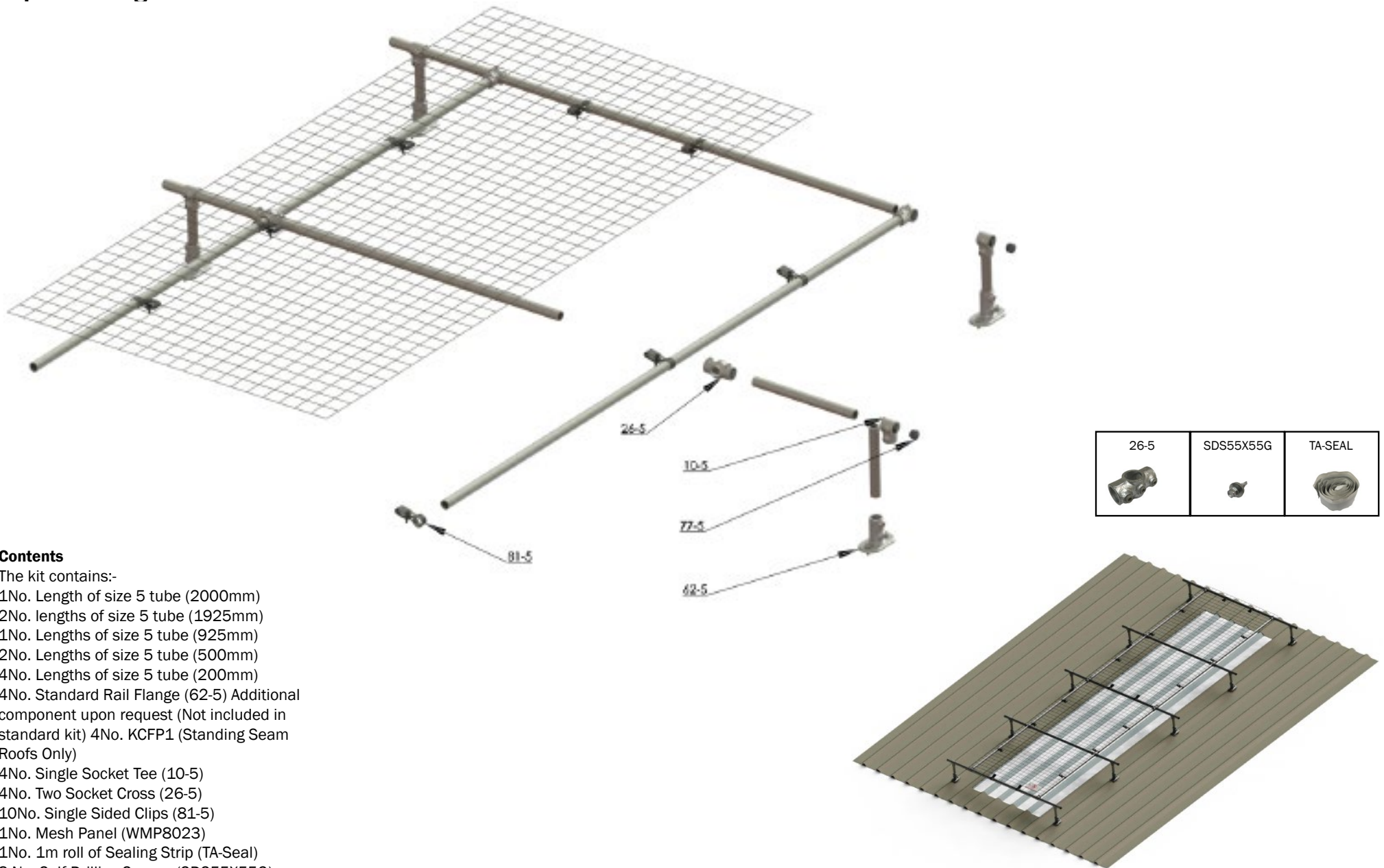

26-5	SDS55X55G	TA-SEAL

Contents

The kit contains:-

- 1No. Length of size 5 tube (2000mm)
- 2No. lengths of size 5 tube (1925mm)
- 1No. Lengths of size 5 tube (925mm)
- 2No. Lengths of size 5 tube (500mm)
- 4No. Lengths of size 5 tube (200mm)
- 4No. Standard Rail Flange (62-5) Additional component upon request (Not included in standard kit)
- 4No. KCFP1 (Standing Seam Roofs Only)
- 4No. Single Socket Tee (10-5)
- 4No. Two Socket Cross (26-5)
- 10No. Single Sided Clips (81-5)
- 1No. Mesh Panel (WMP8023)
- 1No. 1m roll of Sealing Strip (TA-Seal)
- 8 No. Self Drilling Screws (SDS55X55G)



TOOLS REQUIRED

You will need the following in order to install the Kee Cover®:

- Marker Pen
- Tape Measure
- 2No. 10mm Ring Spanners
- 1/4" Allen Key
- Torque Wrench 10- 60 Nm approx
- Small Magnetic Level

Assembly and mouting of Kee Cover®.

Please use adequate fall protection equipment when installing Kee Cover®. Failure to do so could result in Death or serious injury!

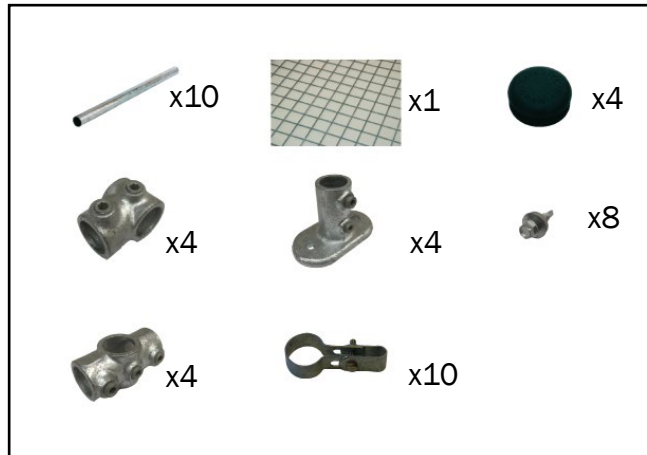

A. Carefully open packaging and check all the kit listed on previous page has been delivered.

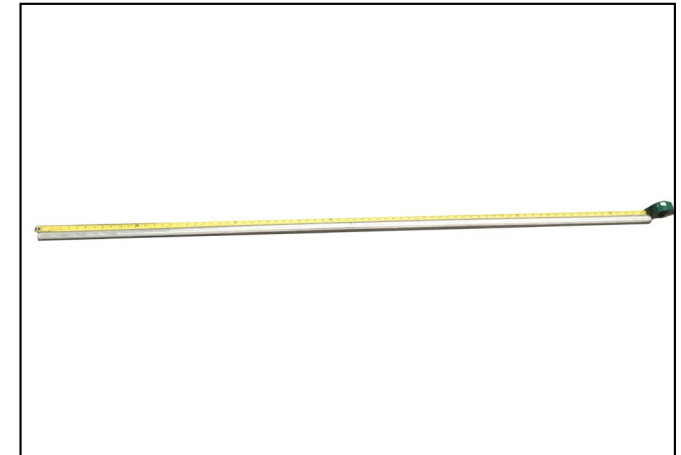

B. Select the 1No. length of size 5 tube (2000mm) and measure & mark the centre point of the tube.

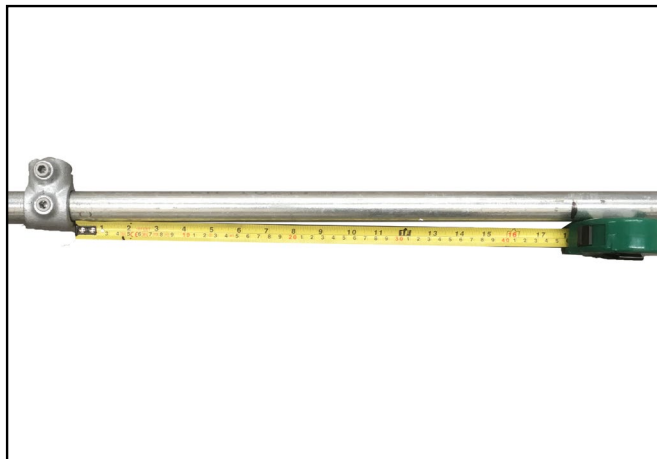

C. Measure 495mm from the centre point of the 2000mm tube and slide a (10-5) Single Socket Tee into both of the marked positions. Tighten the grub screws using a 1/4" Allen Key. NB If further extension panels are to be used then replace 2No. (10-5) Single Socket Tee for 2No. (26-5) Two Socket Cross fittings as this will permit further panels to be linked.

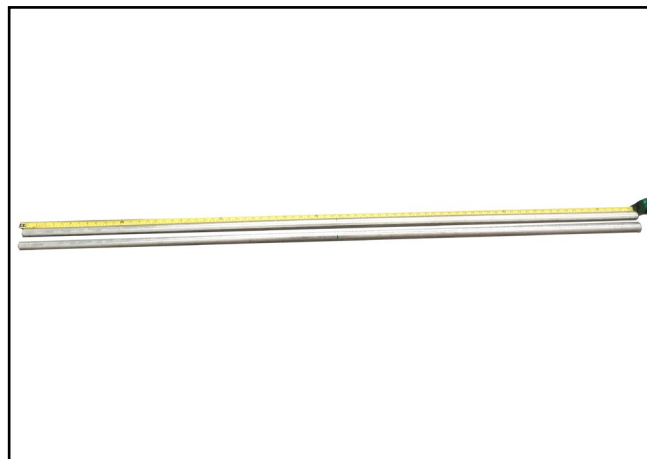

D. Select the 2No. 1925mm lengths of tube and measure and mark the centre of each tube. Slide a (26-5) fitting on to each of the tubes mounting the fitting on that centre mark, tightening the grub screws using a 1/4" Allen Key. Connect the tubes together and this will now form the shape shown in the next step.

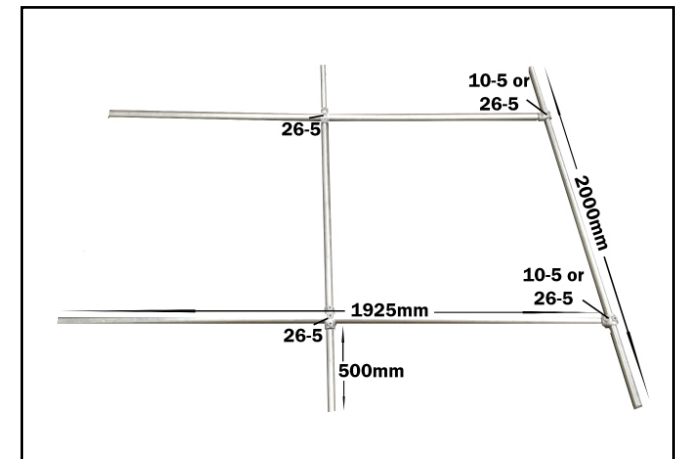

E. Insert 1No. 925mm tube to centre section and insert 2No. 500mm tubes on to the ends. See diagram above to ensure frame is formed correctly.

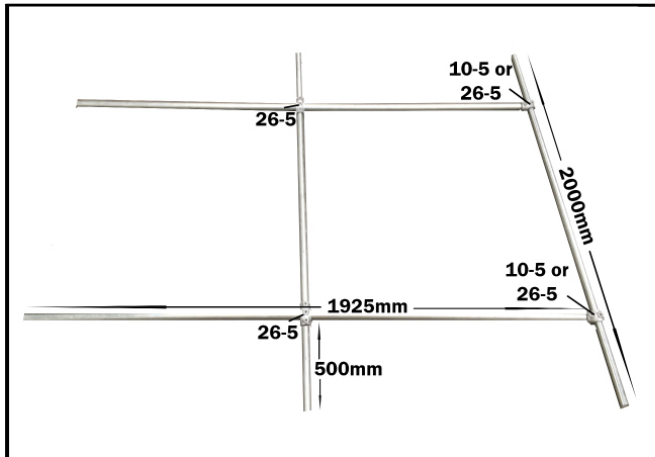

F. Check the frame is the same as the diagram above and using a 1/4" Allen Key ensure all grub screws are finally tightened.

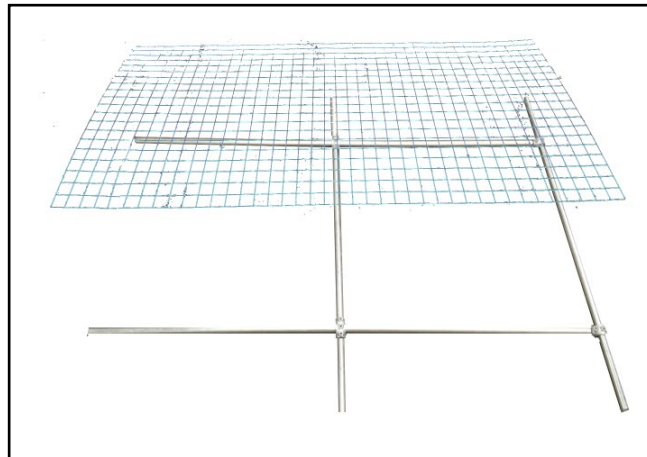

G. Carefully overlay mesh panel onto the frame. The mesh panel will be slightly larger than the frame itself.

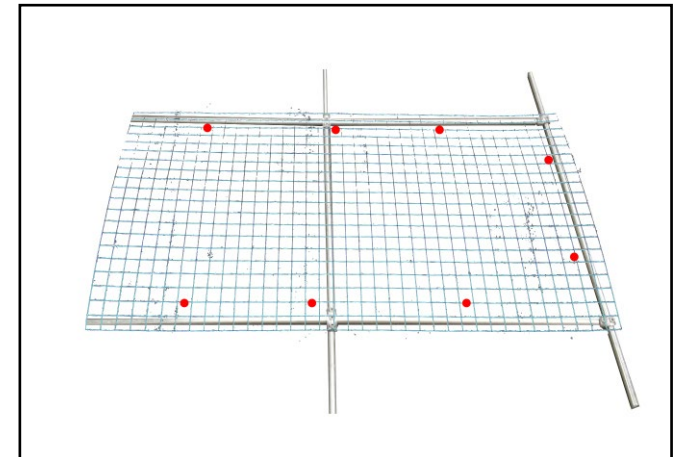

H. To connect the Mesh Panel and Frame together with 8No (81-5) Single Sided Clips. Position the Single Sided Clips as per diagram above.



I. Mesh panels clips are to be attached as diagram above, 2 squares in from the edge of the mesh panel.

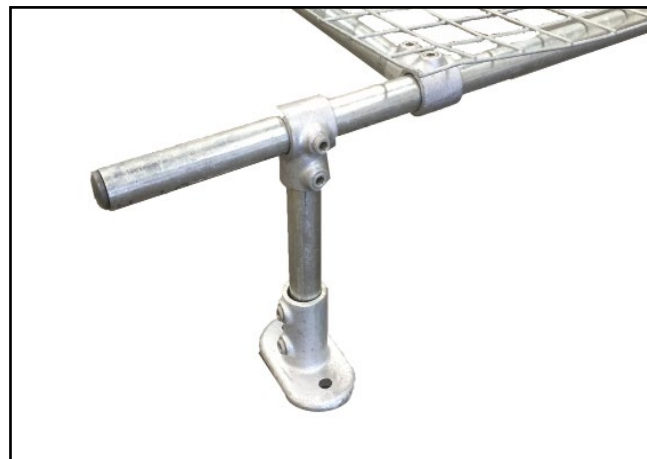

J. Assemble 4No. legs as above diagram using (62-5) Standard Rail Flange fitting and (10-5) Single Socket Tee fittings and 200mm tubes. Line up with crowns of roofing material and tighten to 39Nm.

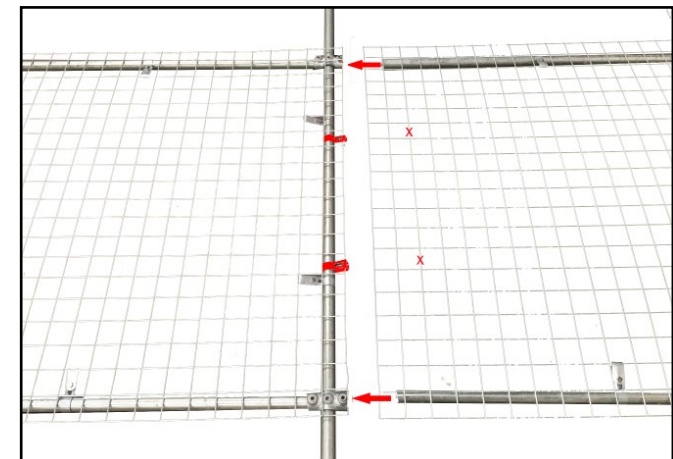

K. Insert extension panel tube ends into 26-5 of primary screen, slight lifting of the mesh may be required as there will be a slight overlap. Tighten grub screws. Secure extension mesh to primary panel by attaching 2no. mesh panel clips (shown in red) onto existing screen, then secure mesh to extension panel where red 'X' is shown.



Standing Seam Clamp
Assembly (KCFP1)

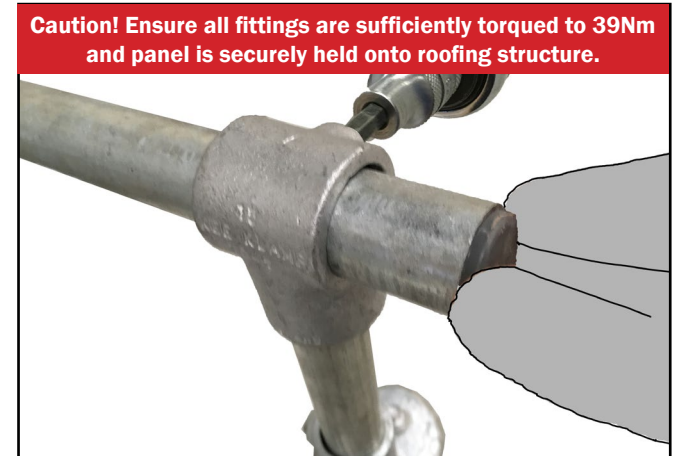
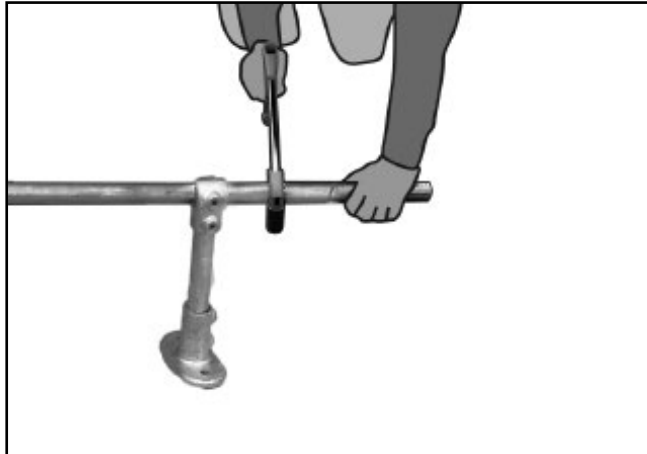

L. Carefully cut 4No. 120mm lengths of sealing strip. Place the Sealing Strip between the 4No. Standard Rail Flange fittings and the roof structure. Use Self Drilling Screws (SDS55X550) to attach the screen onto the roofing sheet. NB If attaching to standing seam roof use KCFP1 clamps to connect to the standing seam and bolt the 62-5 fitting to the KCFP1 clamp as shown in the diagram.

M. To avoid the risk of trip hazards from exposed tubing use a hacksaw or similar carefully cut through the excess lengths of tubes as shown, leaving approximately 50mm of tube exposed. For galvanised assemblies, spray with Galvafoid or similar to prevent corrosion.

N. Using a 1/4" Allen key/torque wrench ensure all fittings are torqued to 39Nm. Place plastic end caps on exposed ends of tubes to ensure minimal water ingress

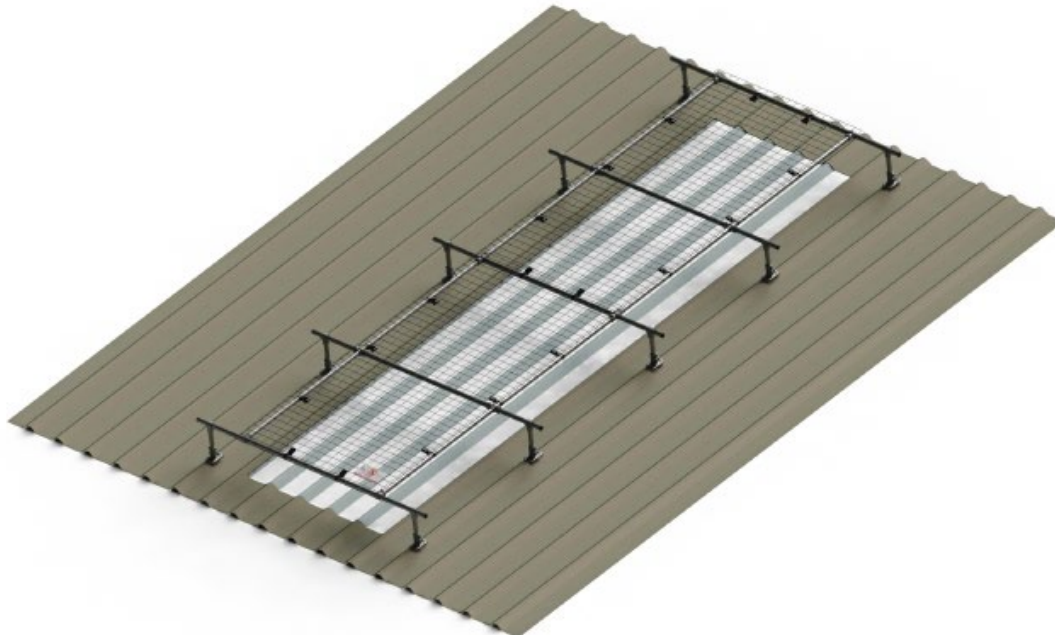

Note:- Installing Kee Cover®:- Working at height is dangerous and skylights may not be suitable to bear any weight. When installing Kee Cover® always use appropriate fall protection equipment!

Exploded Diagram

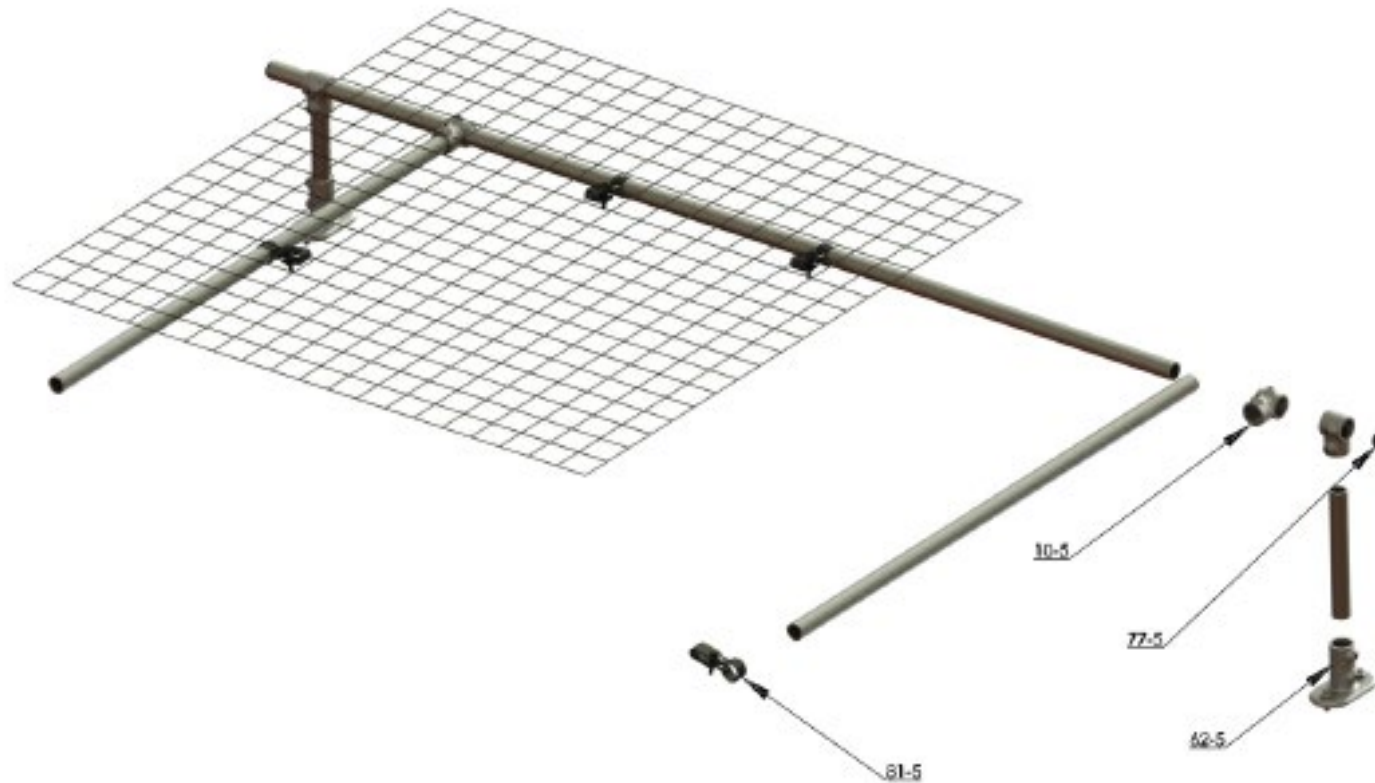

Contents

The kit contains:-

- 1No. Length of size 5 tube (2000mm)
- 2No. Lengths of size 5 tube (925mm)
- 2No. Lengths of size 5 tube (200mm)
- 2No. Standard Rail Flange (62-5) Additional component upon request (Not included in standard kit)
- 6No KCFP1 (Standing Seam Roofs Only)
- 4No. Single Socket Tee (10-5)
- 2No. Two Socket Cross (26-5)
- 8No. Single Sided Clips (81-5)
- 1No. Mesh Panel (WMP4023)
- 1No. 1m roll of Sealing Strip (TA-Seal)
- 4 No. Self Drilling Screws (SDS55X55G)

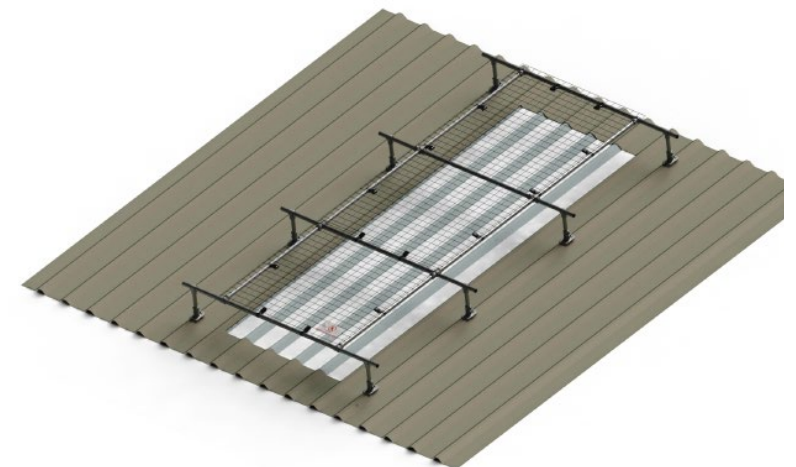



TOOLS REQUIRED

You will need the following in order to install the Kee Cover®:

- Marker Pen
- Tape Measure
- 2No. 10mm Ring Spanners
- 1/4" Allen Key
- Torque Wrench 10- 60 Nm approx
- Small Magnetic Level

Assembly and mouting of Kee Cover®.

Please use adequate fall protection equipment when installing Kee Cover®. Failure to do so could result in Death or serious injury!

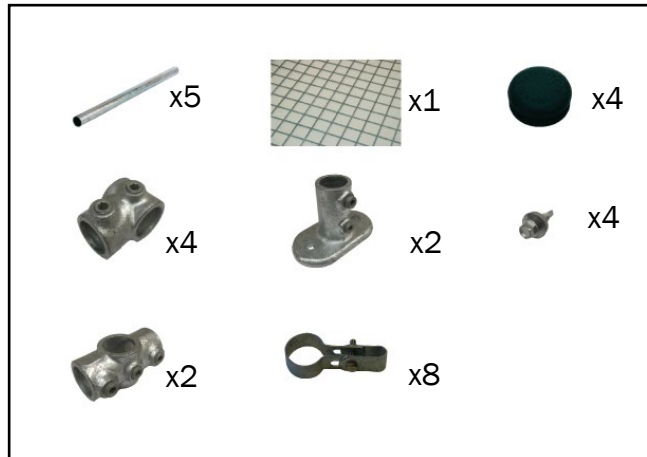

A. Carefully open packaging and check all the kit listed on previous page has been delivered.

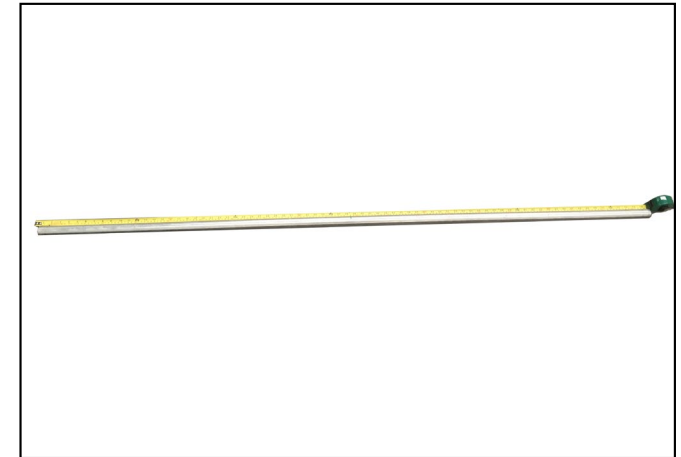

B. Select the 1No. length of size 5 tube (2000mm) and measure & mark the centre point of the tube.

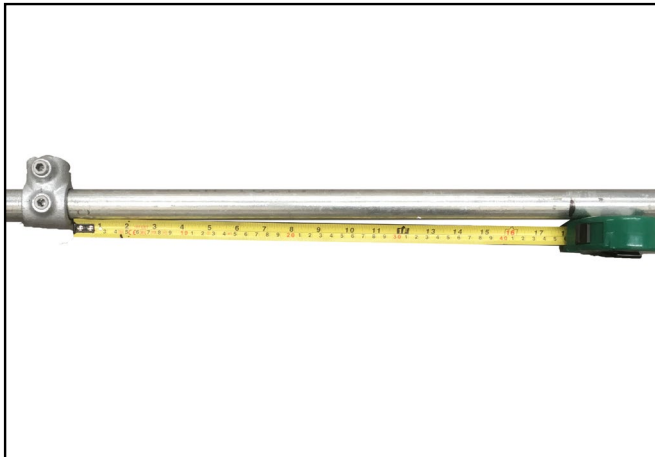

C. Carefully measure 455mm from each side of the centre point and mark. Slide a (10-5) Single Socket Tee to align with each of the four marked position, rotate fitting to ensure correct orientation (see stage E) and tighten the grub screws using a 1/4" Allen Key. NB If further extension panels are to be used then replace 2no. (10-5) Single Socket Tee for 2No. (26-5) Two Socket Cross fittings as this will permit further panels to be linked.

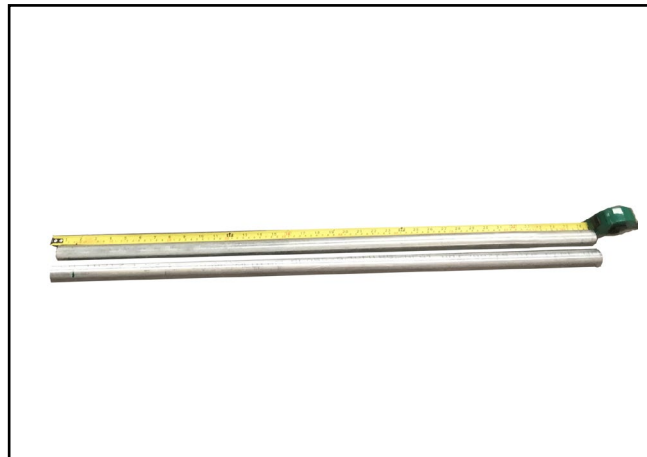

D. Select the 2No. 925mm lengths of tube and insert the tubes into the (10-5) fittings mounted on the 1No. 2000mm length of size 5 tube. Tighten the grub screws using a 1/4" Allen Key. This will now form a large U Extension (frame).

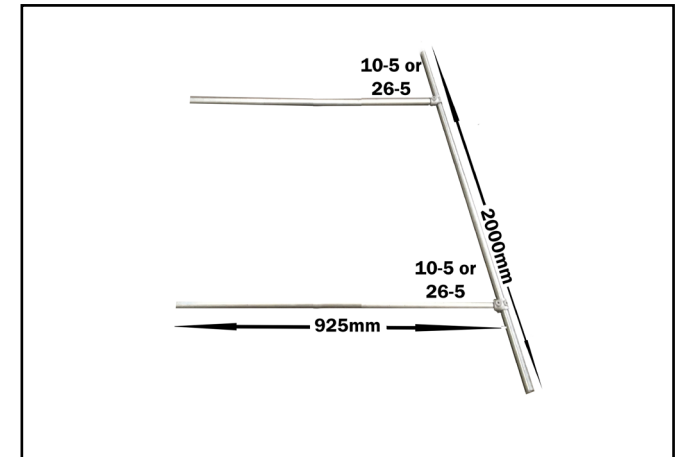

F. See diagram above to ensure frame formed correctly.

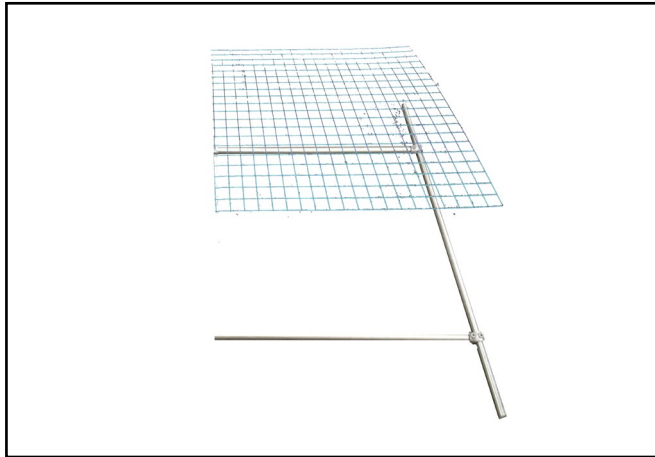

G. Carefully overlay mesh panel onto the frame. The mesh panel will be slightly larger than the frame itself.

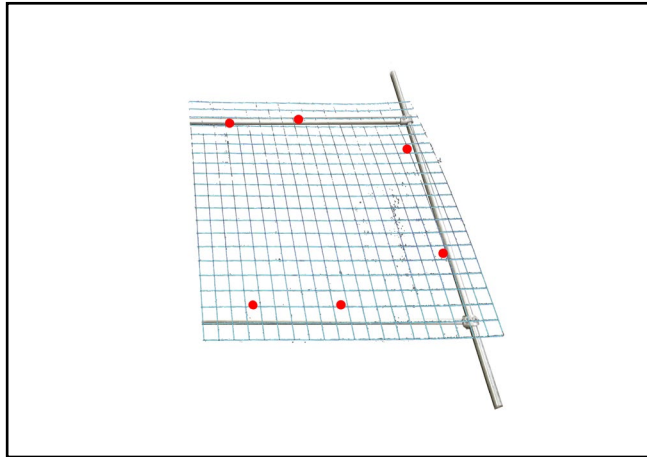

H. To connect the Mesh Panel and Frame together with the 6No. (81-5) Single Sided Clips. Position the Single Sided Clips as per diagram above.



I. Mesh panels clips are to be attached as diagram above, 2 squares in from the edge of the mesh panel.

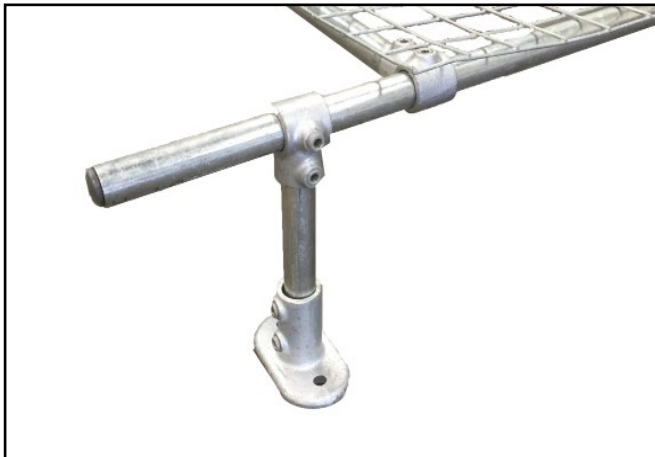

J. Assemble 2No. legs as above diagram using (62-5) Standard Rail Flange fitting and (10-5) Single Socket Tee fittings and 200mm tubes. Line up with crowns of roofing material and tighten to 39Nm.

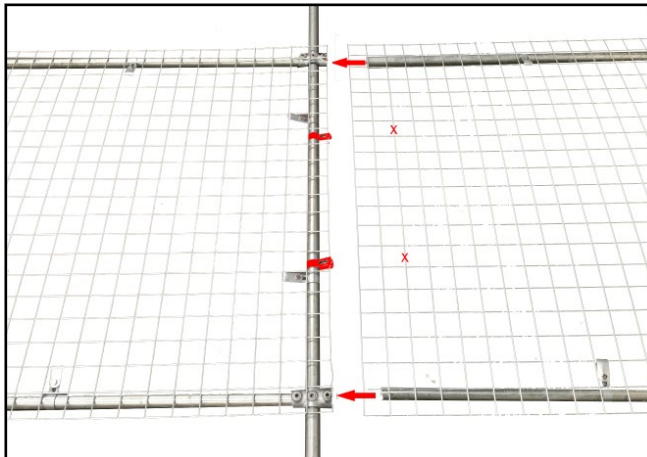

K. Insert extension panel tube ends into 26-5 of primary screen, slight lifting of the mesh may be required as there will be a slight overlap. Tighten grub screws. Secure extension mesh to primary panel by attaching 2no. mesh panel clips (shown in red) onto existing screen, then secure mesh to extension panel where red 'X' is shown.

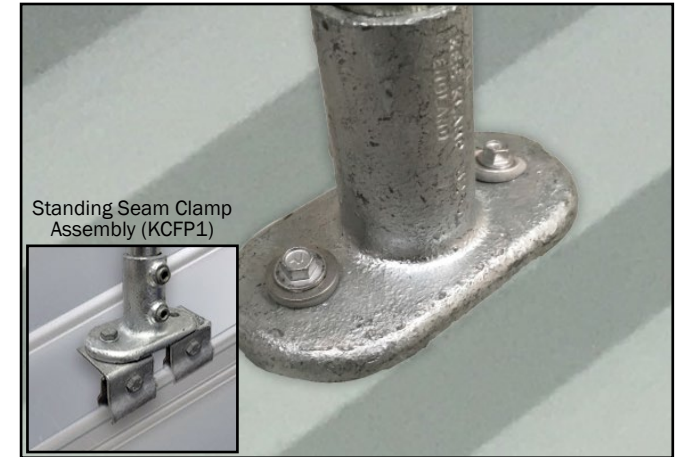

L. Carefully cut 2No. 120mm lengths of sealing strip. Place the Sealing Strip between the 2No. Standard Rail Flange fittings and the roof structure. Use Self Drilling Screws (SDS55X550) to attach the screen onto the roofing sheet. NB If attaching to standing seam roof use KCFP1 clamps to connect to the standing seam and bolt the 62-5 fitting to the KCFP1 clamp as shown in the diagram.

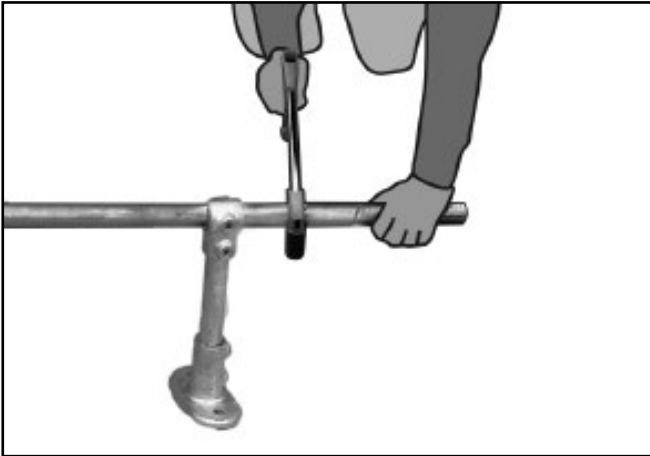

M. To avoid the risk of trip hazards from exposed tubing use a hacksaw or similar carefully cut through the excess lengths of tubes as shown, leaving approximately 50mm of tube exposed. For galvanised assemblies, spray with Galvafoid or similar to prevent corrosion.

Caution! Ensure all fittings are sufficiently torqued to 39Nm and panel is securely held onto roofing structure.

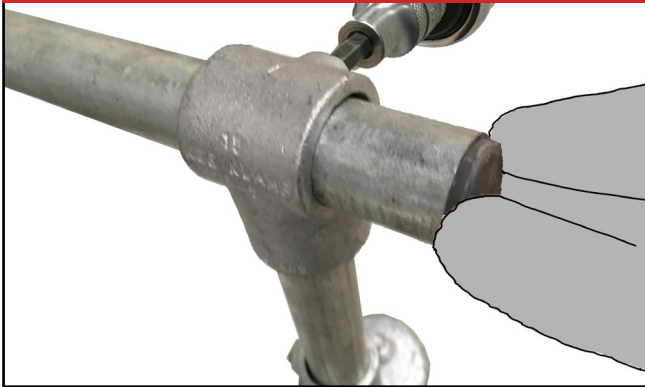

N. Using a 1/4" Allen key/torque wrench ensure all fittings are torqued to 39Nm. Place plastic end caps on exposed ends of tubes to ensure minimal water ingress

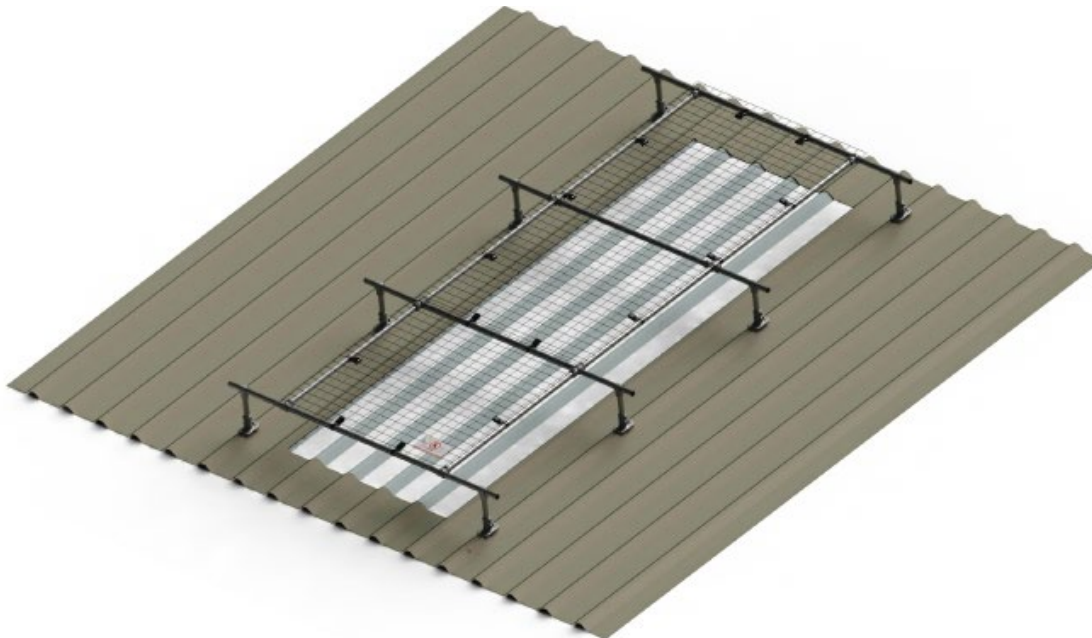

Note:- Installing Kee Cover®:- Working at height is dangerous and skylights may not be suitable to bear any weight. When installing Kee Cover® always use appropriate fall protection equipment!

Exploded Diagram

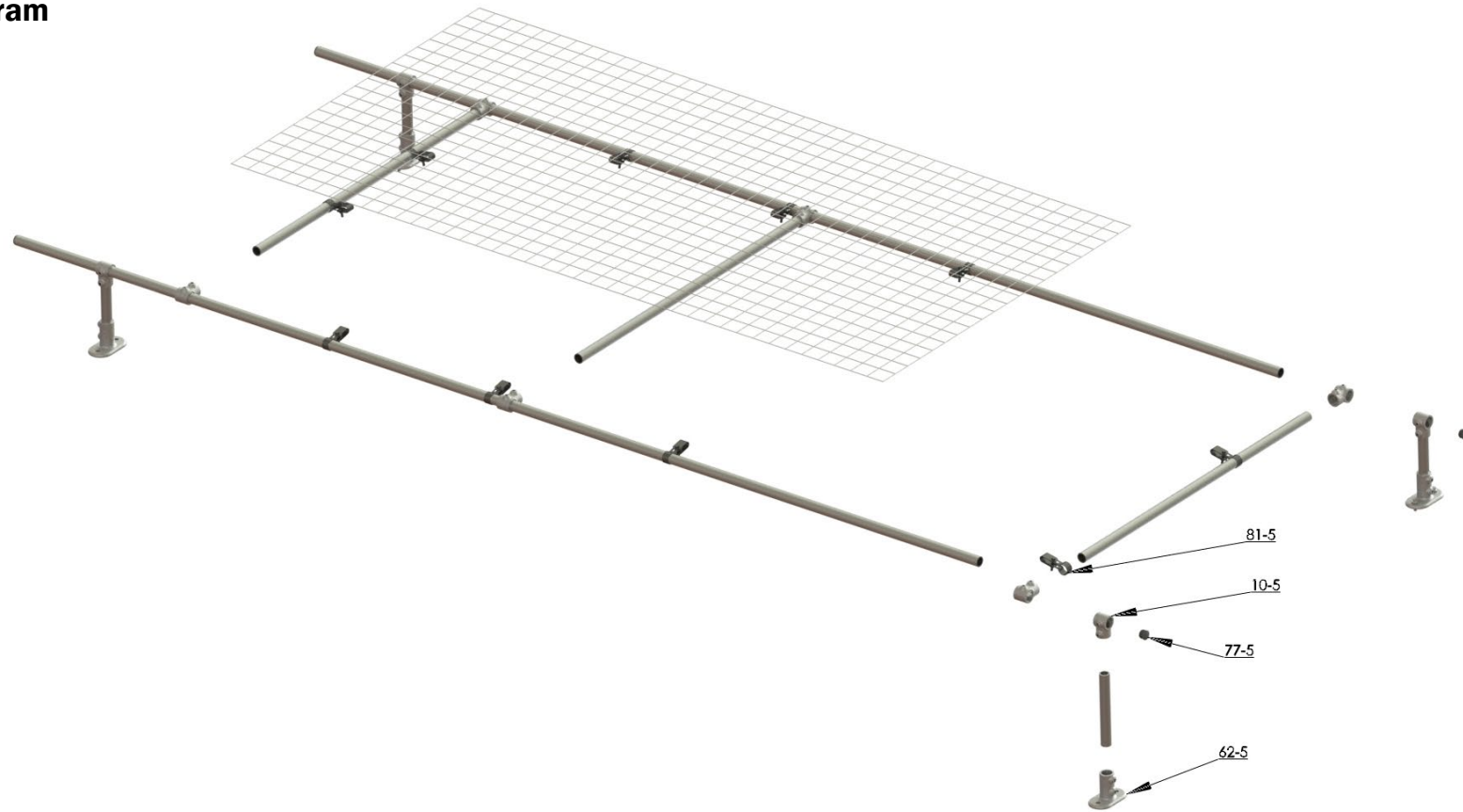

Contents

- 2No. Lengths of size 5 tube (3000mm)
- 3No. Lengths of size 5 tube (925mm)
- 4No. Lengths of size 5 tube (200mm)
- 4No. Standard Railing Flange (62-5) Additional component upon request (Not included in standard kit) 4No KCFP1 (Standing Seam Roofs Only)
- 8No. Single Socket Tee (10-5)
- 3No. Two Socket Cross (26-5)
- 10No. Single Sided Clips (81-5)
- 1No. Mesh Panel (WMP8023)
- 1No. 1m roll of Sealing Strip (TA-Seal)
- 8No. Tek Screws (SDS55X55G)
- 2No. Cable Ties
- 1No. System Plaque (KCIDPLA01)

26-5	SDS55X55G	TA-SEAL	Cable Tie	KCIDPLA01





TOOLS REQUIRED

You will need the following in order to install the Kee Cover®:

- Marker Pen
- Tape Measure
- 2no. 10mm Ring Spanners
- 1/4" Allen Key
- Torque Wrench 10- 60 Nm approx
- Small Magnetic Level

Assembly and Mounting of Kee Cover®.

Please use adequate fall protection equipment when installing Kee Cover®. Failure to do so could result in Death or serious injury!

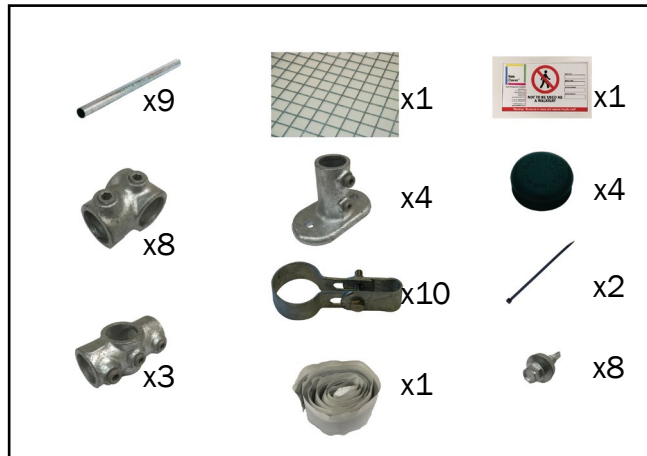

A. Carefully open packaging and check all the kit listed on previous page has been delivered.

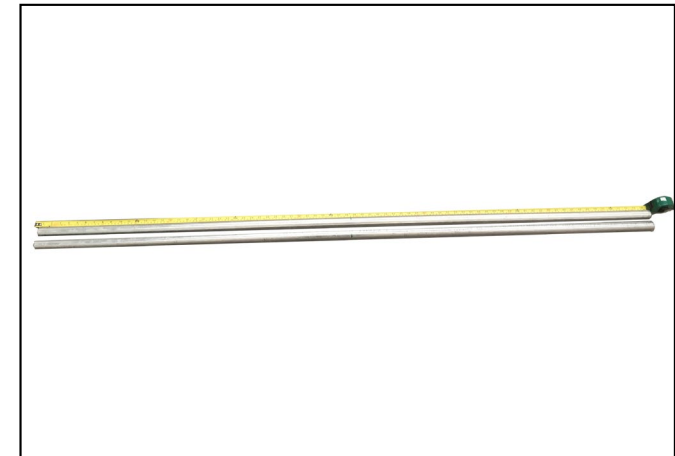

B. Select the 2No lengths of size 5 tube (3000mm) and measure & mark the centre point of each of the tubes.



C. Measure 995mm from the centre point of each of the 3000mm tubes and slide a (10-5) Single Socket Tee into each of the four marked position and tighten the grub screws using a 3/16" Allen Key. NB If further extension panels are to be used then replace 2no. (10-5) Single Socket Tee for 2No. (26-5) Two Socket Cross fittings this will permit further panels to be connected to the primary.

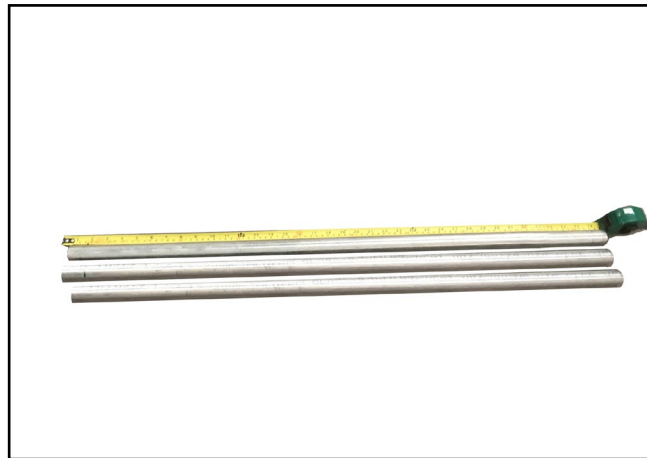

D. Select the 3No. 925mm lengths of tube and insert each of the tubes into the (10-5) Single Socket Tee mounted on the 2No. 3000mm lengths of size 5 tube and tighten the grub screws using a 1/4" Allen Key. This will now form a large rectangular frame.

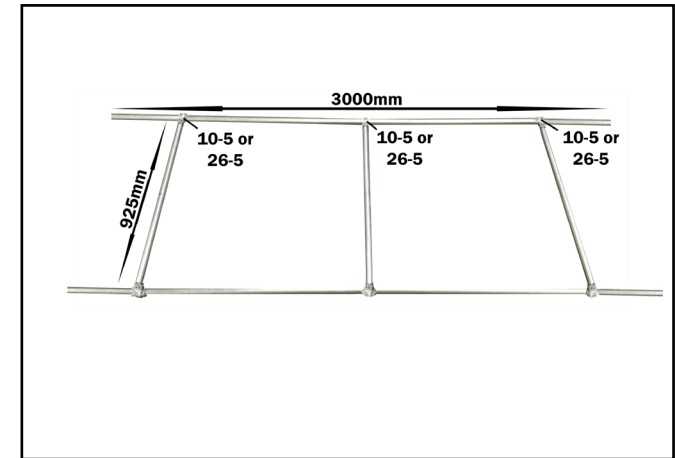

E. See diagram above to ensure frame formed correctly.

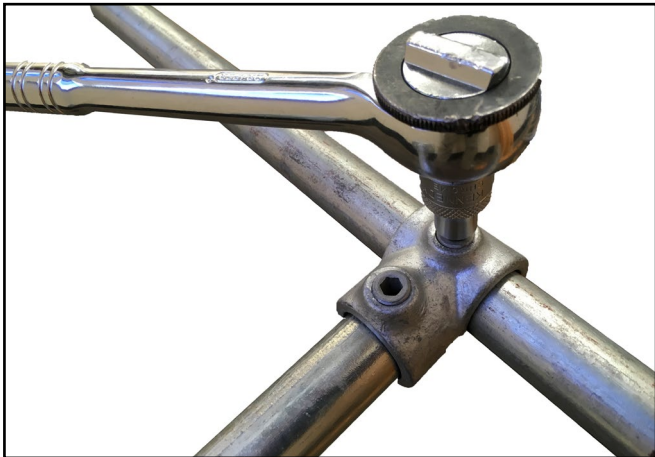

F. Using a 1/4" Allen Key ensure all grub screws are finally tightened.

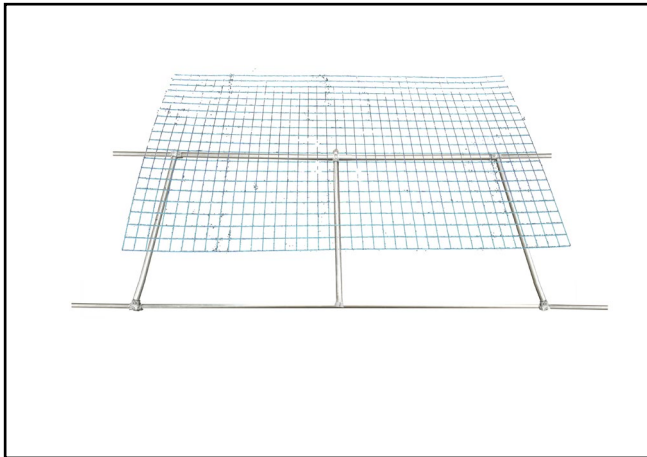

G. Carefully overlay mesh panel onto the frame. The mesh panel will be slightly larger than the frame itself.

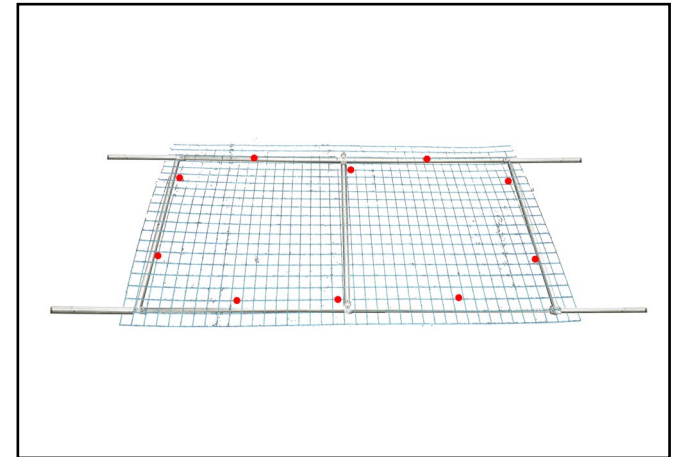

H. To connect the Mesh Panel and Frame together with the 10No. (81-5) Single Sided Clips. Position the Single Sided Clips as per diagram above.



I. Mesh panel clips are to be attached as above diagram.



J. Slide 1 No. Rail Flange fitting over each end of the exposed tube in the corners of the frame. Carefully align the fitting to ensure it is positioned on the crown of roof sheet.

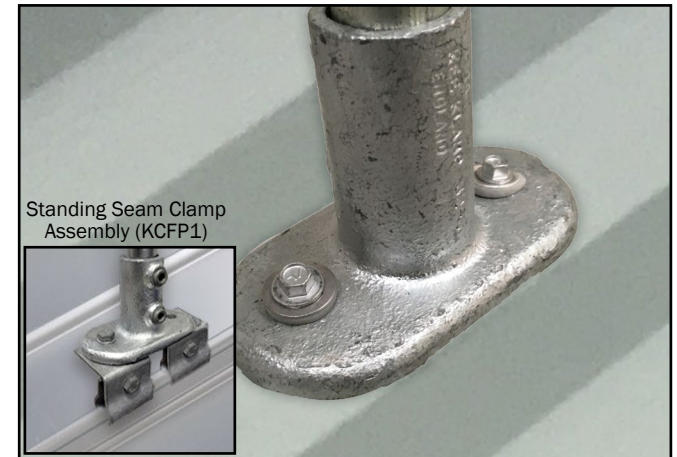

K. Carefully cut 6No. 120mm lengths of sealing strip. Place the Sealing Strip between the 6No. Standard Rail Flange fittings and the roof structure. Use Self Drilling Screws (SDS55X550) to attach the screen onto the roofing sheet. NB If attaching to standing seam roof use KCFP1 clamps to connect to the standing seam and bolt the 62-5 fitting to the KCFP1 clamp as shown in the diagram.

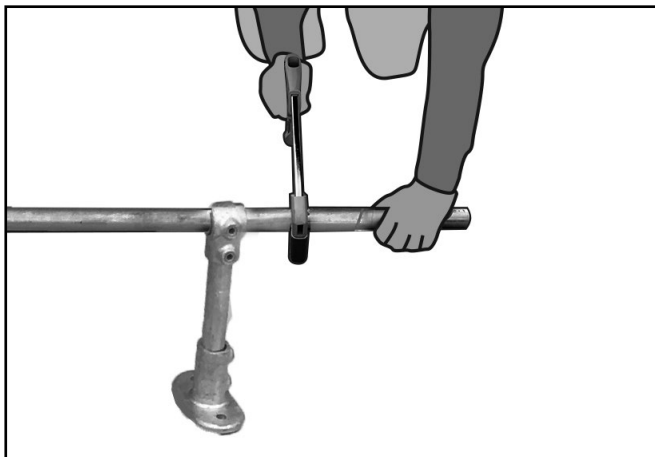

L. To avoid the risk of trip hazards from exposed tubing use a hacksaw or similar carefully cut through the excess lengths of tubes as shown, leaving approximately 50mm of tube exposed. For galvanised assemblies, spray with Galvafoid or similar to prevent corrosion.

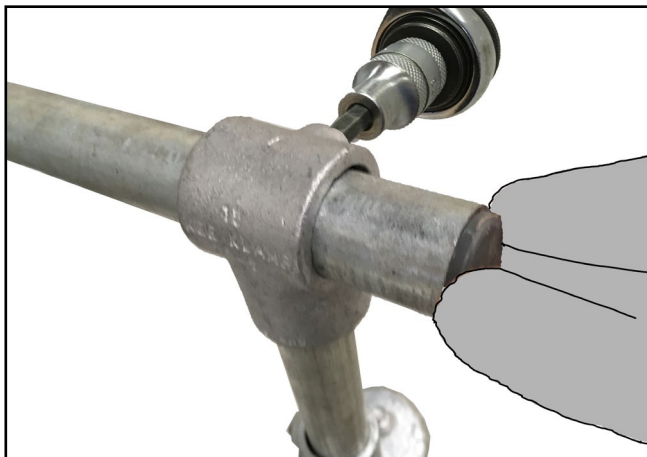

M. Using a 1/4" Allen key/torque wrench ensure all fittings are torqued to 39Nm. Place plastic end caps on exposed ends of tubes to ensure minimal water ingress

Caution! Ensure all fittings are sufficiently torqued to 39Nm and panel is securely held onto roofing structure.



N. Place identification plaque on screen and complete details, Secure plaque using supplied cable ties.



Note:- Installing Kee Cover®:- Working at height is dangerous and skylights may not be suitable to bear any weight. When installing Kee Cover® always use appropriate fall protection equipment!

Exploded Diagram

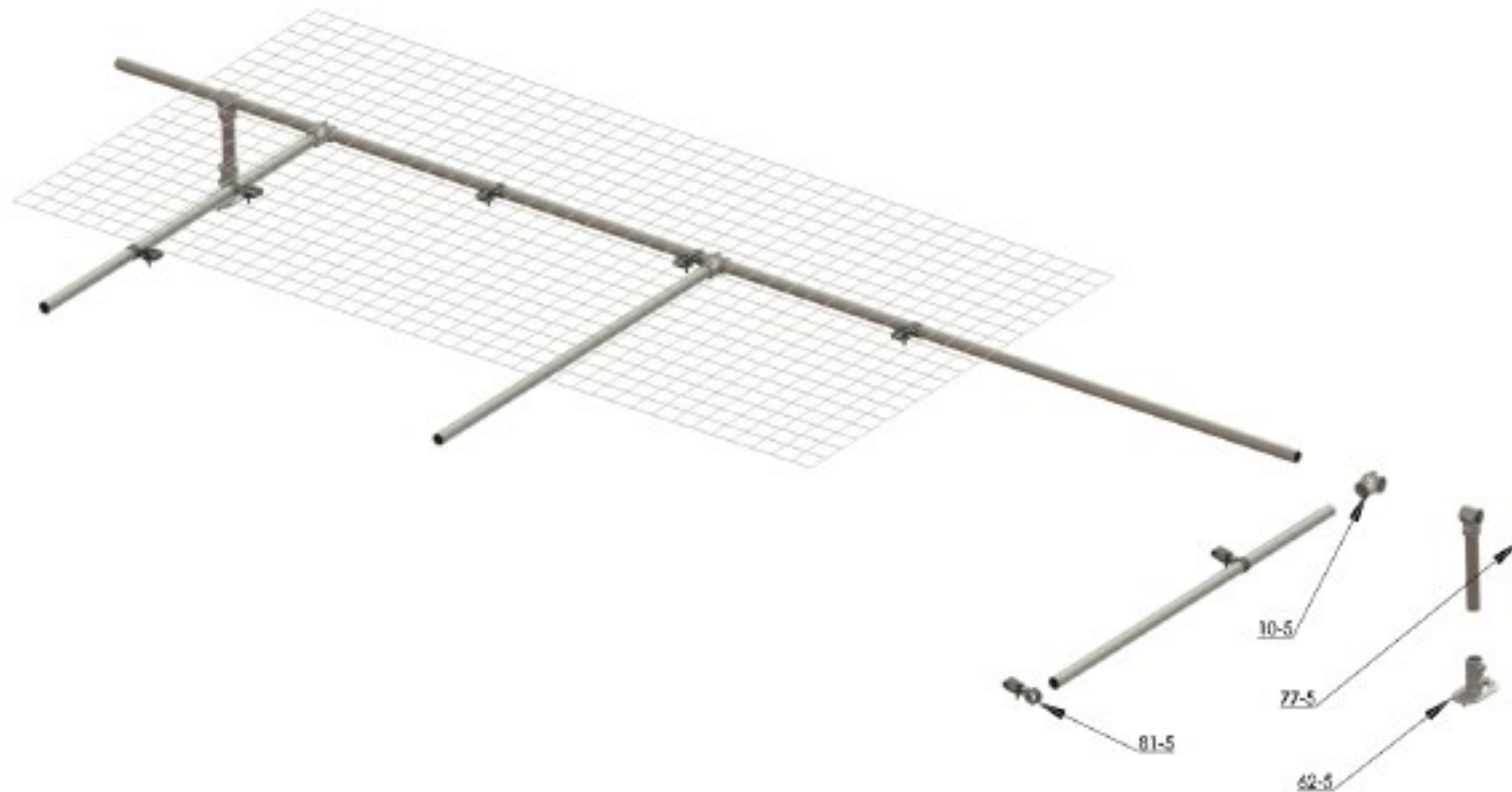

Contents

- 1No. Lengths of size 5 tube (3000mm)
- 3No. Lengths of size 5 tube (925mm)
- 2No. Lengths of size 5 tube (200mm)
- 2No. Standard Rail Flange (62-5) Additional component upon request (Not included in standard kit)
- 2No. KCFP1 (Standing Seam Roofs Only)
- 2No. Single Socket Tee (10-5)
- 3No. Two Socket Cross (26-5)
- 10No. Single Sided Clips (81-5)
- 1No. Mesh Panel (WMP8023)
- 1No. 1m roll of Sealing Strip (TA-Seal)
- 4No. Tek Screws (SDS55X55G)

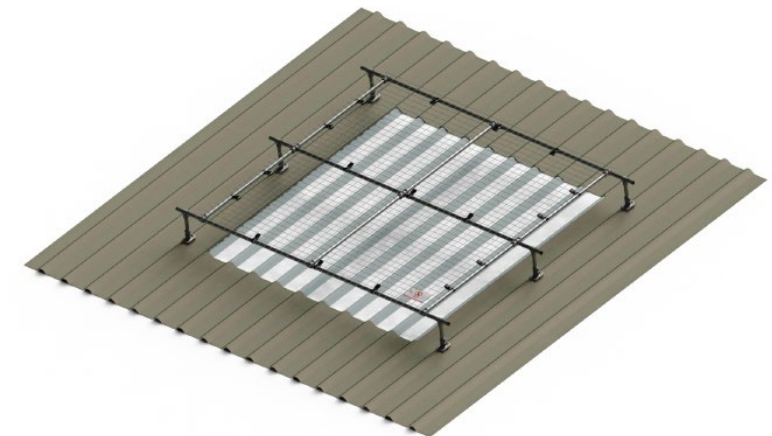



TOOLS REQUIRED

You will need the following in order to install the Kee Cover®:

- Marker Pen
- Tape Measure
- 2no. 10mm Ring Spanners
- 1/4" Allen Key
- Torque Wrench 10- 60 Nm approx
- Small Magnetic Level

Assembly and Mounting of Kee Cover®.

Please use adequate fall protection equipment when installing Kee Cover®. Failure to do so could result in Death or serious injury!

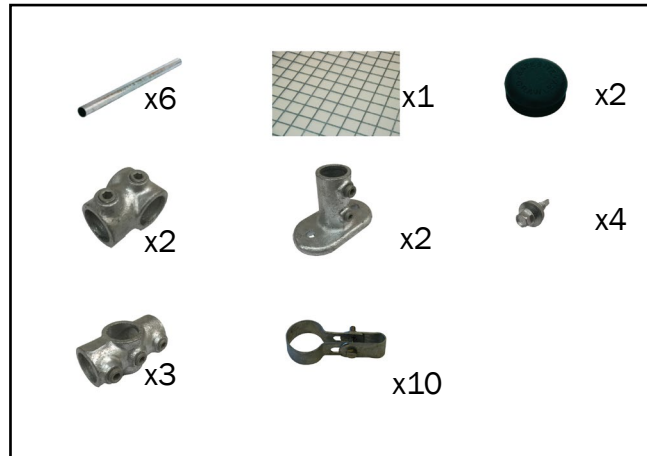

A. Carefully open packaging and check all the kit listed on previous page has been delivered.

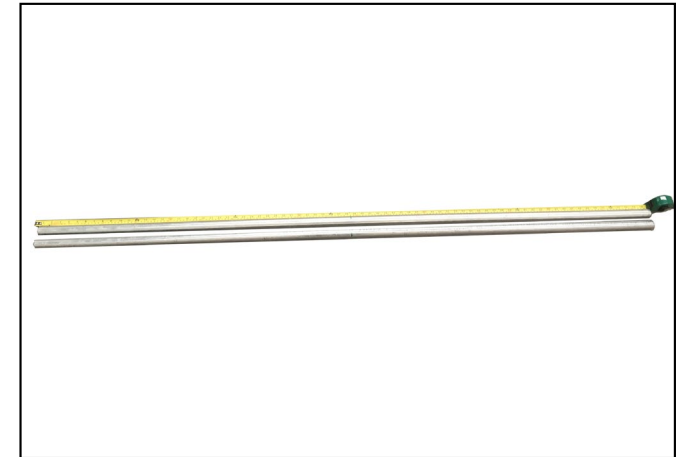

B. Select the 1No. 3000mm length of size 5 tube and measure & mark the centre point of the tube.



C. Measure 995mm from the centre point of the 3000mm tube and slide a (10-5) Single Socket Tee into both of the marked positions. Tighten the grub screws using a 1/4" Allen Key. NB If further extension panels are to be used then replace 2no. (10-5) Single Socket Tee for 2No. (26-5) Two Socket Cross fittings. This will permit further panels to be connected to the panel.

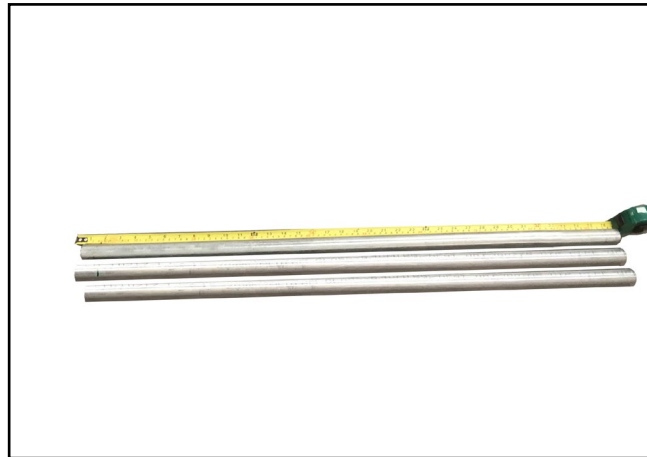

D. Select the 3No. 925mm lengths of tube and insert each of the tubes into the (10-5) Single Socket Tee mounted on the length of size 5 tube (3000mm). Tighten the grub screws using a 1/4" Allen Key. This will now form a large rectangle (Frame).

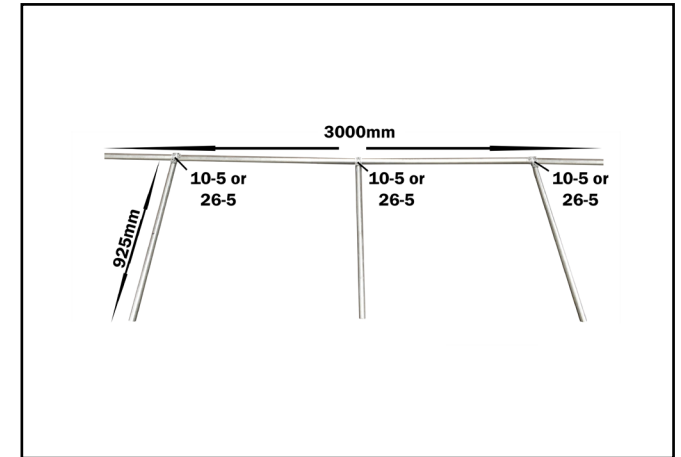

E. See diagram above to ensure frame is formed correctly.

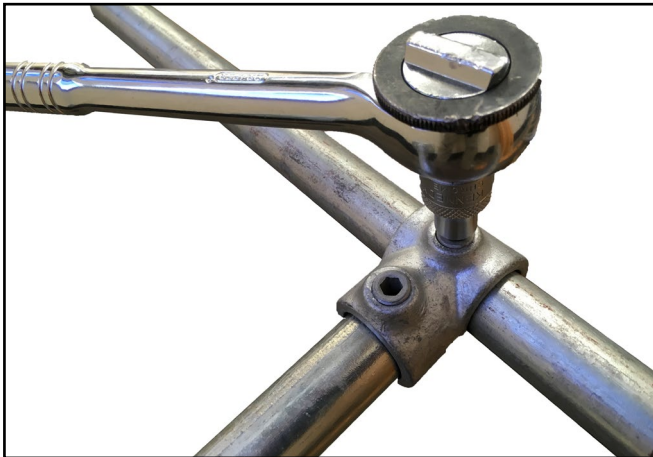

F. Using a 1/4" Allen Key ensure all grub screws are finally tightened.

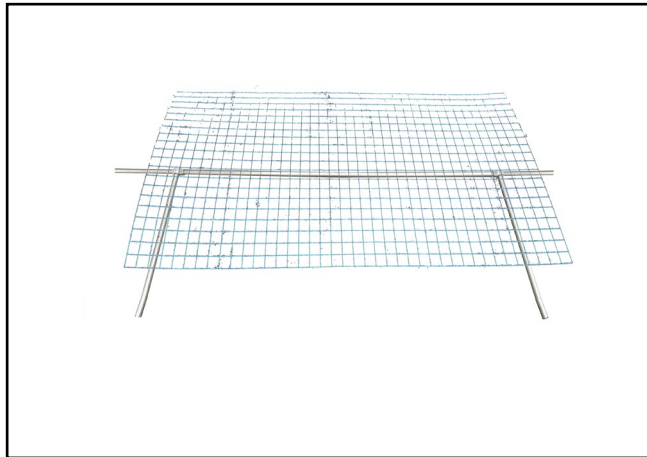

G. Carefully overlay mesh panel onto the frame. The mesh panel will be slightly larger than the frame itself.

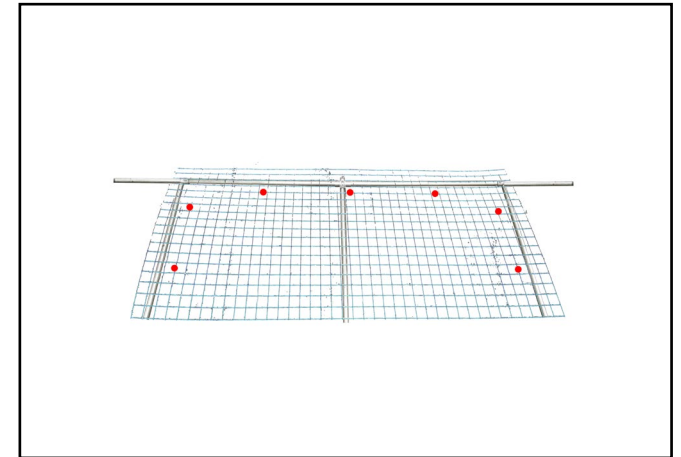

H. To connect the Mesh Panel and Frame together with the 10No. (81-5) Single Sided Clips position the Single Sided Clips as per diagram above.



I. Mesh panel clips are to be attached as above diagram.

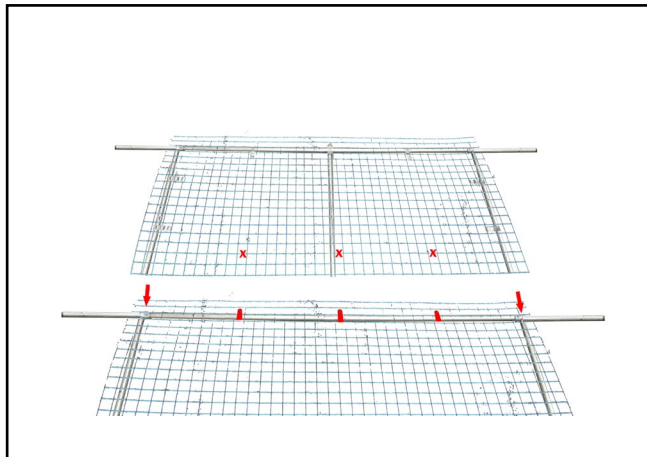

J. Insert extension panel tube ends into 26-5 of primary screen, slight lifting of the mesh may be required as there will be a slight overlap. Tighten grub screws. Secure extension mesh to primary panel by attaching 3no. mesh panel clips (shown in red) onto existing screen, then secure mesh to extension panel where red 'X' is shown.



K. Slide 1No. Rail Flange fitting over each end of the exposed tube in the corners of the frame. Carefully align the fitting to ensure it is positioned on the crown of roof sheet.

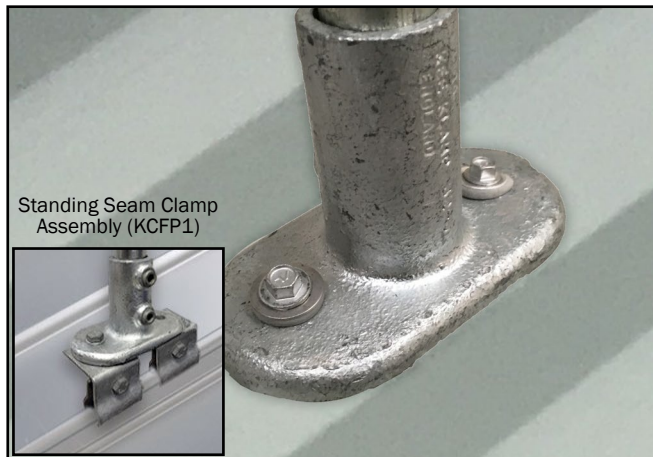

Standing Seam Clamp
Assembly (KCFP1)

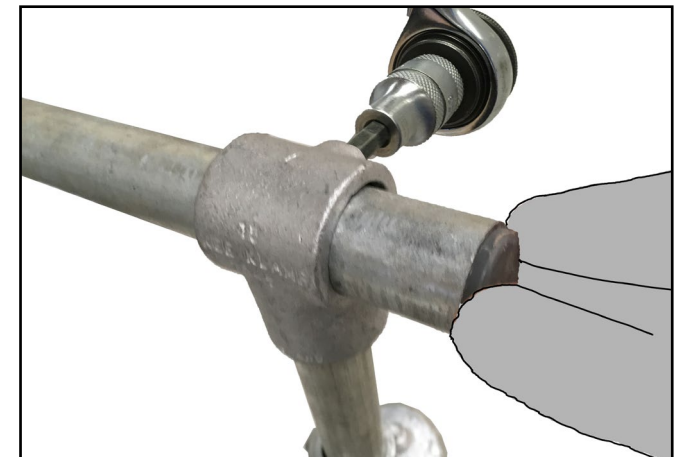
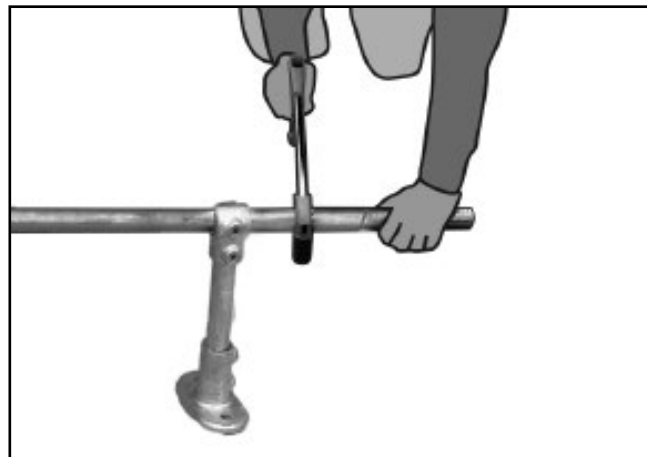

L. Carefully cut 6No. 120mm lengths of sealing strip. Place the Sealing Strip between the 6No. Standard Rail Flange fittings and the roof structure. Use Self Drilling Screws (SDS55X550) to attach the screen onto the roofing sheet. NB If attaching to standing seam roof use KCFP1 clamps to connect to the standing seam and bolt the 62-5 fitting to the KCFP1 clamp as shown in the diagram.

M. To avoid the risk of trip hazards from exposed tubing use a hacksaw or similar carefully cut through the excess lengths of tubes as shown, leaving approximately 50mm of tube exposed. For galvanised assemblies, spray with Galvafoid or similar to prevent corrosion.

N. Using a 1/4" Allen key/torque wrench ensure all fittings are torqued to 39Nm. Place plastic end caps on exposed ends of tubes to ensure minimal water ingress.

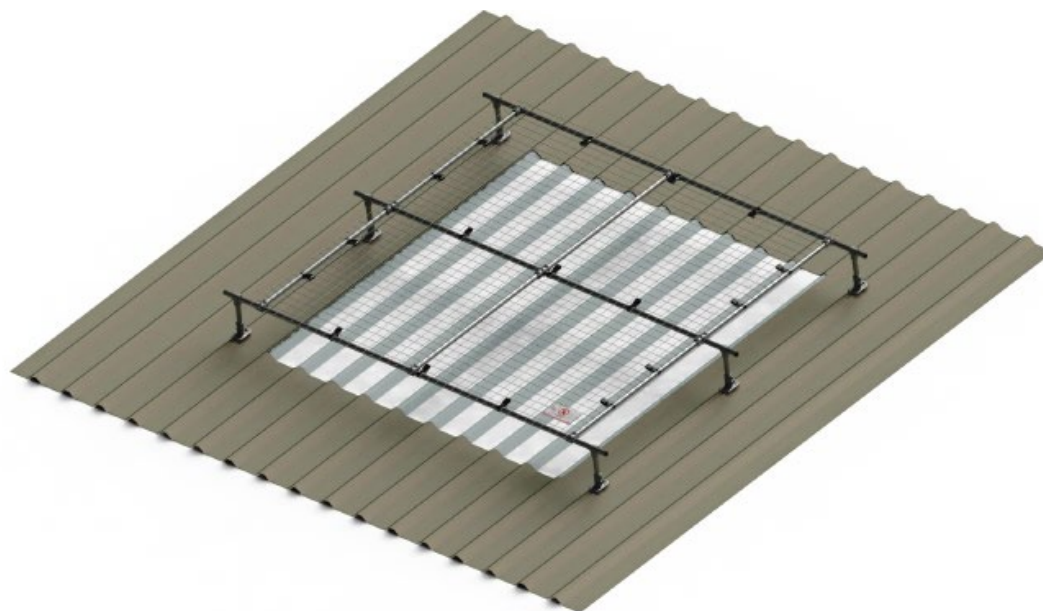

Note:- Installing Kee Cover:- Working at height is dangerous and skylights may not be suitable to bear any weight. When installing Kee Cover always use appropriate fall protection equipment!

Periodic inspections by a competent person are recommended by the manufacturer. In UK/Europe these are required under Regulation 5 of the Workplace (Health, Safety & Welfare) Regulations, the Work at Height Regulations and Provision and Use of Work Equipment Regulations.

The frequency will depend upon the environment, location and usage but should be at least every 12 months.

- Visually inspect the complete installed product in relation to the general client's needs. Establish if any modifications and/or additional products are required to reflect any refurbishment requirements or additional plant & equipment which have been installed and require material access.
- Check installation configuration is complete as per the original installation drawing/plan.
- Ensure the product has not been modified or tampered with by unauthorised persons.
- Check the functionality of the product.
- Check all fixings are in place and sufficiently torqued.
- Check the general height and level of the product.
- Any galvanised components showing signs of corrosion should be wire brushed thoroughly and galvanised spray/paint applied as appropriate. If rusted significantly, take digital photographs and include these in the inspection report.
- Inspect powder coated product surfaces and note any imperfections or general degradation.
- Check fixings to structures are sufficiently torqued.
- Check system plaque position & mark up to reflect date of the next required inspection. Establish if additional plaques are required due to any refurbishment works.



Kee Safety Singapore Pte Ltd
38 Ang Mo Kio Industrial Park 2
#01-03, Singapore 569511

Tel.: +65 6385 4166
Email: sgsales@keesafety.com
Website: keesafety.sg